

MARINE PRODUCT DATA SHEET

OEM 2088-762-234
 AFTERMARKET 2088-574-734



Pro Baitmaster



TYPICAL APPLICATIONS

Marine bait and livewell installations. Other uses may include 24 VDC pressurized water systems. This pump may be used for general water transfer. For other applications, contact SHURflo.

PUMP

Type: 3 Chamber Diaphragm
 Ports: 1/2"-14 NPSM-Male
 Liquid: 130 °F [54 °C] Max
 Prime: 6 feet [1.82 M]
 Inlet PSI: 30 PSI [2.1 Bar] Max
 Run Dry: Yes

ELECTRICAL

Motor: 24VDC Permanent Magnet, Continuous Duty (See T-Rise Chart)
 Protection: Thermal Overload, Automatic Restart
 Leads: 14 AWG, 36" [40 cm] Red +, 38" [33 cm] Black -
 Fuse: 15 Amp Recommended
 Control: Adjustable Switch with Check Valve
 Shut-Off 45 PSI [3.1 Bar] ± 5 PSI [0.4 Bar]
 Restart 25 PSI [1.8 Bar] ± 5 PSI [0.4 Bar]

MATERIALS

Housing: Polypropylene
 Valves: EPDM
 Diaphragm: Santoprene
 Hardware: Stainless Steel

APPROVALS

UL Marine, Ignition Protected, ISO 8846, c-UL

WARRANTY

2 Year Limited Warranty
 See SB-1050 For Full Warranty Details

SHIPPING

Net Weight (Boxed): 7 Lb [3.2Kg] each
 Carton Weight: 6 each, 42 Lb [24 Kg]
 Carton Size: 24"L x 11"W x 6"H
 [61cm x 28cm x 16cm]

RELATED DOCUMENTS

Catalog: MS-030-084
 Installation Manual: 911-391
 Maintenance: 911-391
 Applications Spec Guide: MS-020-005
 Warranty: SB-1050

Parts Kits

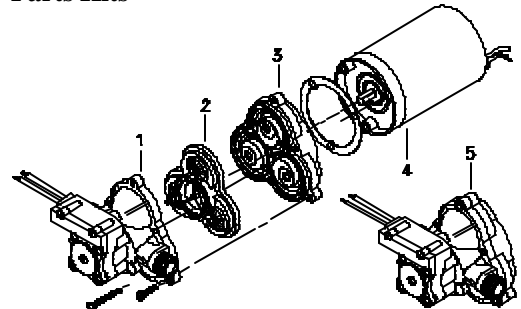

Number	Component	Parts Kit
1	Housing/Switch	94-231-10
2	Valve Assembly	94-232-06
3	Drive Assembly	94-238-03
4	Motor	77-004-07
5	Pump Head	94-236-14
Not Shown	Check Valve	94-237-00



MARINE PRODUCT DATA SHEET

OEM 2088-762-234
 AFTERMARKET 2088-574-734



TYPICAL PERFORMANCE @ 24V DC

PRESSURE		FLOW		CURRENT
BAR	PSI	GPM	LPM	AMPS
0.0	0	3.6	13.6	4.5
0.7	10	2.9	10.9	5.6
1.4	20	2.6	9.8	7.1
2.1	30	2.3	8.7	8.4
2.8	40	2.0	7.5	9.0

TYPICAL MOTOR SHELL T-RISE @ 45 PSI, 12V

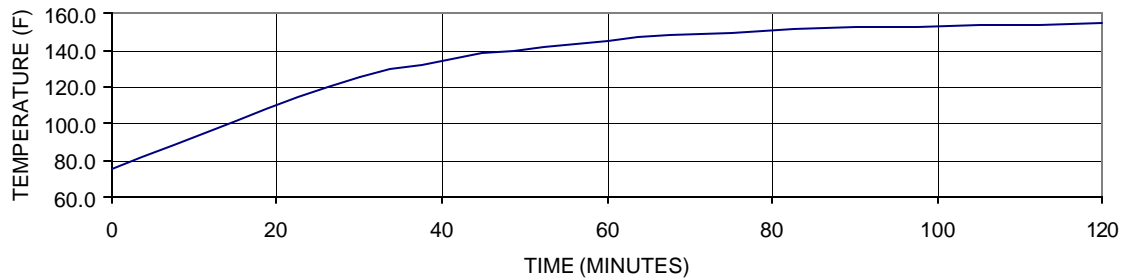

DIMENSIONS [mm]

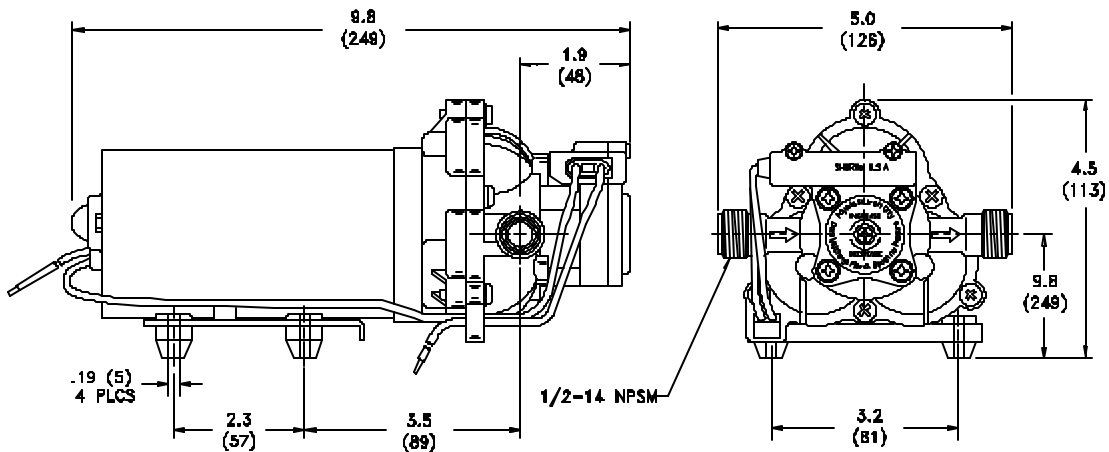

*ISO Registered Facility

SHURflo reserves the right to update specifications, prices, or make substitutions.

SHURflo *
 5900A Katella Ave.
 Cypress, Ca. 90630
 (800) 854-3218 (562) 795-5200
 FAX (562) 795-7554
 Shipping/UPS: 5900C Katella Ave.
 Cypress, Ca. 90630

SHURflo East
 52748 Park Six Court
 Elkhart, IN 46514-5427
 (800) 762-809 (574) 262-0478
 FAX (574) 264-2169
 Http://www.shurflo.com
 © 2001

SHURflo Ltd. *
 Unit 5 Sterling Park
 Gatwick Road, Crawley
 West Sussex, RH10 2QT
 United Kingdom
 +44 1293 424000
 FAX +44 1293 421880

