

# Performance Curves

## 1750 RPM

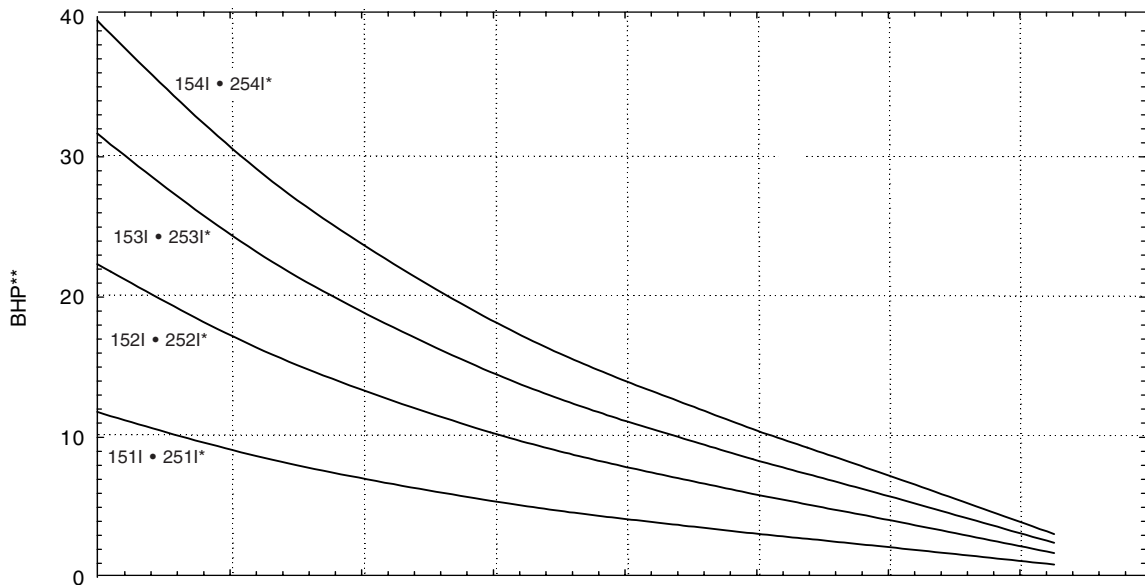
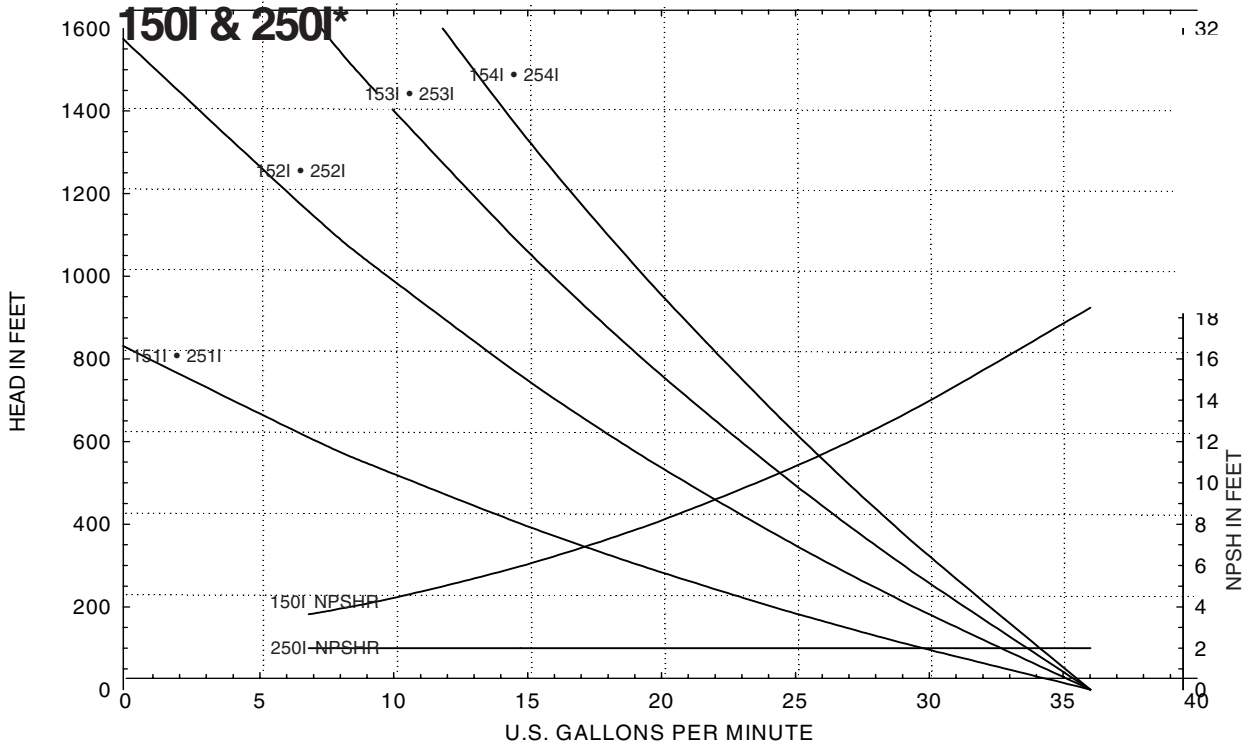

**NOTES**

Do not exceed 150 feet TDH with 1.0 S.G. fluids  
 Consult factory for operation below 4.0 GPM  
 \*Add 1 horsepower for 250 Series models  
 \*\*Horsepower is valid for 1.0 specific gravity fluids only

**MTH PUMPS**  
 401 WEST MAIN STREET • PLANO, IL 60545-1436  
 PHONE: 630-552-4115 • FAX: 630-552-3688



# Performance Curves

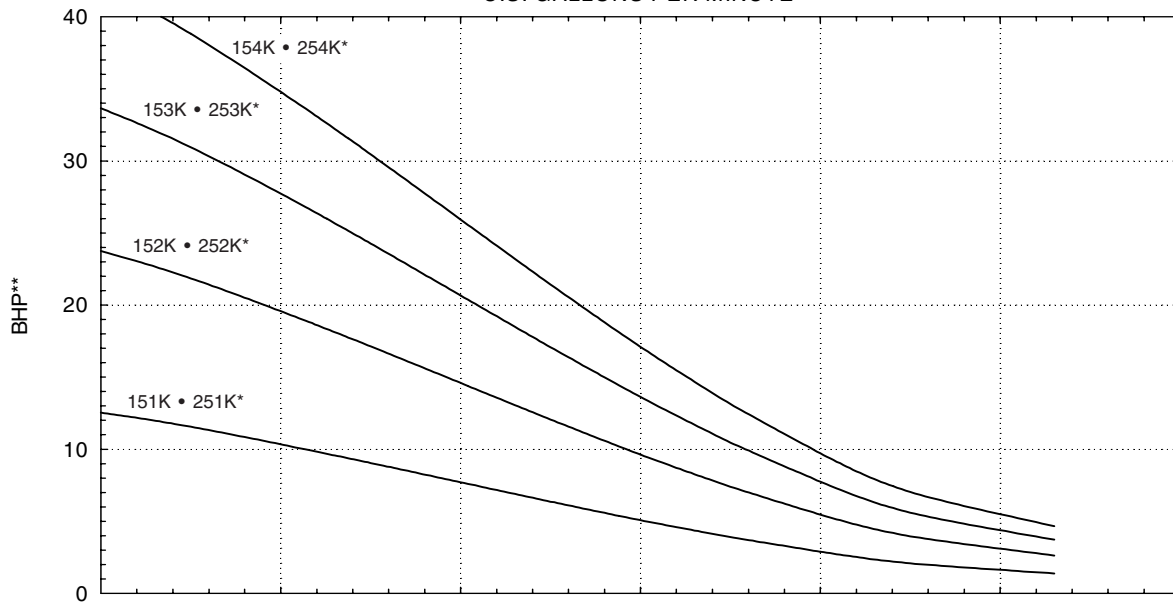
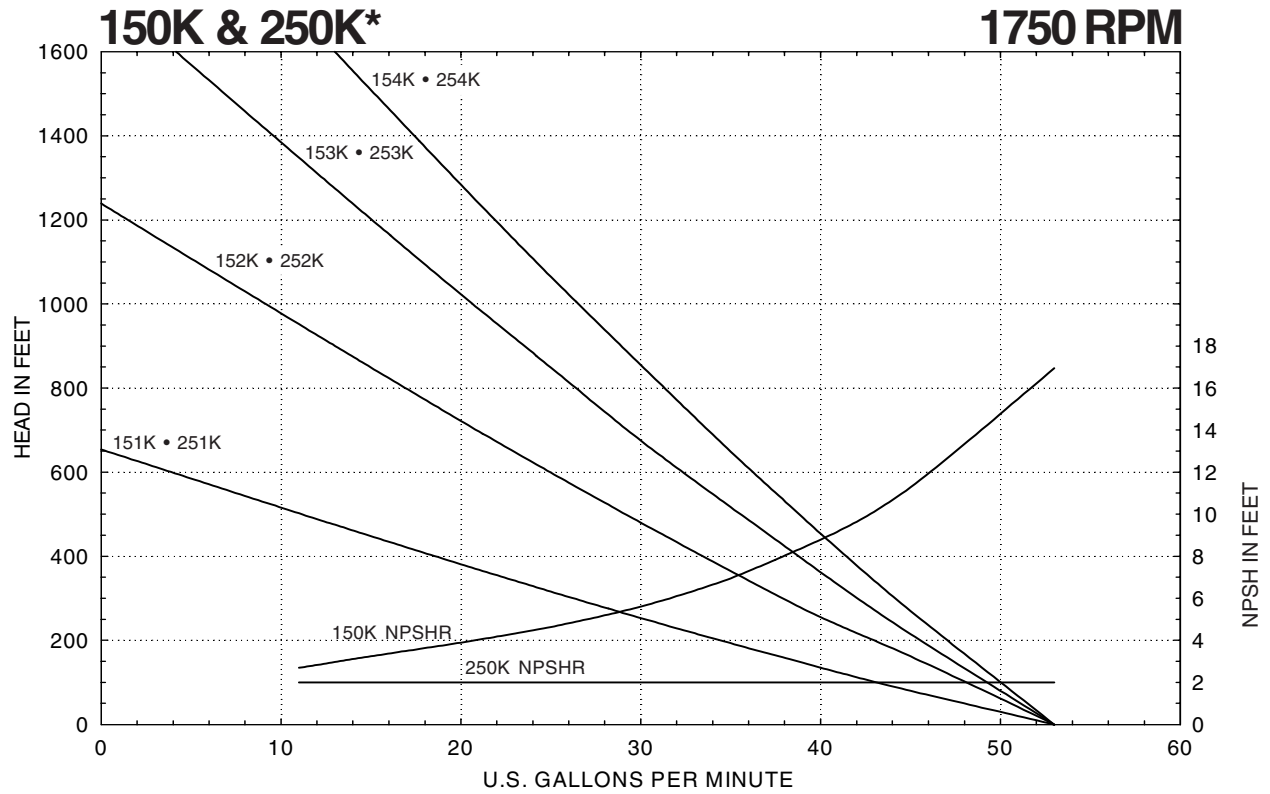

**NOTES**

Do not exceed 1150 feet TDH with 1.0 S.G. fluids  
 Consult factory for operation below 21.0 GPM  
 \*Add 1 horsepower for 250 Series models  
 \*\*Horsepower is valid for 1.0 specific gravity fluids only

# Performance Curves

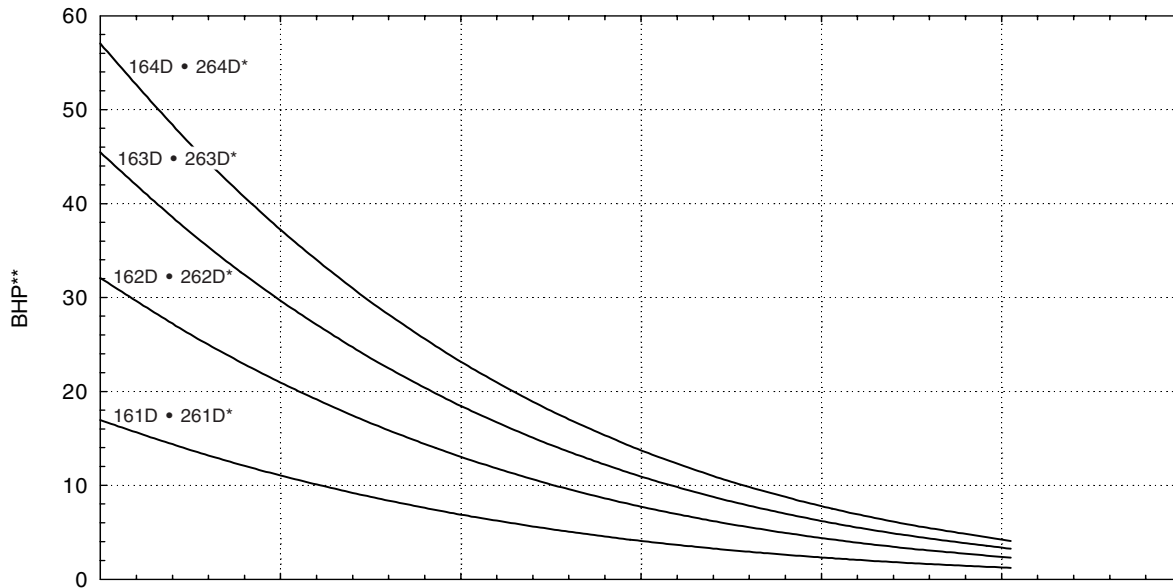
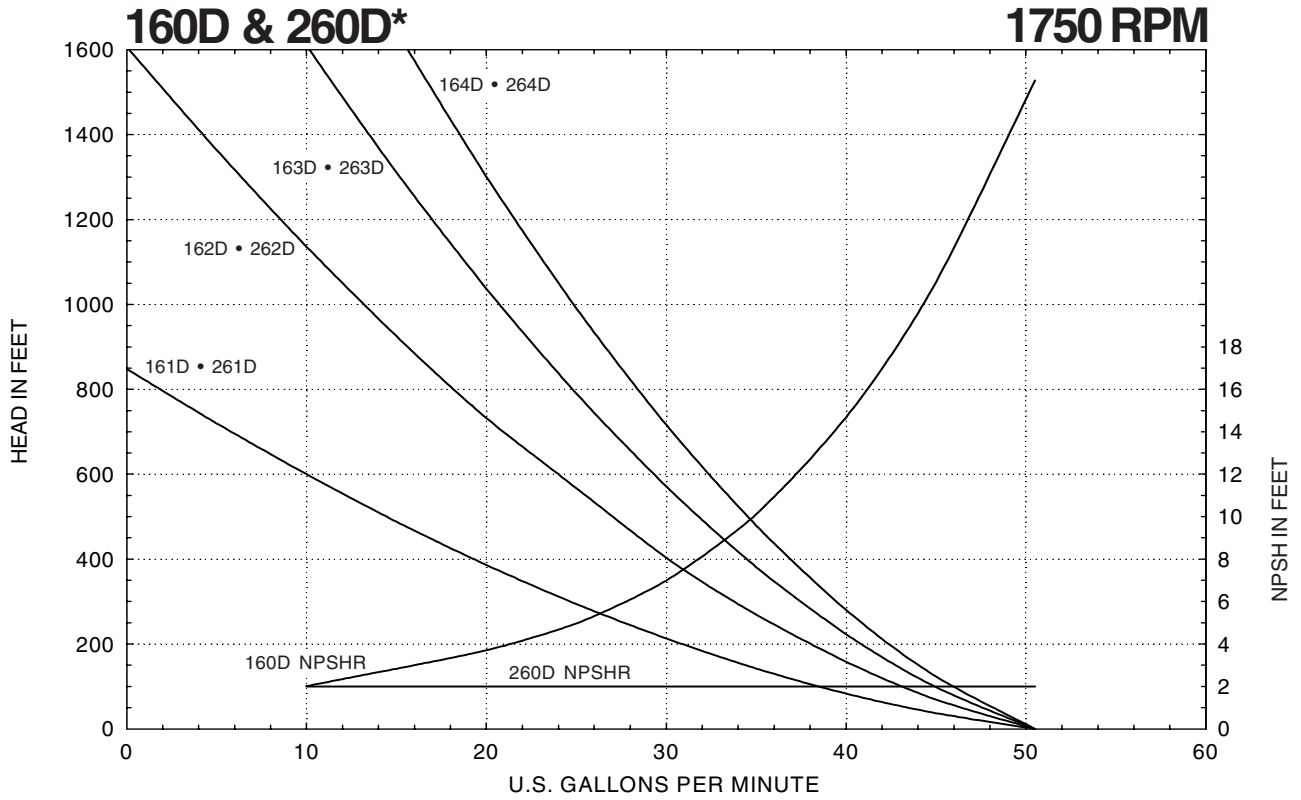

**NOTES**

Do not exceed 1150 feet TDH with 1.0 S.G. fluids  
 Consult factory for operation below 20.0 GPM  
 \*Add 1 horsepower for 260 Series models  
 \*\*Horsepower is valid for 1.0 specific gravity fluids only

# Performance Curves

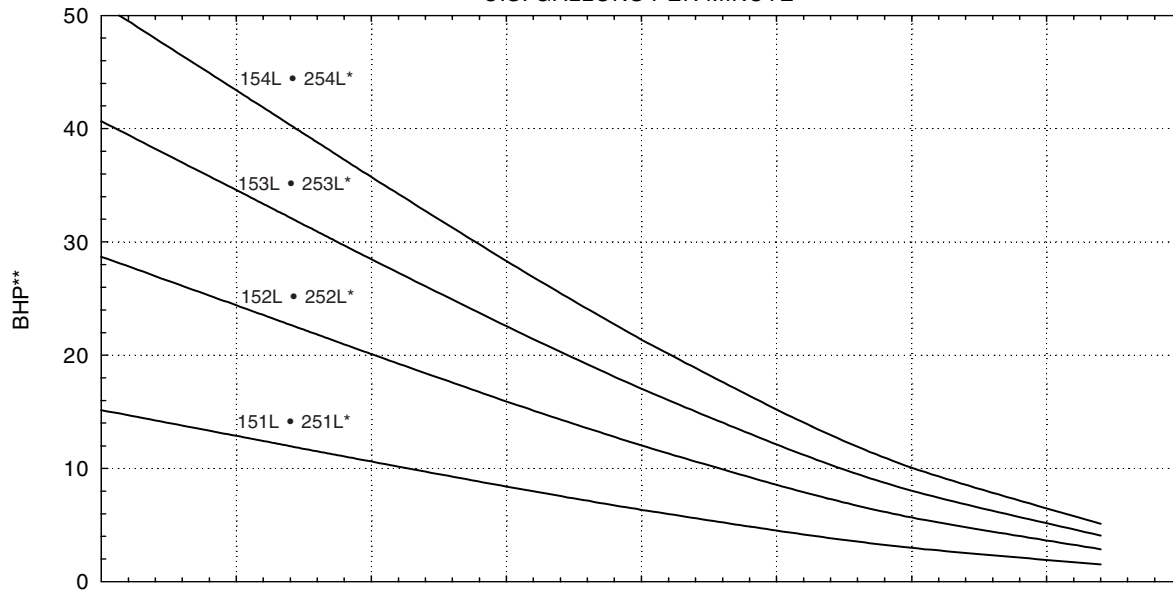
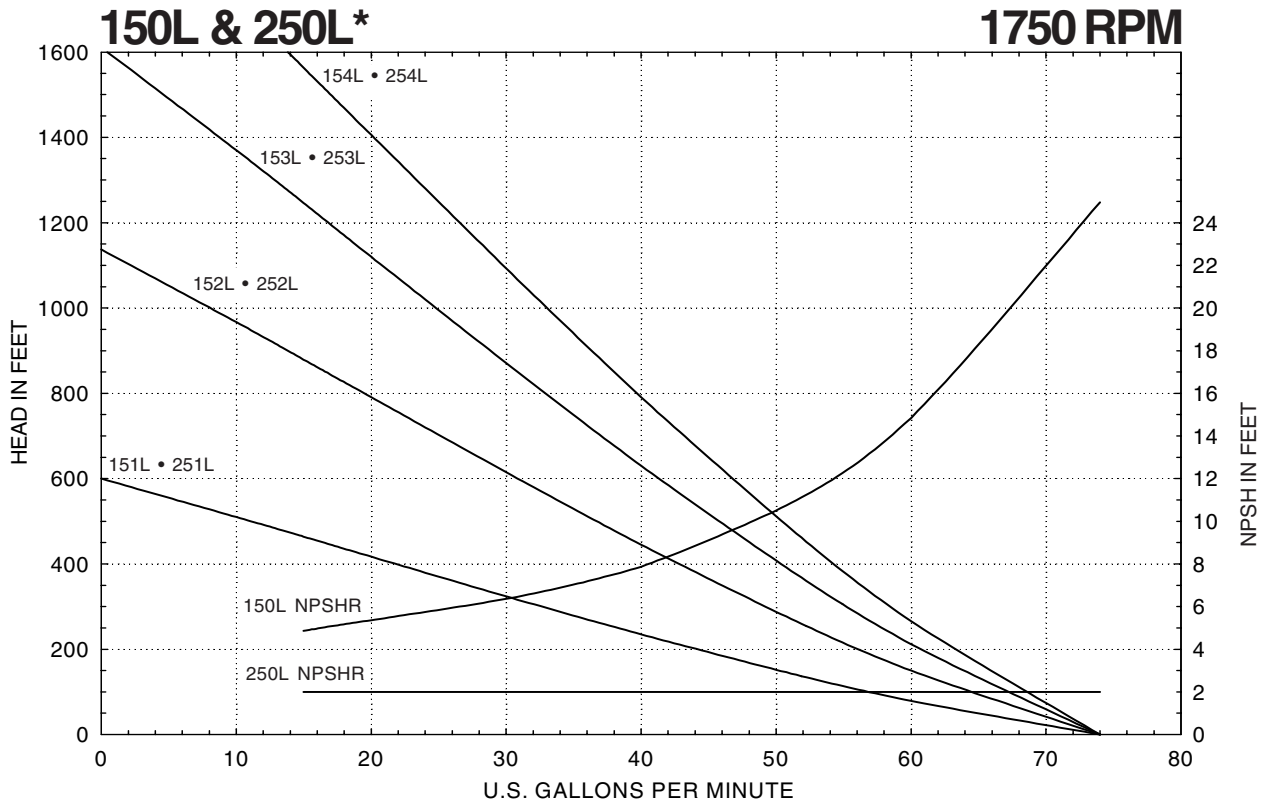

**NOTES**

Do not exceed 1150 feet TDH with 1.0 S.G. fluids  
 Consult factory for operation below 29.0 GPM  
 \*Add 1 horsepower for 250 Series models  
 \*\*Horsepower is valid for 1.0 specific gravity fluids only

**NOTES**

Do not exceed 1150 feet TDH with 1.0 S.G. fluids  
 Consult factory for operation below 29.0 GPM  
 \*Add 1 horsepower for 250 Series models  
 \*\*Horsepower is valid for 1.0 specific gravity fluids only

# Performance Curves

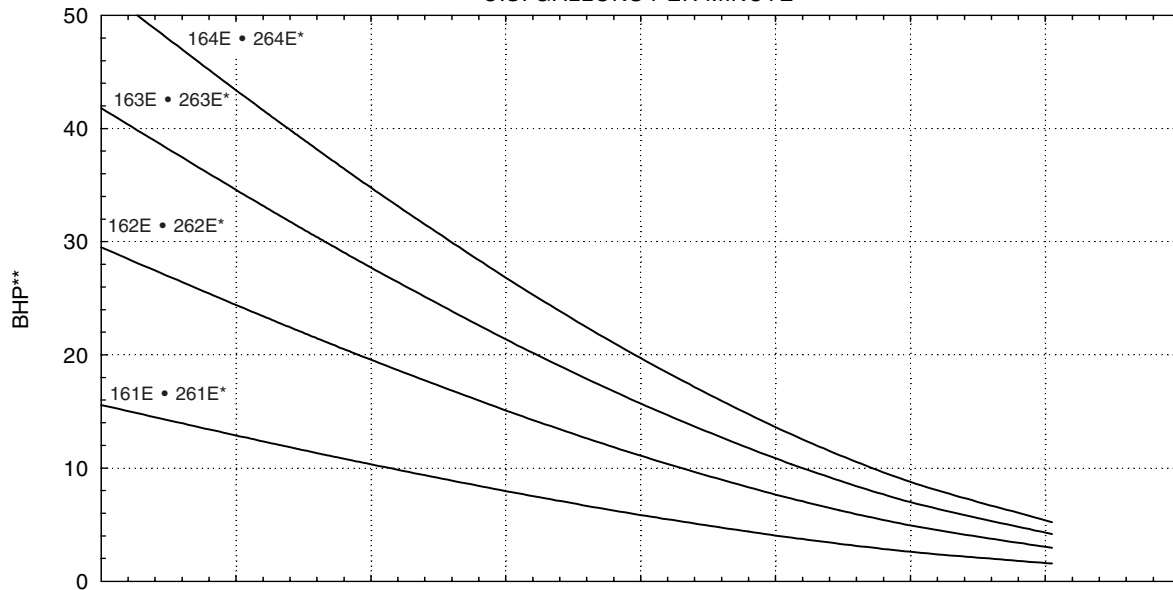
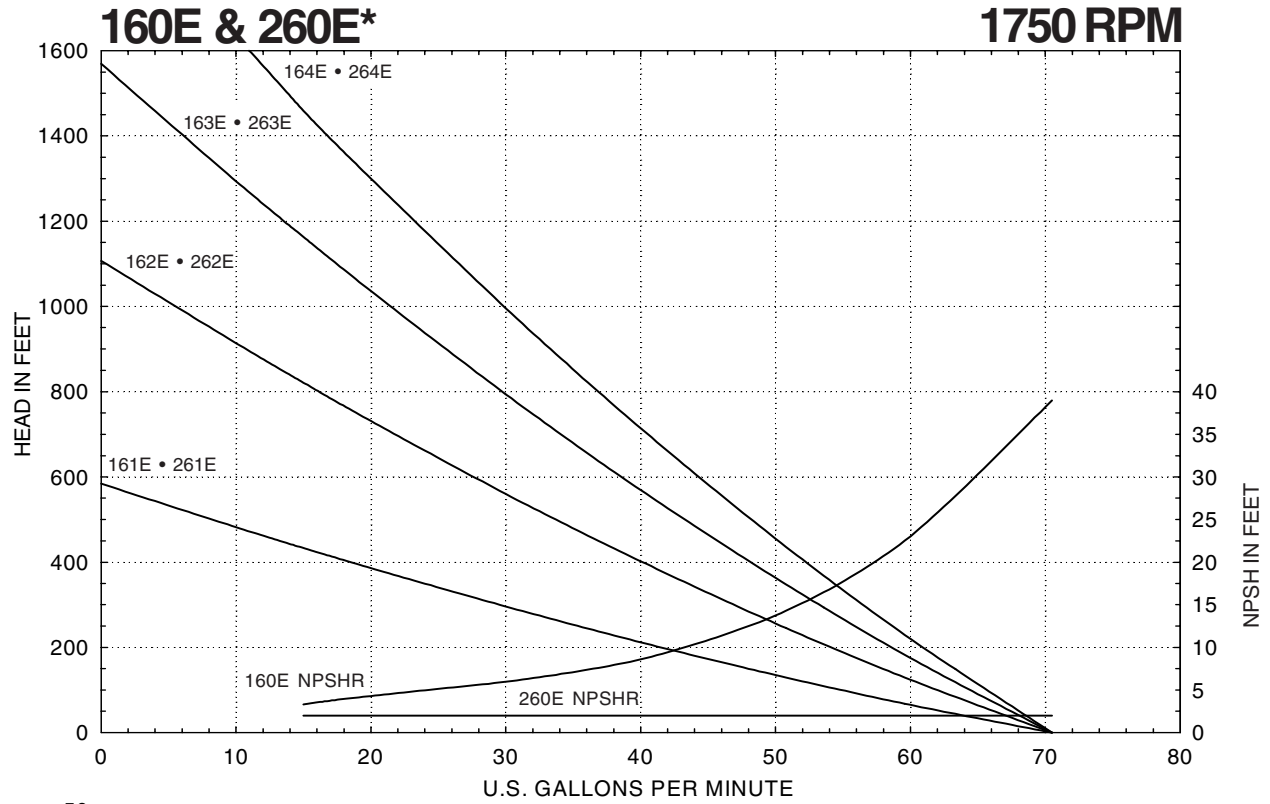

**NOTES**

Do not exceed 1150 feet TDH with 1.0 S.G. fluids  
 Consult factory for operation below 28.0 GPM  
 \*Add 1 horsepower for 260 Series models  
 \*\*Horsepower is valid for 1.0 specific gravity fluids only

# Performance Curves

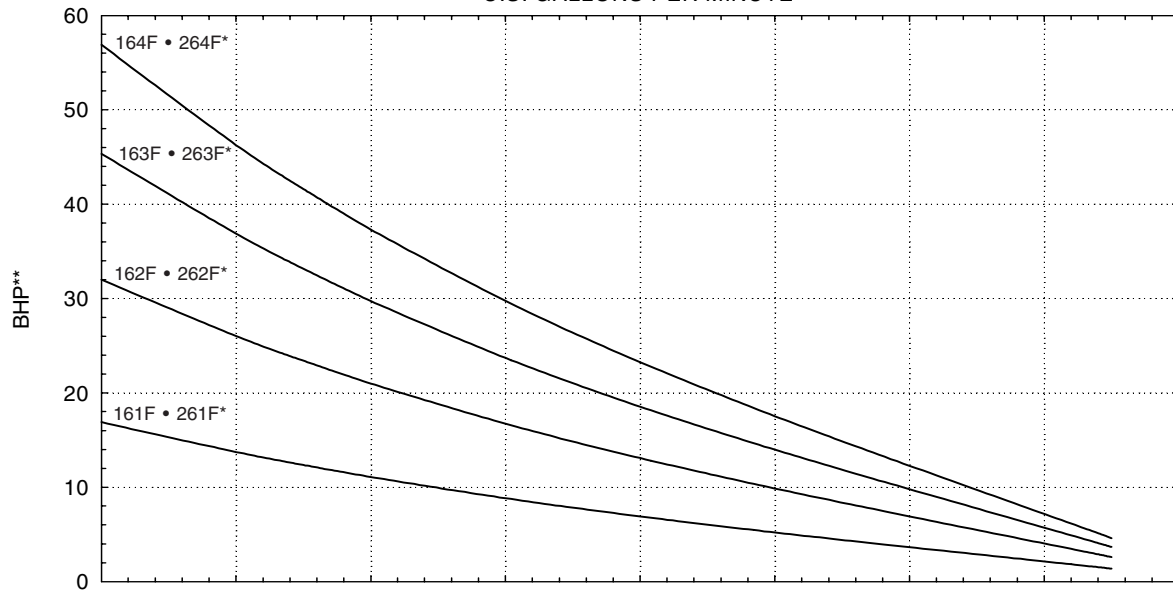
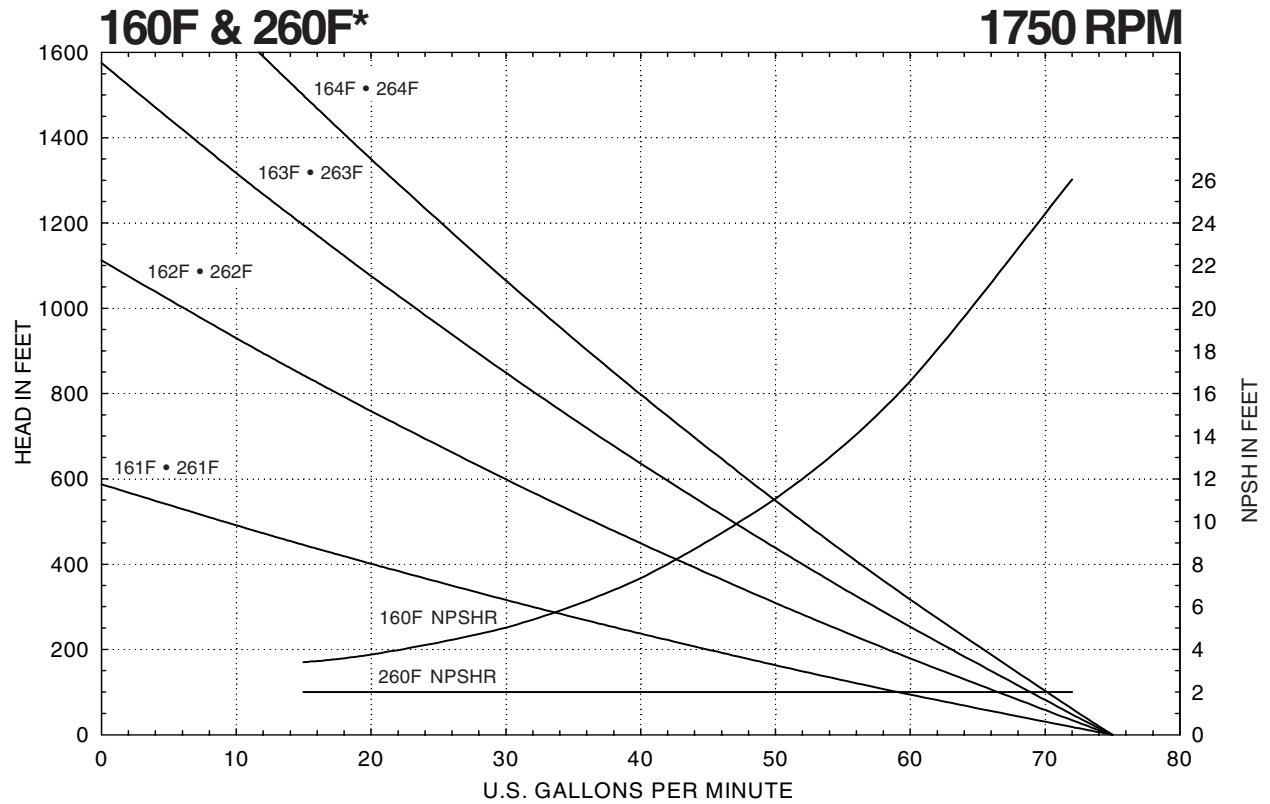

**NOTES**

Do not exceed 1150 feet TDH with 1.0 S.G. fluids  
 Consult factory for operation below 29.0 GPM  
 \*Add 1 horsepower for 260 Series models  
 \*\*Horsepower is valid for 1.0 specific gravity fluids only

# Performance Curves

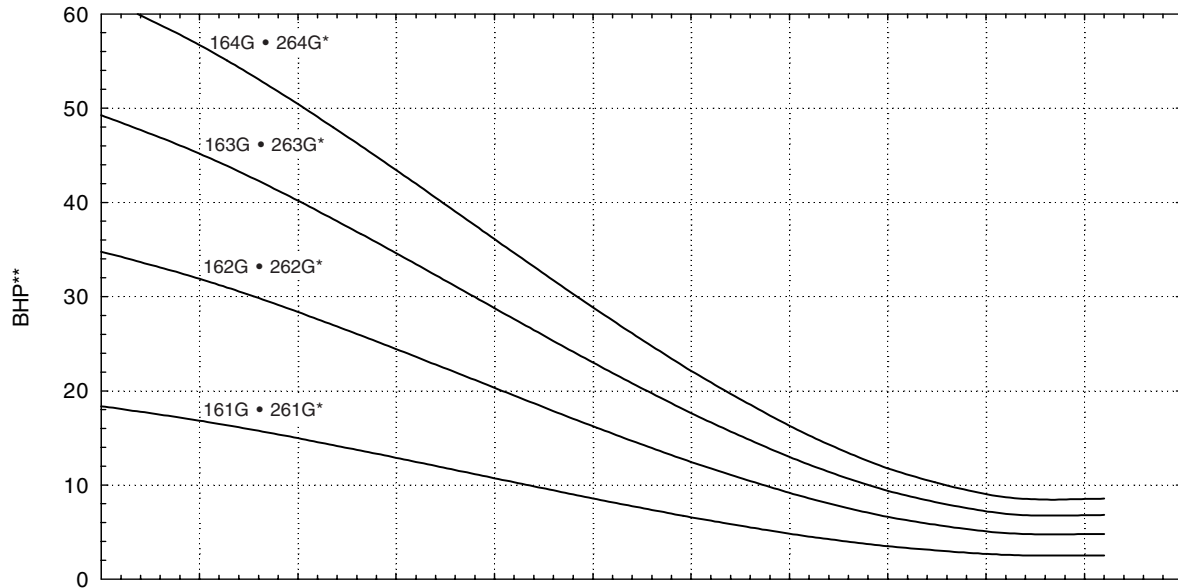
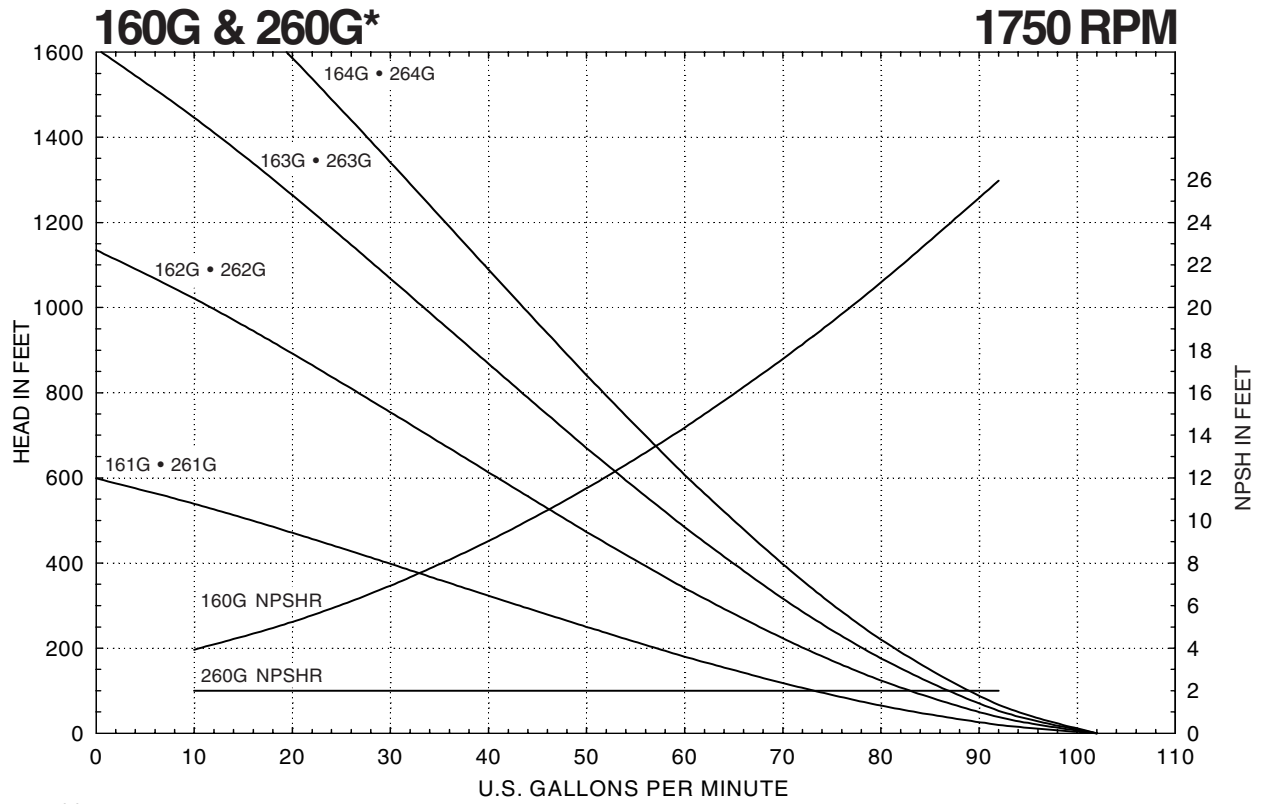

**NOTES**

Do not exceed 1150 feet TDH with 1.0 S.G. fluids  
 Consult factory for operation below 40.0 GPM  
 \*Add 1 horsepower for 260 Series models  
 \*\*Horsepower is valid for 1.0 specific gravity fluids only

# Performance Curves

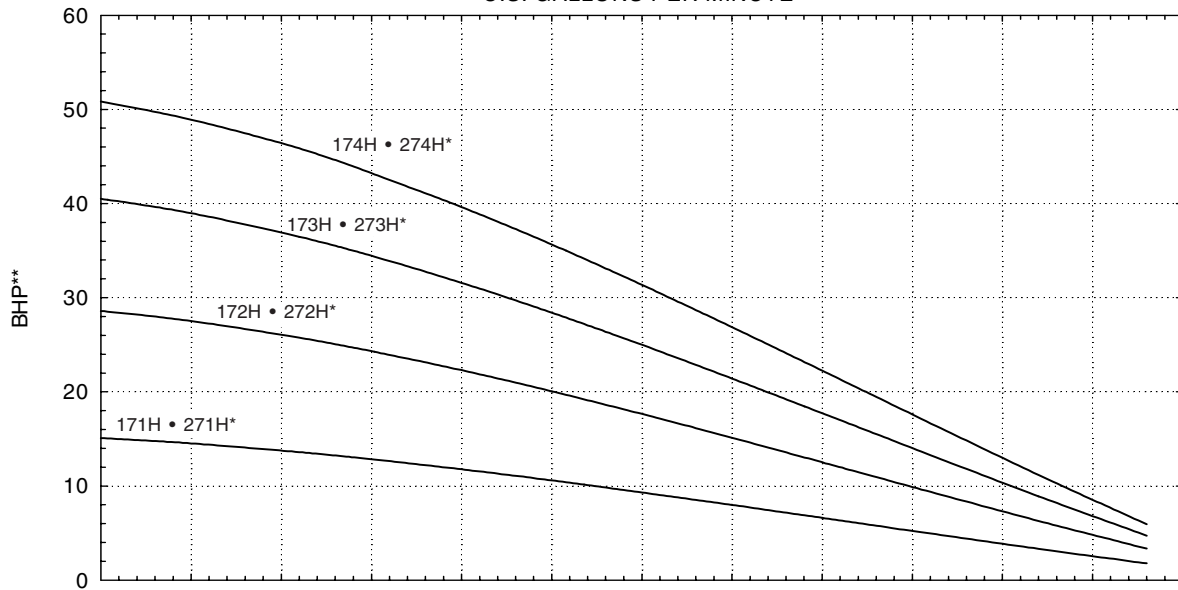
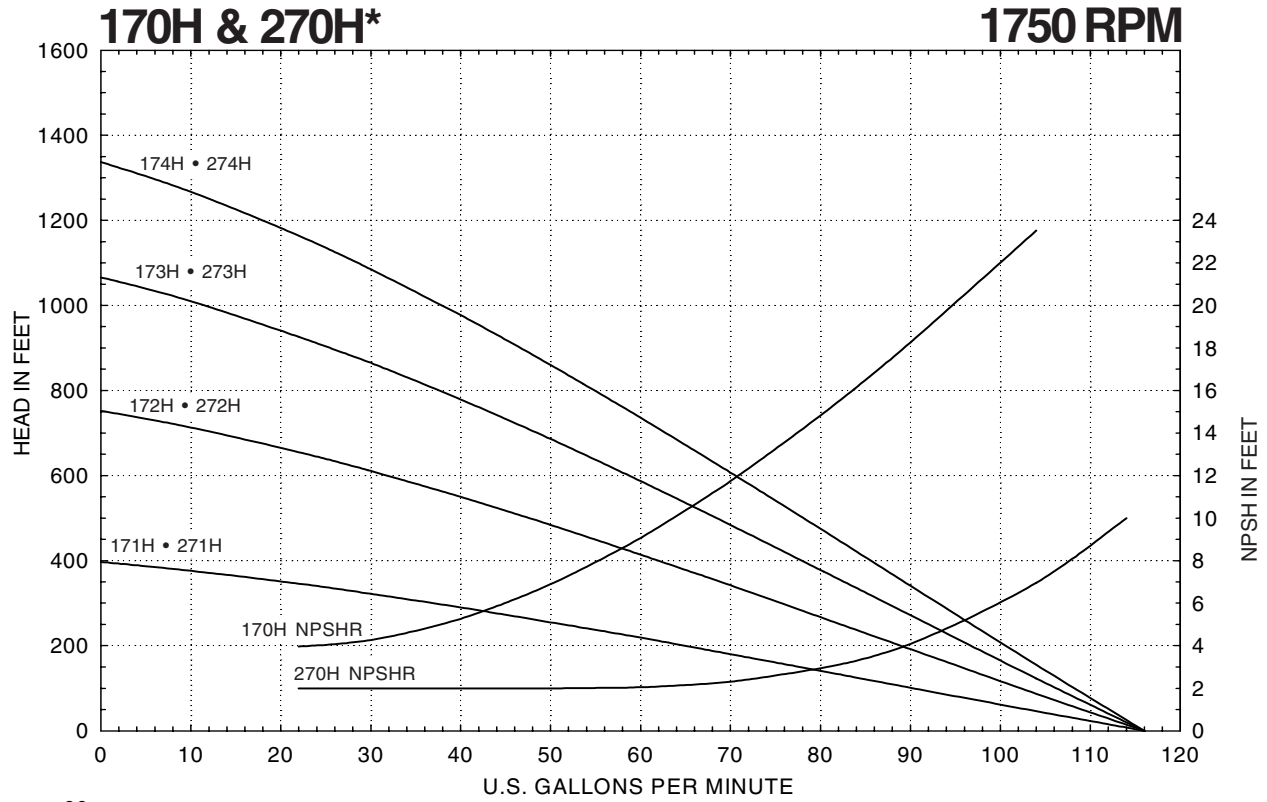

**NOTES**

Do not exceed 1150 feet TDH with 1.0 S.G. fluids  
 Consult factory for operation below 46.0 GPM  
 \*Add 1 horsepower for 270 Series models  
 \*\*Horsepower is valid for 1.0 specific gravity fluids only

# Performance Curves

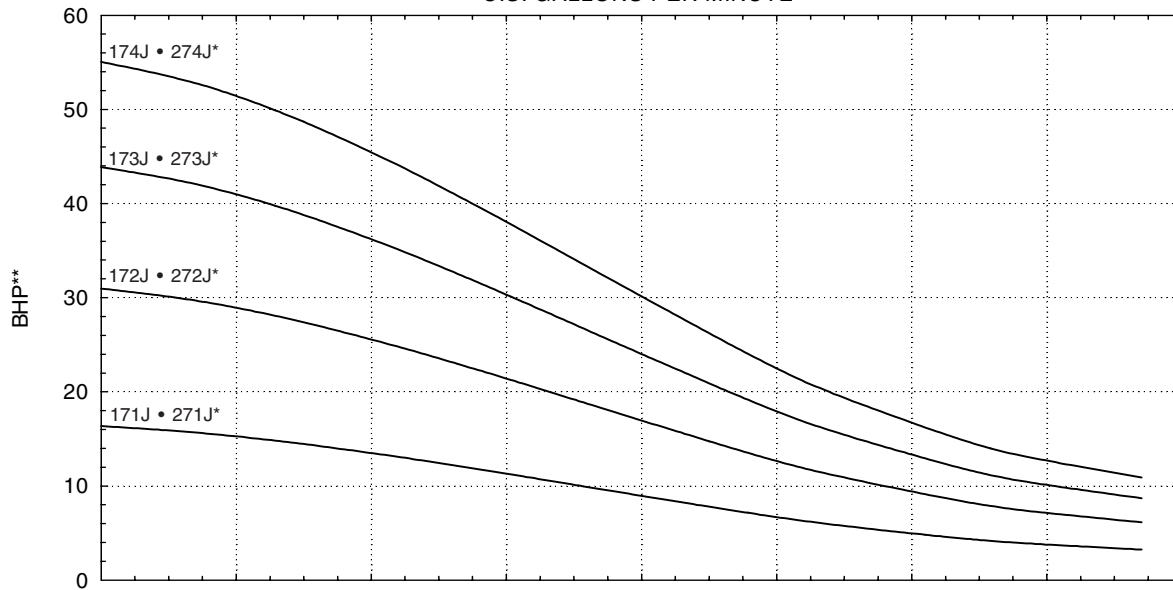
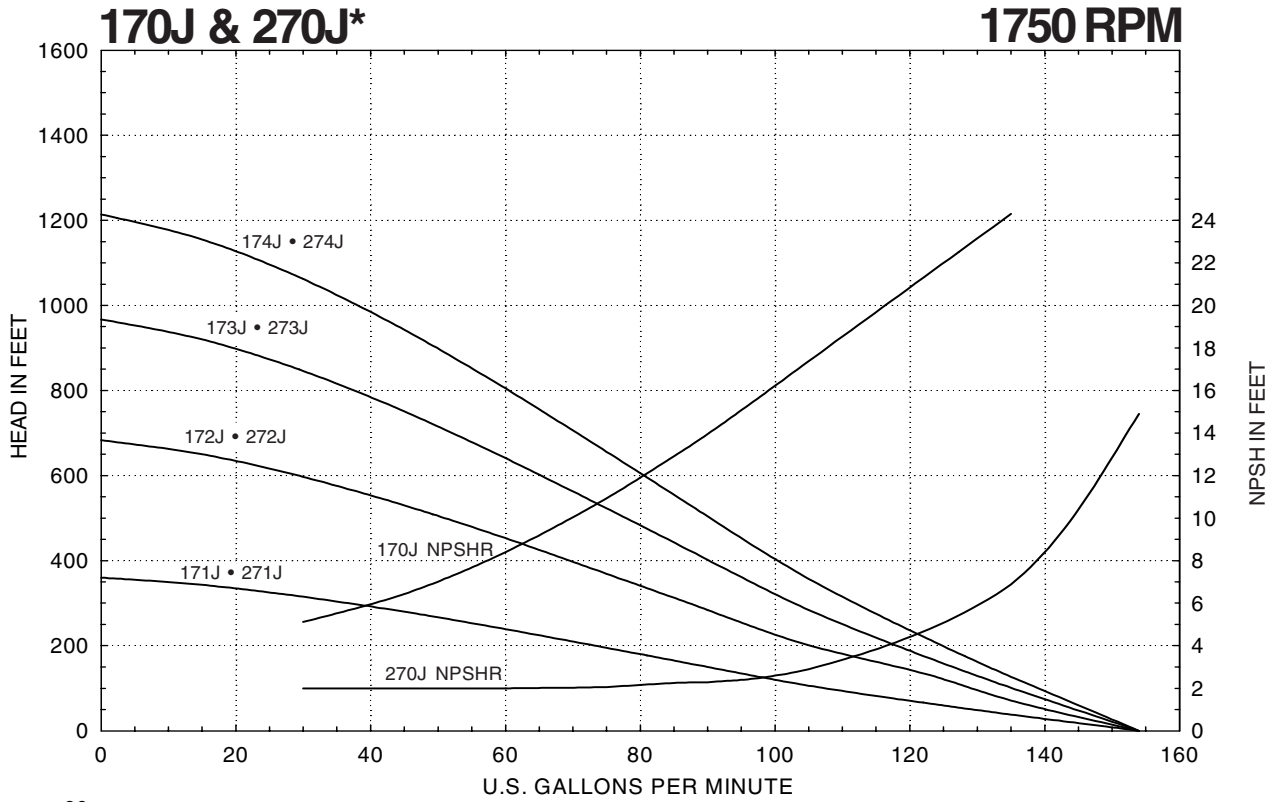

**NOTES**

Do not exceed 1150 feet TDH with 1.0 S.G. fluids  
 Consult factory for operation below 62.0 GPM  
 \*Add 1 horsepower for 270 Series models  
 \*\*Horsepower is valid for 1.0 specific gravity fluids only

# Performance Curves

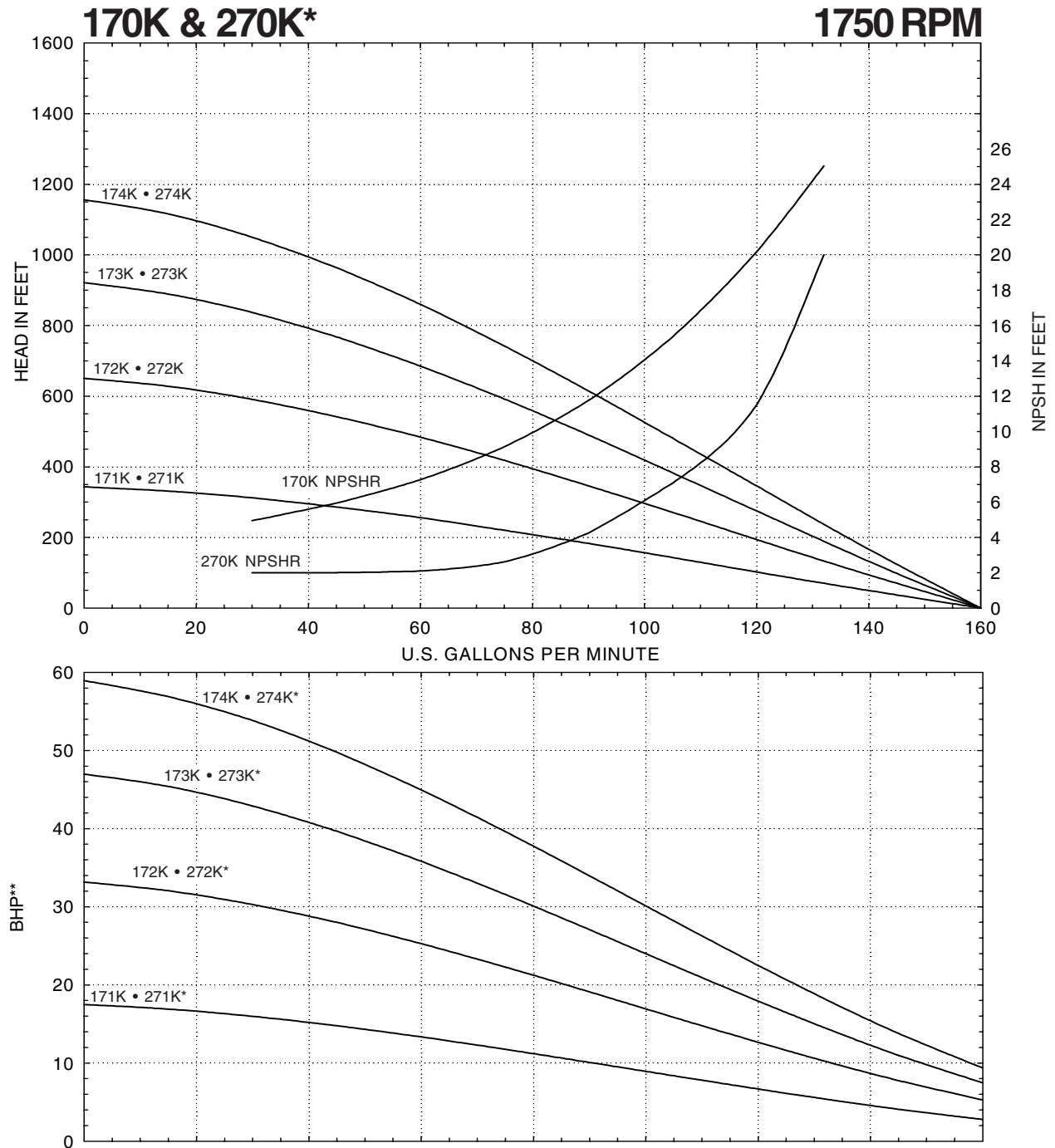

**NOTES**

Do not exceed 1150 feet TDH with 1.0 S.G. fluids  
 Consult factory for operation below 64.0 GPM  
 \*Add 1 horsepower for 270 Series models  
 \*\*Horsepower is valid for 1.0 specific gravity fluids only

**MTH PUMPS**  
 401 WEST MAIN STREET • PLANO, IL 60545-1436  
 PHONE: 630-552-4115 • FAX: 630-552-3688

