

IRRIGATION & INDUSTRIAL EP SERIES

EP

EP SERIES END SUCTION CENTRIFUGAL PUMPS

The EP Series end suction centrifugal pumps are of a rugged cast iron design. Suitable for a wide variety of markets including irrigation, industrial, commercial and marine. These pumps are engineered to provide you with long reliable service.

CASING - Ductile iron casing with reinforcing ribs for higher working pressures and greater resistance to water hammer.

IMPELLER - Vacuum cast bronze impeller provides smooth flow passages for improved performance. Cast iron impellers

are also available. All impellers are dynamically balanced, with hydraulic balancing included on larger models.

SEALS - Frame mount and JP motor driven pumps are available with either gland packing or single, double or tungsten carbide mechanical seals. JM motor driven pumps are available with single or tungsten carbide mechanical seals only. All seals are equipped standard with stainless steel springs and retainers.

SHAFT SLEEVE - Stainless steel with O-ring seal, for maximum protection against shaft corrosion.

WEAR RINGS - Provided in all pumps to prolong casing life and to allow close tolerances for improved efficiency.

SUCTION FLANGE - On all pumps for simple piping connection. A complete line of companion flanges are available to convert suction to NPT if required.

DISCHARGE FLANGE - On all models. Discharge may be rotated to eight different positions to better suit your exact requirements.

ELECTRIC MOTOR DRIVEN - Close coupled JP motors in ODP or TEFC for a compact, economical design. JM motors up to 15 HP.

FRAME MOUNT - Heavy duty bearing frame allows for belt or coupling drive, with bearings sized for improved life. A variety of frames are available for each pump, allowing you to tailor the pump to your needs.



Water Systems

Sump and Sewage

Lawn and Sprinkler

Electric Motor Driven

Engine Driven

Frame Mount

Hand Pumps

Irrigation and Industrial

EP SERIES PUMP MODEL NOMENCLATURE

EPE30M5MS-15BFTP1P

Motor, ODP JP-Frames	OP1P	1 Phase
	OP3P	3 Phase 230/460V
	OP3P5	3 Phase 575V
Motor, ODP JM-Frames	OM1P	1 Phase
	OM3P	3 Phase 230/460V
	OM3P5	3 Phase 575V
Motor, TEFC JP-Frames	TP1P	1 Phase
	TP3P	3 Phase 230/460V
	TP3P5	3 Phase 575V
Motor, TEFC JM-Frames	TM1P	1 Phase
	TM3P	3 Phase 230/460V
	TM3P5	3 Phase 575V
Metallurgy	BF	Bronze Fitted
	AI	All Iron
Electric Horsepower or Power Frame	TR1 to TR3	Transmission Size
Seal Arrangement	P	Packing
	S	Seal
	D	Double Seal
	T	Tungsten Carbide Seal
Speed	H	High speed 3525 RPM
	M	Medium speed 1750 RPM
	L	Low speed 1150 RPM
Nominal Flow	0	75 US GPM
	1	125 US GPM
	2	250 US GPM
	3	375 US GPM
	4	500 US GPM
	5	600 US GPM
Impeller Dia.	K	7½"
	M	9½"
Pump Discharge Size X 10 Inches		
Mounting Configuration	E	Electric
	T	Frame Mount

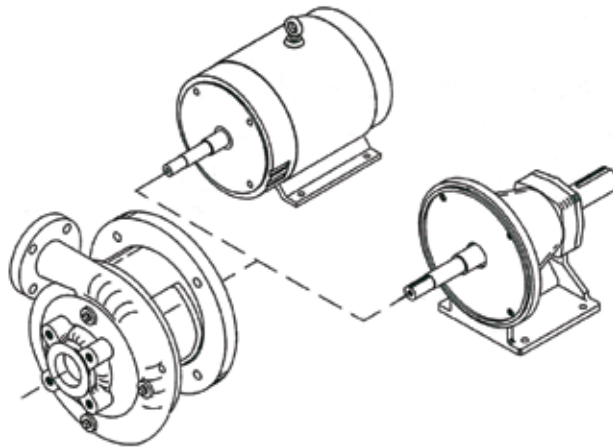

EP

Water Systems

Sump and
Sewage

Lawn and
Sprinkler

Electric Motor
Driven

Engine Driven

Frame Mount

Hand Pumps

Irrigation and
Industrial

IRRIGATION & INDUSTRIAL

EP SERIES

EP (10K0)

Water Systems

Sump and Sewage

Lawn and Sprinkler

Electric Motor Driven

Engine Driven

Frame Mount

Hand Pumps

Irrigation and Industrial

COMPLETE PUMP & MOTOR ASSEMBLY							
	Model Number	Order Number	HP	Weight (lbs.)	Phase	RPM	Size
JM FRAME	EPE10K0H	657001	3	144	3	3450	1½ x 1
		657003	5	154			
		657005	7½	209			
	EPE10K0H	657000	3	167	1	3450	1½ x 1
		657002	5	180			
	657004	7½	226				
	Model Number	Order Number	HP	Weight (lbs.)	Phase	RPM	Size
JP FRAME	EPE10K0H	657031	3	144	3	3450	1½ x 1
		657033	5	154			
		657035	7½	209			
	EPE10K0H	657030	3	167	1	3450	1½ x 1
		657032	5	180			
	Model Number	Order Number	Weight (lbs.)	TR Frame	Max Imp. Dia. @ 3450 RPM	Max RPM	Size
TR	EPT10K0M	657300	139	1	7.5"	3450	1½ x 1

PUMP END - KIT COMPONENTS				
Casing	Impeller	Seal	Adapter	Frame Size
656010	656106	656626	656516	143JM-184JM
656010	656106	656626	656516	143JM-184JM
656010	656106	656626	656518	213JM-215JM
Casing	Impeller	Seal	Adapter	Frame Size
656010	656106	656621	656512	143JP-184JP
656010	656106	656621	656512	143JP-184JP
Casing	Impeller	Seal	Adapter	TR Frame
656010	656106	656621	656512	656711

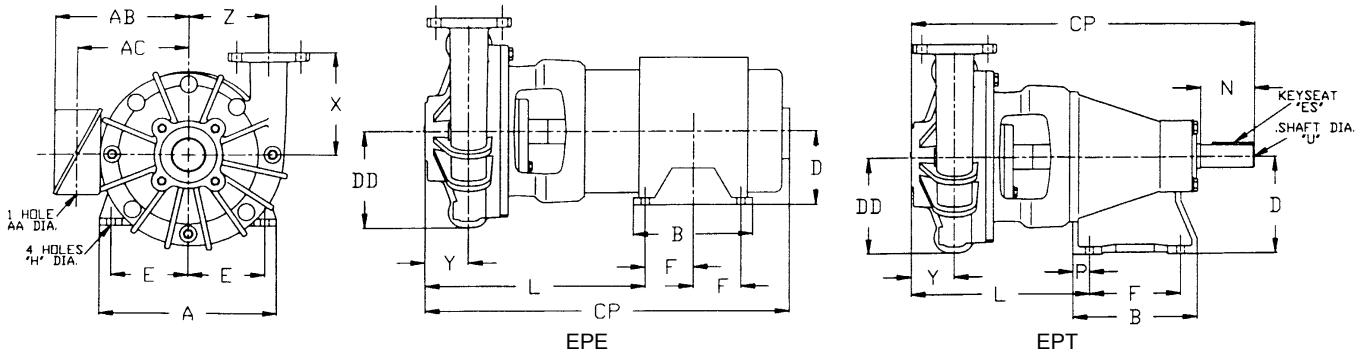

EPE10K0H 3600 RPM ODP - DIMENSIONS MEASURED IN INCHES																		
Model	HP	Flange		A	AA	AB	AC	B	CP	D	DD	E	F	H	L	X	Y	Z
		Suct.	Disch.															
10K0H	5	1.5"	1"	9.00	¾	8.12	6.48	5.75	20.44	4.50	4.90	3.75	2.25	13/32	13.25	6.50	2.47	4.12
10K0H	7.5			9.00	¾	8.12	6.48	6.75	21.44	4.50		3.75	2.75	13/32	13.25			
10K0H	10			10.50	1	9.04	7.41	7.00	24.26	5.25		4.25	2.75	13/32	15.38			

EPT10K0 - DIMENSIONS MEASURED IN INCHES																			
Model	Flange		Trans.	A	B	CP	D	DD	E	ES	F	H	L	N	P	U	X	Y	Z
	Suct.	Disch.																	
10K0M	1.5"	1"	TR-1	6.50	8.00	20.81	5.50	4.90	2.50	¼	5.38	9/16	11.06	3.00	1.21	1.125	6.50	2.47	4.12

*Standard configurations include bronze impeller, single mechanical seal, and ODP motors. For a special shaft seal, motor or impeller option, please contact factory.

IRRIGATION & INDUSTRIAL EP SERIES

EP (10K0)

- Water Systems
- Sump and Sewage
- Lawn and Sprinkler
- Electric Motor Driven
- Engine Driven
- Frame Mount
- Hand Pumps

CURVE EPE10K0H	IMPELLER Various	Date	92/01/29	
		MWP (PSI)	250	
SIZE 1.5" x 1"	SPEED 3525	Max. Solids		3/16"
		IMPELLER DIAMETERS		
		7.5 HP: 7.3" Dia.	7.5+HP: 7.5" Dia.	
		5 HP: 6.5" Dia.	5+HP: 6.7" Dia.	
		3 HP: 5.5" Dia.	3+HP: 5.8" Dia.	

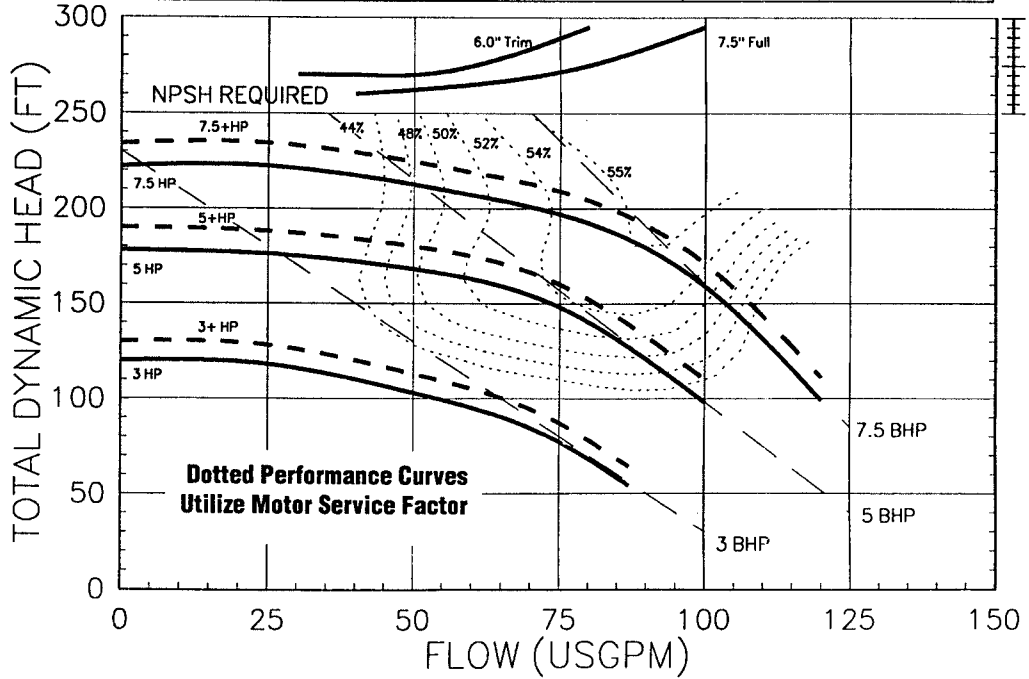

CURVE EPT10K0M	IMPELLER Various	Date	92/01/29	
		MWP (PSI)	250	
SIZE 1.5" x 1"	SPEED 1750	Max. Solids		3/16"
		FRAME SELECTION		
		TR-1 UP TO 7.5" Diam.		

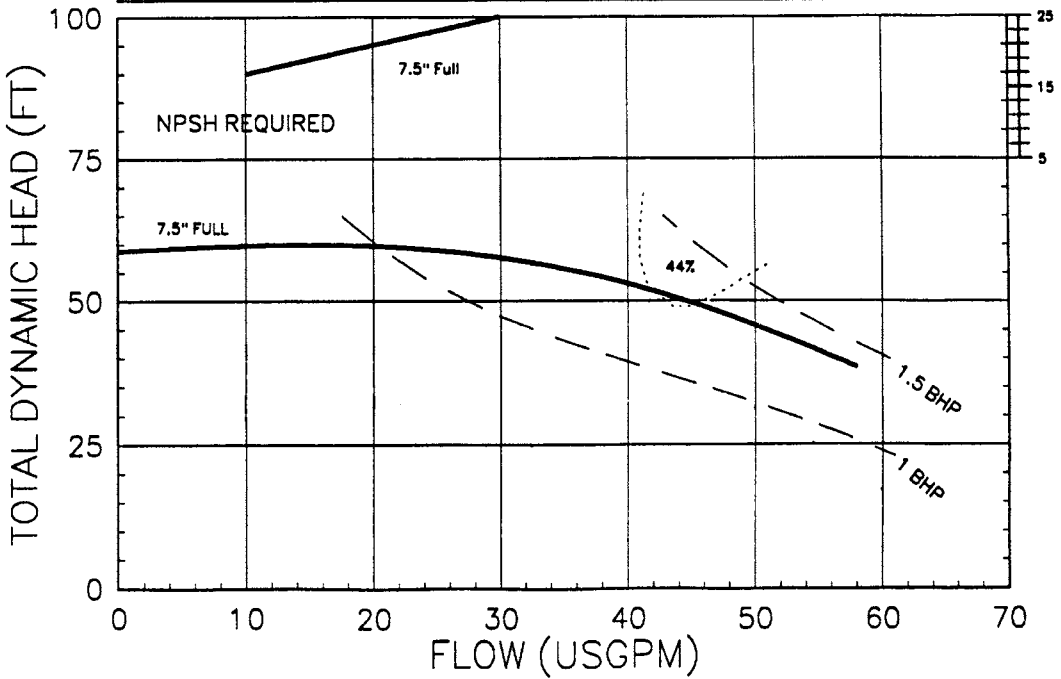

IRRIGATION & INDUSTRIAL

EP SERIES

EP (12K1)

Water Systems

Sump and Sewage

Lawn and Sprinkler

Electric Motor Driven

Engine Driven

Frame Mount

Hand Pumps

Irrigation and Industrial

COMPLETE PUMP & MOTOR ASSEMBLY							
	Model Number	Order Number	HP	Weight (lbs.)	Phase	RPM	Size
JM FRAME	EPE12K1H	657007	5	156	3	3450	1½ x 1¼
		657009	7½	211			
		657011	10	215			
EPE12K1H	EPE12K1H	657006	5	182	1	3450	1½ x 1¼
		657008	7½	228			
		657010	10	249			

	Model Number	Order Number	HP	Weight (lbs.)	Phase	RPM	Size
JP FRAME	EPE12K1H	657037	5	156	3	3450	1½ x 1¼
		657039	7½	211			
		657041	10	215			
EPE12K1H	EPE12K1H	657036	5	182	1	3450	1½ x 1¼
		657038	7½	228			
		657040	10	249			

	Model Number	Order Number	Weight (lbs.)	TR Frame	Max Imp. Dia. @ 3450 RPM	Max RPM	Size
TR	EPT12K1M	657303	141	1	7.5"	3450	1½ x 1¼
		657304	162	2	7.5"		
		657305	196	3	7.5"		

PUMP END - KIT COMPONENTS				
Casing	Impeller	Seal	Adapter	Frame Size
656011	656116	656626	656516	143JM-184JM
656011	656116	656626	656518	213JM-215JM
656011	656116	656626	656516	143JM-184JM
656011	656116	656626	656518	213JM-215JM

Casing	Impeller	Seal	Adapter	Frame Size
656011	656116	656621	656512	143JP-256JP
656011	656111	656622	656522	213JP-256JP
656011	656116	656621	656512	143JP-256JP
656011	656111	656622	656522	213JP-256JP

Casing	Impeller	Seal	Adapter	TR Frame
656011	656116	656621	656512	656711
656011	656111	656622	656522	656712
656011	656111	656622	656532	656713

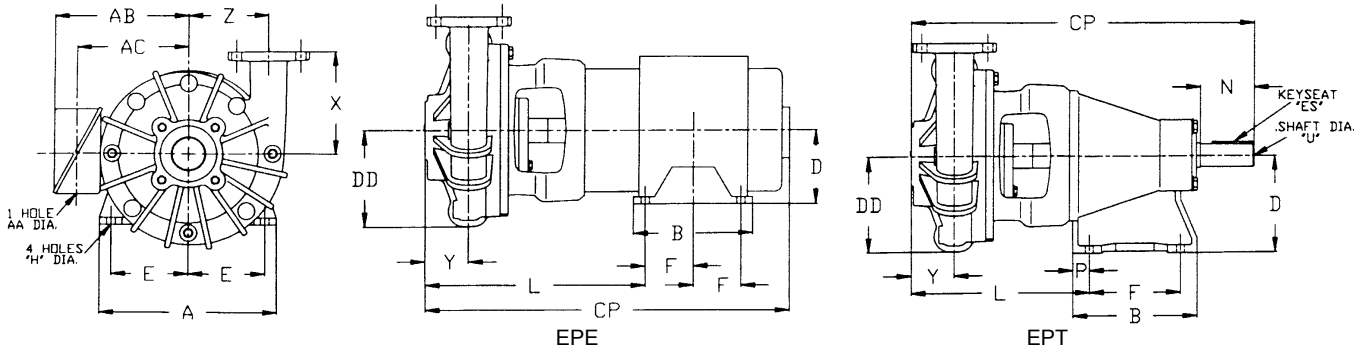

EPE12K1H 3600 RPM ODP - Dimensions measured in inches

Model	HP	Flange		A	AA	AB	AC	B	CP	D	DD	E	F	H	L	X	Y	Z
		Suct.	Disch.															
12K1H	5	1.5"	1.25"	9.00	¾	8.12	6.48	5.75	20.85	4.50	5.30	3.75	2.25	13/32	13.66	6.50	3.10	4.62
12K1H	7.5			9.00	¾	8.12	6.48	6.75	21.85	4.50		3.75	2.75	13/32	13.66			
12K1H	10			10.50	1	9.04	7.41	7.00	24.23	5.25		4.25	2.75	13/32	15.34			
12K1H	15			10.50	1	9.04	7.41	8.50	25.73	5.25		4.25	3.50	13/32	15.34			
12K1H	20			12.38	1 ¼	10.69	9.06	10.5	28.11	6.25		5.00	4.13	17/32	15.84			

EPT12K1 - DIMENSIONS MEASURED IN INCHES

Model	Flange		Trans.	A	B	CP	D	DD	E	ES	F	H	L	N	P	U	X	Y	Z
	Suct.	Disch.																	
12K1M	1.5"	1.25"	TR-1	6.50	8.00	21.22	5.50	5.30	2.50	¼	5.38	9/16	11.47	3.00	1.21	1.125	6.50	3.10	4.62
12K1H			TR-2	8.50	8.88	24.32	7.00		3.50	3/8	6.50	9/16	12.55	3.88	1.29	1.625			
12K1H			TR-3	9.50	9.38	25.72	8.00		4.00	½	7.00	11/16	12.55	5.00	1.31	2.125			

*Standard configurations include bronze impeller, single mechanical seal, and ODP motors. For a special shaft seal, motor or impeller option, please contact factory.

IRRIGATION & INDUSTRIAL EP SERIES

EP (12K1)

- Water Systems
- Sump and Sewage
- Lawn and Sprinkler
- Electric Motor Driven
- Engine Driven
- Frame Mount
- Hand Pumps

CURVE EPE12K1H	IMPELLER Various	Date	92/03/04	IMPELLER DIAMETERS	
		MWP (PSI)	250	10 HP: 7.2" Dia.	10+HP: 7.4" Dia.
SIZE 1.5" x 1.25"	SPEED 3525	Max. Solids	3/16"	7.5 HP: 6.4" Dia.	7.5+HP: 6.7" Dia.
				5 HP: 5.9" Dia.	5+HP: 6.1" Dia.

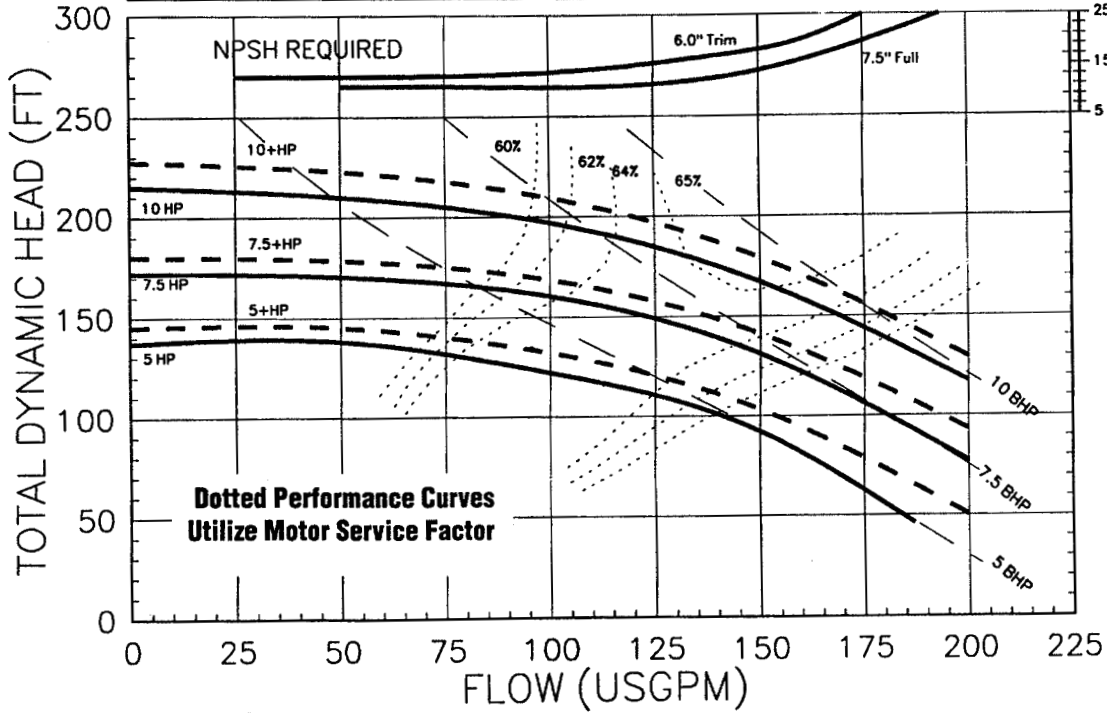

CURVE EPT12K1M	IMPELLER Various	Date	92/03/04	FRAME SELECTION
		MWP (PSI)	250	TR-1 UP TO 7.8" Diam.
SIZE 1.5" x 1.25"	SPEED 1750	Max. Solids	3/16"	

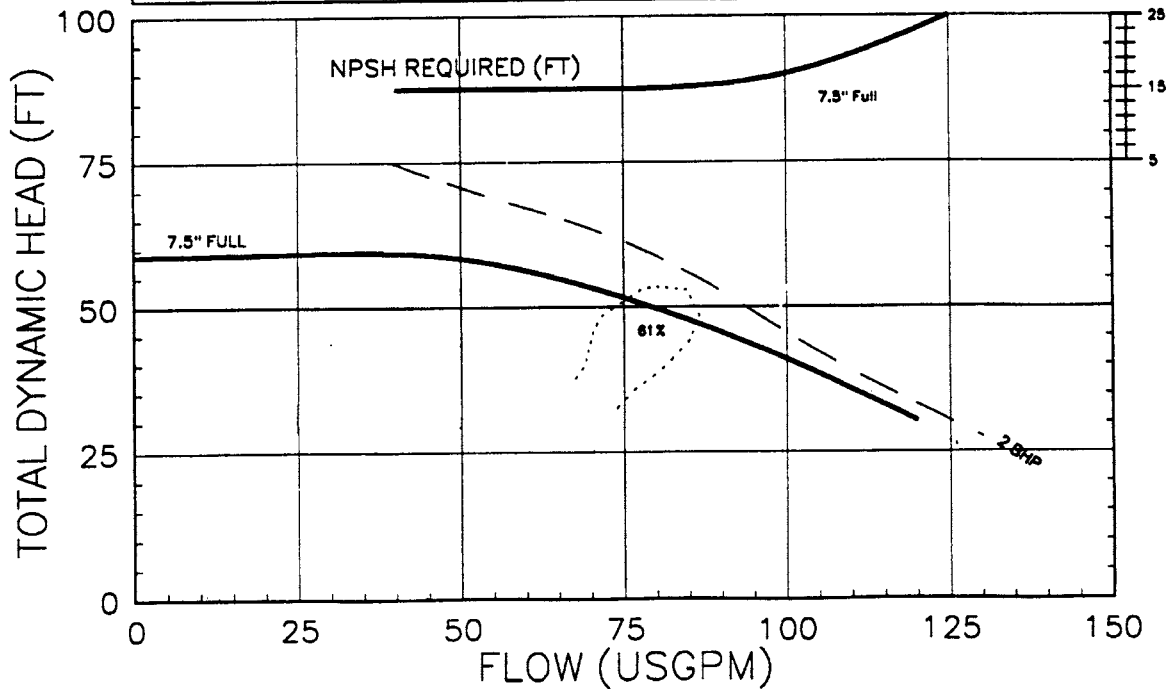

IRRIGATION & INDUSTRIAL EP SERIES

EP (20K2)

CURVE EPE20K2H	IMPELLER Various	Date	92/02/19	IMPELLER DIAMETERS	
		SIZE 3" x 2"	SPEED 3525	MWP (PSI)	250
		Max. Solids	3/8"		

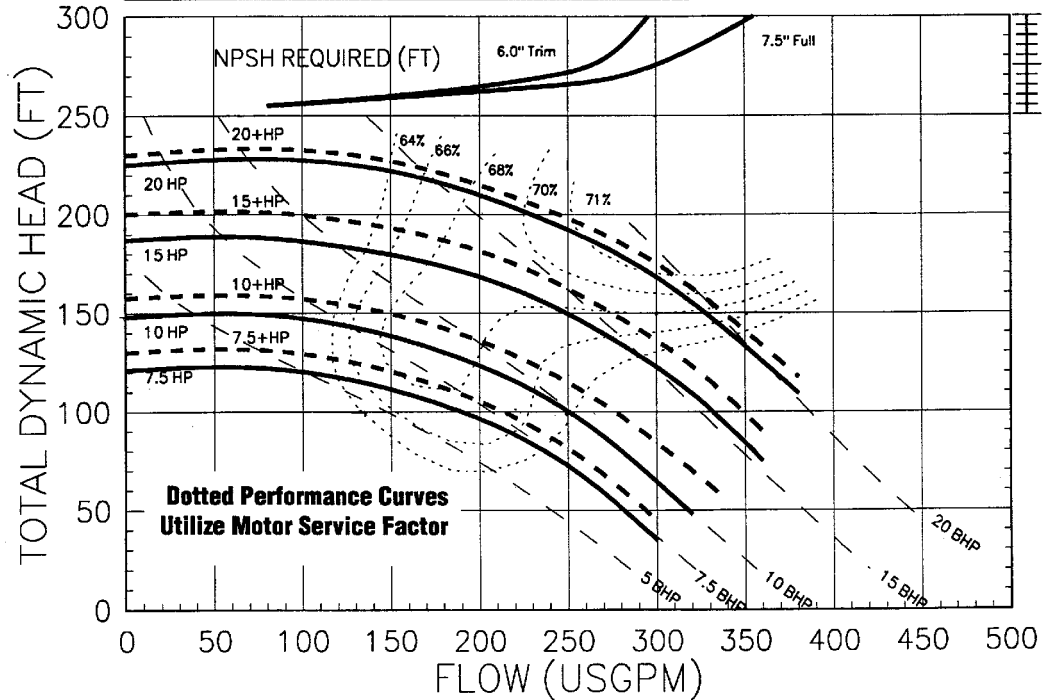

CURVE EPE20K2M	IMPELLER Various	Date	92/02/19	IMPELLER DIAMETERS	
		SIZE 3" x 2"	SPEED 1750	MWP (PSI)	250
		Max. Solids	3/8"		

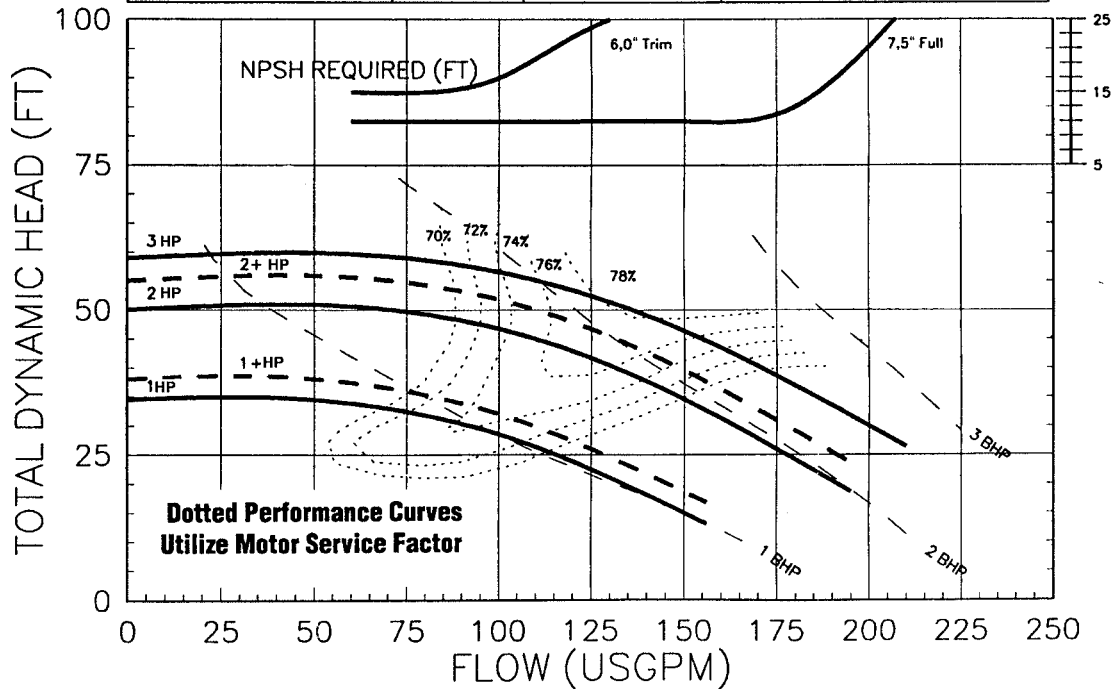

- Water Systems
- Sump and Sewage
- Lawn and Sprinkler
- Electric Motor Driven
- Engine Driven
- Frame Mount
- Hand Pumps

Irrigation and Industrial

IRRIGATION & INDUSTRIAL EP SERIES

EP (25K3)

Water Systems

Sump and Sewage

Lawn and Sprinkler

Electric Motor Driven

Engine Driven

Frame Mount

Hand Pumps

Irrigation and Industrial

COMPLETE PUMP & MOTOR ASSEMBLY							
	Model Number	Order Number	HP	Weight (lbs.)	Phase	RPM	Size
JM FRAME	EPE25K3H	657018	10	220	3	3450	3 x 2½
		657019	15	240			
	EPE25K3H	657017	10	254	1	3450	3 x 2½
		657107	1	142			
		657109	2	147			
	EPE25K3M	657111	3	167	3	1725	3 x 2½
		657106	1	152			
	EPE25K3M	657108	2	157	1	1725	3 x 2½
			3	185			
		657110	3	185			

	Model Number	Order Number	HP	Weight (lbs.)	Phase	RPM	Size
JP FRAME	EPE25K3H	657051	10	220	3	3450	3 x 2½
		657053	15	240			
		657055	20	350			
		657057	25*	355			
	EPE25K3H	657046	10	254	1	3450	3 x 2½
		657207	1	142			
		657209	2	147			
	EPE25K3M	657211	3	167	3	1725	3 x 2½
			657206	1			
		EPE25K3M	657208	2	157	1	1725
	657210		3	185			

	Model Number	Order Number	Weight (lbs.)	TR Frame	Max Imp. Dia. @ 3450 RPM	Max RPM	Size
TR	EPT25K3M	657309	146	1	7.5"	3450	3 x 2½
	EPT25K3H	657310	167	2	7.5"		
		657311	197	3	7.5"		

PUMP END - KIT COMPONENTS				
Casing	Impeller	Seal	Adapter	Frame Size
656013	656136	656626	656518	213JM-215JM
656013	656136	656626	656518	213JM-215JM
656013	656136	656626	656516	143JM-184JM
656013	656136	656626	656516	143JM-184JM

Casing	Impeller	Seal	Adapter	Frame Size
656013	656131	656622	656522	213JP-256JP
656013	656131	656622	656522	213JP-256JP
656013	656136	656621	656512	143JP-184JP
656013	656136	656621	656512	143JP-184JP

Casing	Impeller	Seal	Adapter	TR Frame
656013	656136	656621	656512	656711
656013	656131	656622	656522	656712
656013	656131	656622	656532	656713

*25 HP TEFC configuration uses group 3 power frame (284JP-326JP).

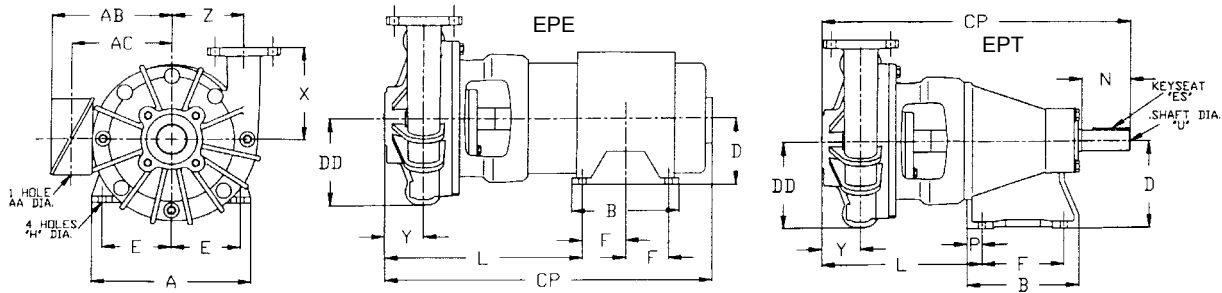

EPE25K3H 3600 RPM ODP - DIMENSIONS MEASURED IN INCHES																		
Model	HP	Flange		A	AA	AB	AC	B	CP	D	DD	E	F	H	L	X	Y	Z
		Suct.	Disch.															
25K3H	10	3"	2.5"	10.50	1	9.04	7.41	7.00	24.95	5.25	5.80	4.25	2.75	13/32	16.06	7.50	3.65	4.94
	15			12.38	1	9.04	7.41	8.50	26.45	5.25		4.25	3.50	13/32	16.06			
	20			12.38	1 ¼	10.69	9.06	10.50	28.83	6.25		5.00	4.13	17/32	16.56			
	25			12.38	1 ¼	10.69	9.06	12.25	30.57	6.25		5.00	5.00	17/32	16.56			
	30			13.88	1 ½	12.62	10.7	12.25	30.57	7.00		5.50	4.75	17/32	16.56			

EPT25K3 - DIMENSIONS MEASURED IN INCHES																			
Model	Flange		Trans.	A	B	CP	D	DD	E	ES	F	H	L	N	P	U	X	Y	Z
	Suct.	Disch.																	
25K3M	3"	2.5"	TR-1	6.50	8.00	21.94	5.50	5.80	2.50	¼	5.38	9/16	12.19	3.00	1.21	1.125	7.50	3.65	4.94
25K3H			TR-2	8.50	8.88	24.04	7.00		3.50	3/8	6.50	9/16	13.27	3.88	1.29	1.625			
25K3H			TR-3	9.50	9.38	26.45	8.00		4.00	½	7.00	11/16	13.27	5.00	1.31	2.125			

*Standard configurations include bronze impeller, single mechanical seal, and ODP motors. For a special shaft seal, motor or impeller option, please contact factory.

IRRIGATION & INDUSTRIAL

EP SERIES

EP (25K3)

- Water Systems
- Sump and Sewage
- Lawn and Sprinkler
- Electric Motor Driven
- Engine Driven
- Frame Mount
- Hand Pumps

Irrigation and Industrial

CURVE EPE25K3H	IMPELLER Various	Date 92/02/18	IMPELLER DIAMETERS	
	SPEED 3525	MWP (PSI) 250	25 HP : 7,3" Dia.	25+HP: 7,5" Dia.
SIZE 3" x 2,5"		Max. Solids 7/16_{po}	20 HP : 6,7" Dia.	20+HP: 7,0" Dia.
			15 HP : 6,2" Dia.	15+HP: 6,5" Dia.
			10 HP : 5,4" Dia.	10+HP: 5,7" Dia.

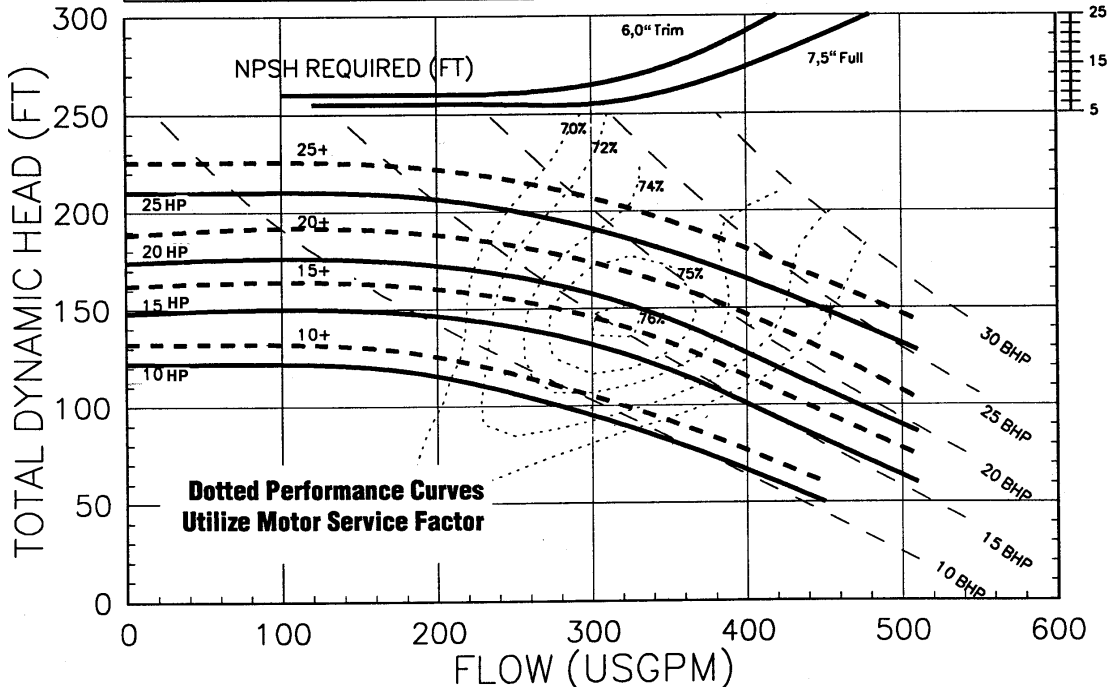

CURVE EPE25K3M	IMPELLER Various	Date 92/02/18	IMPELLER DIAMETERS	
	SPEED 1750	MWP (PSI) 250	3 HP: 7,2" Dia.	3+HP: 7,3" Dia.
SIZE 3" x 2,5"		Max. Solids 7/16"	2 HP: 6,4" Dia.	2+HP: 6,6" Dia.
			1 HP: 5,0" Dia.	1+HP: 5,3" Dia.

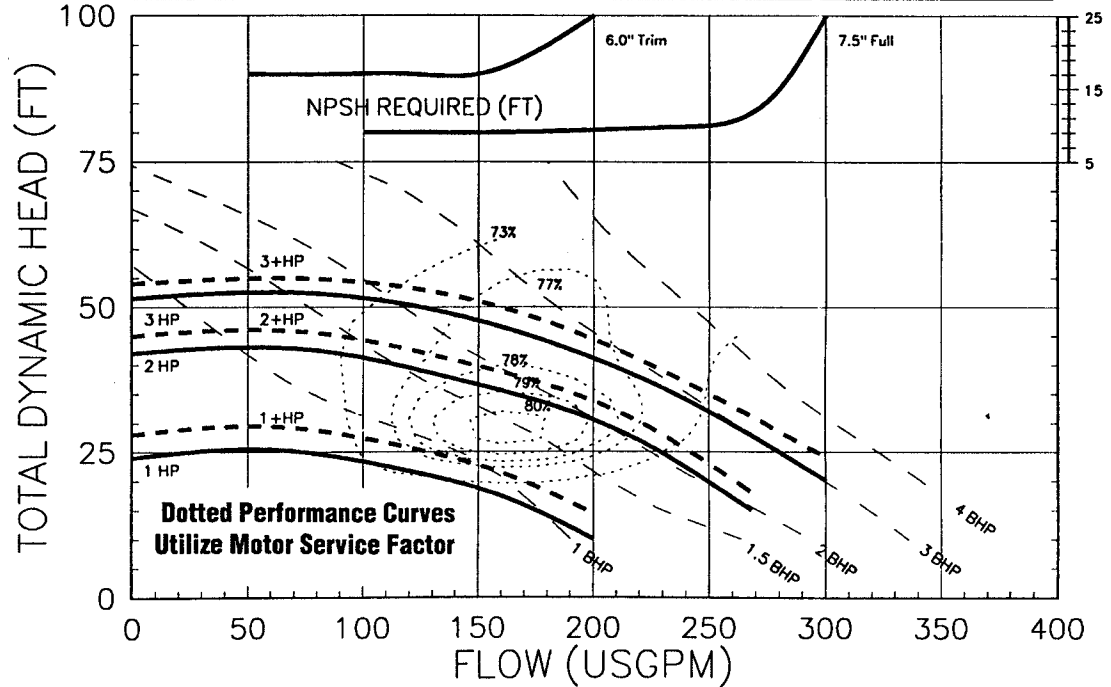

IRRIGATION & INDUSTRIAL

EP SERIES

EP (30K4)

Water Systems

Sump and Sewage

Lawn and Sprinkler

Electric Motor Driven

Engine Driven

Frame Mount

Hand Pumps

Irrigation and Industrial

COMPLETE PUMP & MOTOR ASSEMBLY

	Model Number	Order Number	HP	Weight (lbs.)	Phase	RPM	Size
JM FRAME	EPE30K4H	657020	15	246	3	3450	4 x 3
		657113	2	150			
	EPE30K4M	657115	3	170	3	1725	4 x 3
		657117	5	180			
	EPE30K4M	657112	2	160	1	1725	4 x 3
			3	188			
5			205				

	Model Number	Order Number	HP	Weight (lbs.)	Phase	RPM	Size
JP FRAME	EPE30K4H	657059	15	246	3	3450	4 x 3
		657061	20	356			
		657063	25*	361			
		657065	30	438			
	EPE30K4M	657213	2	150	3	1725	4 x 3
			3	170			
			5	180			
	EPE30K4M	657212	2	160	1	1725	4 x 3
			3	188			
			5	205			

	Model Number	Order Number	Weight (lbs.)	TR Frame	Max Imp. Dia. @ 3450 RPM	Max RPM	Size
TR	EPT30K4M	657312	152	1	6.5"	3200	4 x 3
	EPT30K4H	657313	173	2	7.5"	3450	
		657314	207	3	7.5"		

*25 HP TEFC configuration uses group 3 power frame (284JP-326JP).

PUMP END - KIT COMPONENTS

Casing	Impeller	Seal	Adapter	Frame Size
656014	656146	656626	656518	213JM-215JM
656014	656146	656626	656516	143JM-184JM
656014	656146	656626	656516	143JM-184JM
656014	656146	656626	656518	213JM-215JM

Casing	Impeller	Seal	Adapter	Frame Size
656014	656141	656622	656522	213JP-256JP
656014	656141	656622	656532	284JP-326JP
656014	656146	656621	656512	143JP-184JP
656014	656146	656621	656512	143JP-184JP
656014	656141	656622	656522	213JP-256JP

Casing	Impeller	Seal	Adapter	TR Frame
656014	656146	656621	656512	656711
656014	656141	656622	656522	656712
656014	656141	656622	656532	656713

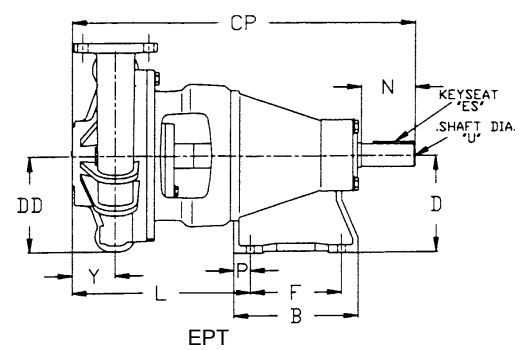
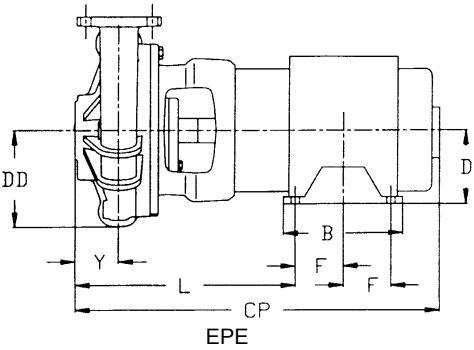
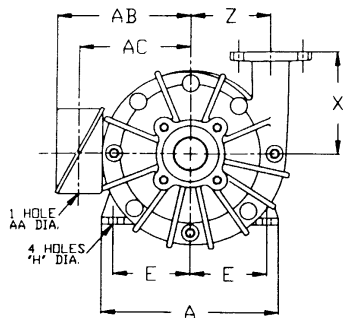

EPE30K4H 3600 RPM ODP - DIMENSIONS MEASURED IN INCHES

Model	HP	Flange		A	AA	AB	AC	B	CP	D	DD	E	F	H	L	X	Y	Z
		Suct.	Disch.															
30K4H	15	4"	3"	10.50	1	9.04	7.41	8.50	26.45	5.25	6.1	4.25	3.50	13/32	16.06	7.50	3.60	5.12
	20			12.38	1 1/4	10.69	9.06	10.5	28.83	6.25		5.00	4.13	17/32	16.56			
	25			12.38	1 1/4	10.69	9.06	12.25	30.57	6.25		5.00	5.00	17/32	16.56			
	30			13.88	1 1/2	12.62	10.70	12.25	30.57	7.00		5.50	4.75	17/32	16.56			
	40			13.88	1 1/2	12.62	10.70	13.75	32.07	7.00		5.50	5.50	17/32	16.56			

EPT30K4 - DIMENSIONS MEASURED IN INCHES

Model	Flange		Trans.	A	B	CP	D	DD	E	ES	F	H	L	N	P	U	X	Y	Z
	Suct.	Disch.																	
30K4M	4"	3"	TR-1	6.50	8.00	21.94	5.50	6.10	2.50	1/4	5.38	9/16	12.19	3.00	1.21	1.125	7.50	3.60	5.12
30K4H			TR-2	8.50	8.88	25.04	7.00		3.50	3/8	6.50	9/16	13.27	3.88	1.29	1.625			
30K4H			TR-3	9.50	9.38	26.45	8.00		4.00	1/2	7.00	11/16	13.27	5.00	1.31	2.125			

*Standard configurations include bronze impeller, single mechanical seal, and ODP motors. For a special shaft seal, motor or impeller option, please contact factory.

IRRIGATION & INDUSTRIAL EP SERIES

EP (30K4)

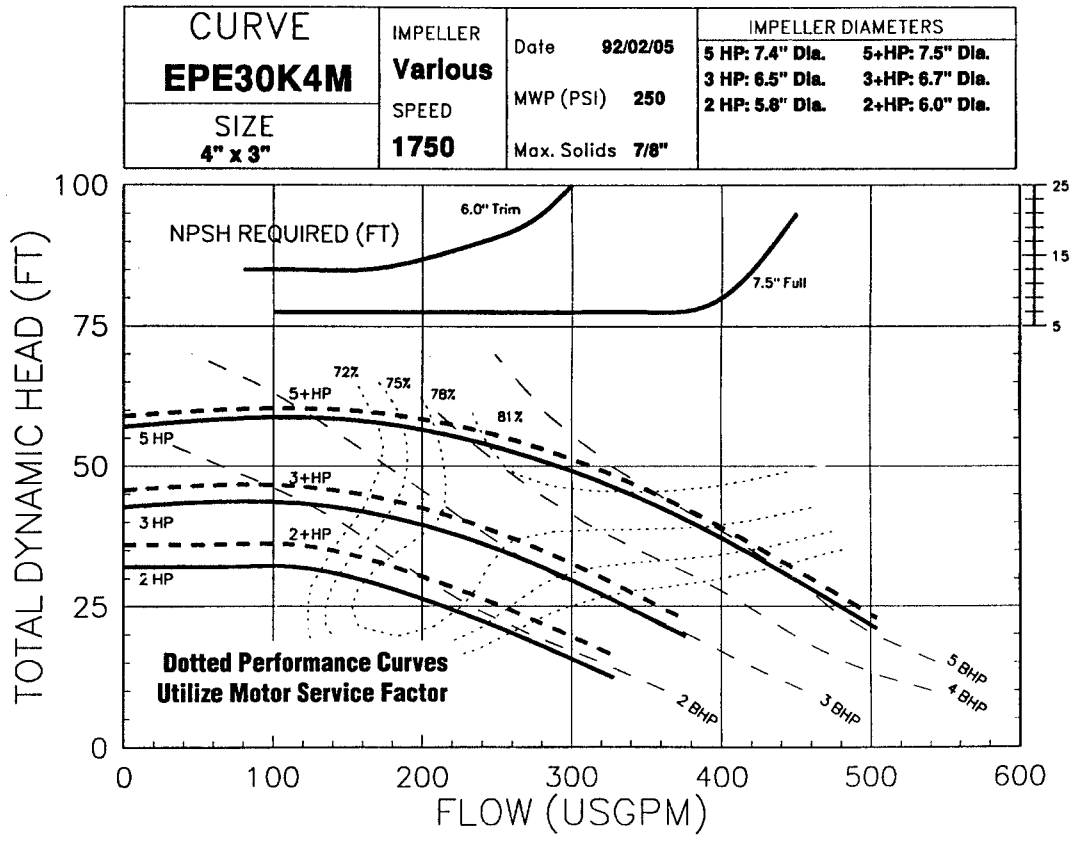
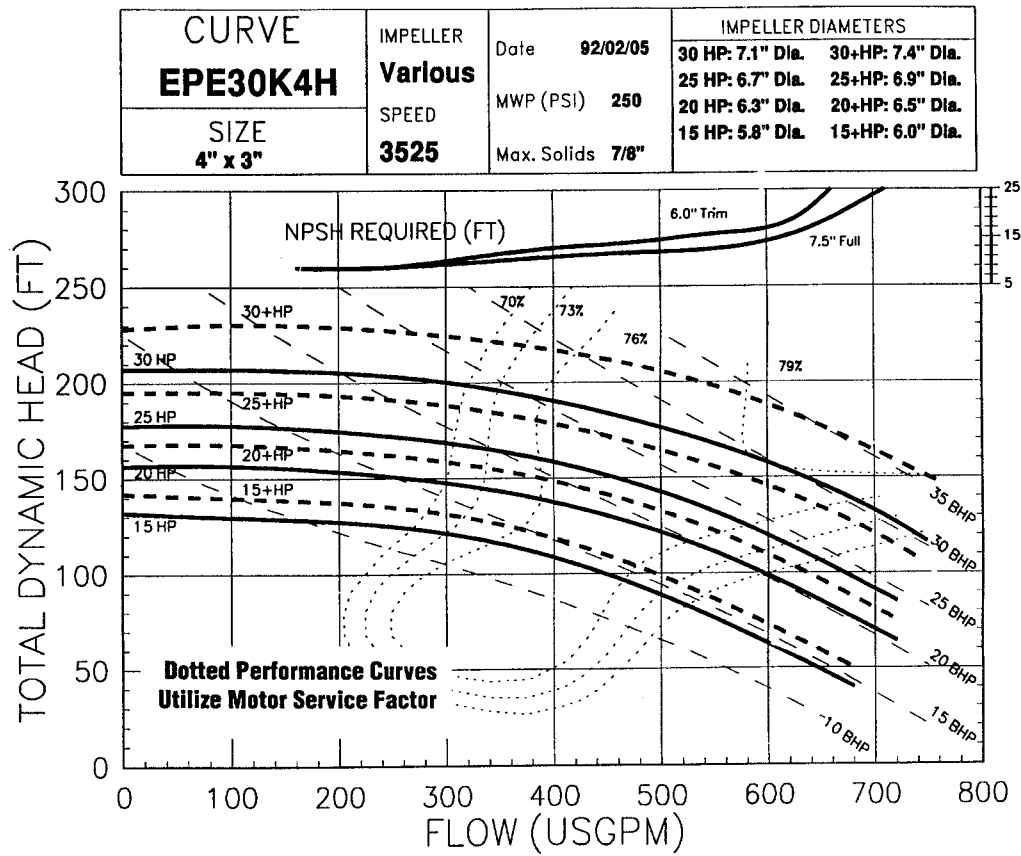

- Water Systems
- Sump and Sewage
- Lawn and Sprinkler
- Electric Motor Driven
- Engine Driven
- Frame Mount
- Hand Pumps

Irrigation and Industrial

IRRIGATION & INDUSTRIAL EP SERIES

EP (12M1)

Water Systems

Sump and Sewage

Lawn and Sprinkler

Electric Motor Driven

Engine Driven

Frame Mount

Hand Pumps

Irrigation and Industrial

COMPLETE PUMP & MOTOR ASSEMBLY						
Model Number	Order Number	HP	Weight (lbs.)	Phase	RPM	Size
EPE12M1H	657022	7½	190	3	3450	2 x 1¼
	657024	10	235			
	657025	15	245			
EPE12M1H	657021	7½	245	1	3450	2 x 1¼
	657023	10	265			
EPE12M1M	657119	1	160	3	1725	2 x 1¼
	657121	2	165			
	657123	3	185			
EPE12M1M	657118	1	180	1	1725	2 x 1¼
	657120	2	185			
	657122	3	200			

PUMP END - KIT COMPONENTS				
Casing	Impeller	Seal	Adapter	Frame Size
656021	656216	656626	656517	143JM-184JM
656021	656216	656626	656519	213JM-215JM
656021	656216	656626	656519	213JM-215JM
656021	656216	656626	656517	143JM-184JM
656021	656216	656626	656517	143JM-184JM

Model Number	Order Number	HP	Weight (lbs.)	Phase	RPM	Size
EPE12M1H	657067	7½	190	3	3450	2 x 1¼
	657069	10	235			
	657071	15	245			
	657073	20	355			
EPE12M1H	657048	7½	245	1	3450	2 x 1¼
	657050	10	265			
EPE12M1M	657219	1	160	3	1725	2 x 1¼
	657221	2	165			
	657223	3	185			
EPE12M1M	657218	1	180	1	1725	2 x 1¼
	657220	2	185			
	657222	3	200			

Casing	Impeller	Seal	Adapter	Frame Size
656021	656216	656621	656513	143JP-184JP
656021	656211	656622	656523	213JP-256JP
656021	656211	656622	656523	213JP-256JP
656021	656216	656621	656513	143JP-184JP
656021	656216	656621	656513	143JP-184JP

Model Number	Order Number	Weight (lbs.)	TR Frame	Max Imp. Dia. @ 3450 RPM	Max RPM	Size
EPT12M1M	657315	166	1	8.5"	3000	2 x 1¼
EPT12M1H	657316	185	2	9.5"	3450	
EPT12M1H	657317	215	3	9.5"		

Casing	Impeller	Seal	Adapter	TR Frame
656021	656216	656621	656513	656711
656021	656211	656622	656523	656712
656021	656211	656622	656533	656713

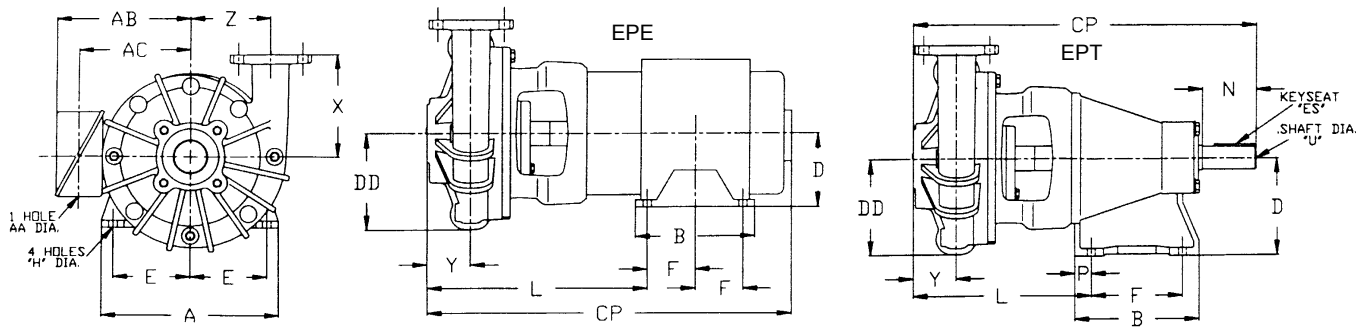

EPE12M1H 3600 RPM ODP - DIMENSIONS MEASURED IN INCHES																		
Model	HP	Flange		A	AA	AB	AC	B	CP	D	DD	E	F	H	L	X	Y	Z
		Suct.	Disch.															
12M1H	7.5	2"	1.25"	9	¾	8.12	6.48	6.75	21.85	4.50	6.14	3.75	2.75	13/32	13.66	7.50	2.81	5.25
	10			10.5	1	9.04	7.41	7.00	24.22	5.25	6.14	4.25	2.75	13/32	15.34	7.50	2.81	5.25
	15			10.5	1	9.04	7.41	8.50	25.72	5.25	6.14	4.25	3.50	13/32	15.34	7.50	2.81	5.25
	20			12.38	1 ¼	10.69	9.06	10.50	28.10	6.25	6.14	5.00	4.13	17/32	15.84	7.50	2.81	5.25

EPT12M1 - DIMENSIONS MEASURED IN INCHES																			
Model	Flange		Trans.	A	B	CP	D	DD	E	ES	F	H	L	N	P	U	X	Y	Z
	Suct.	Disch.																	
12M1H	2"	1.25"	TR-2	8.50	8.88	24.32	7.00	6.14	3.50	3/8	6.50	9/16	12.54	3.88	1.29	1.625	7.50	2.81	5.25
12M1H			TR-3	9.50	9.38	25.72	8.00	6.14	4.00	½	7.00	11/16	12.54	4.99	1.31	2.125	7.50	2.81	5.25

*Standard configurations include bronze impeller, single mechanical seal, and ODP motors. For a special shaft seal, motor or impeller option, please contact factory.

IRRIGATION & INDUSTRIAL EP SERIES

EP (12M1)

CURVE EPE12M1H	IMPELLER Various	Date	91/08/14	IMPELLER DIAMETERS	
		MWP (PSI)	250	20 HP: 9.3" Dia.	20+HP: 9.5" Dia.
SIZE 2" x 1.25"	SPEED 3525	Max. Solids	1/4"	15 HP: 8.5" Dia.	15+HP: 8.8" Dia.
				10 HP: 7.7" Dia.	10+HP: 7.9" Dia.
				7.5 HP: 7.1" Dia.	7.5+HP: 7.2" Dia.

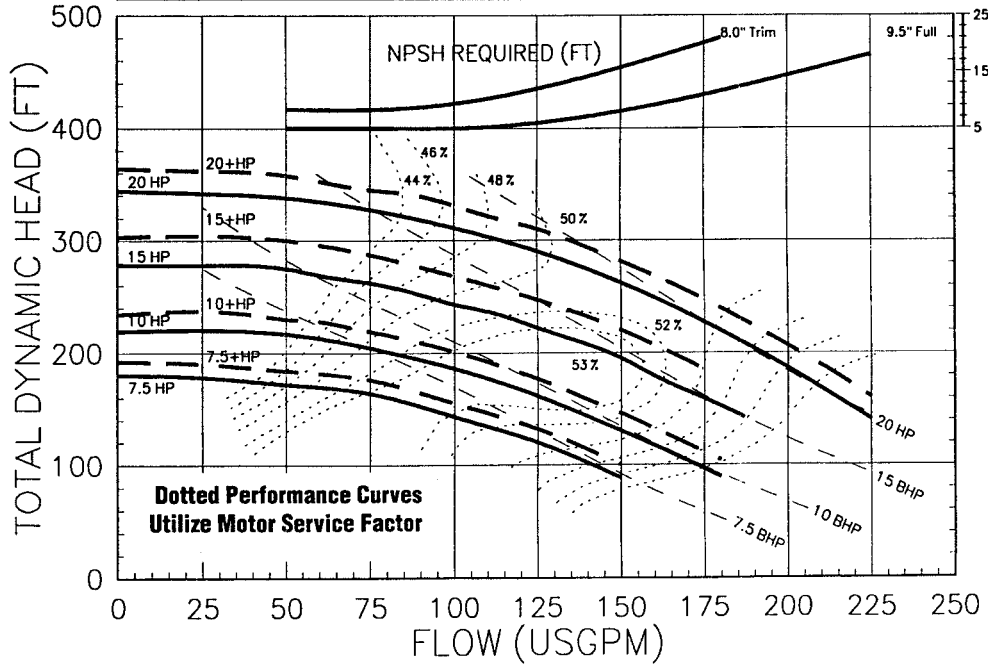

CURVE EPE12M1M	IMPELLER Various	Date	91/08/14	IMPELLER DIAMETERS	
		MWP (PSI)	250	3 HP: 9.5" Dia.	2+HP: 9.3" Dia.
SIZE 2" x 1.25"	SPEED 1750	Max. Solids	1/4"	2 HP: 9.0" Dia.	2+HP: 9.3" Dia.
				1 HP: 7.8" Dia.	1+HP: 8.0" Dia.

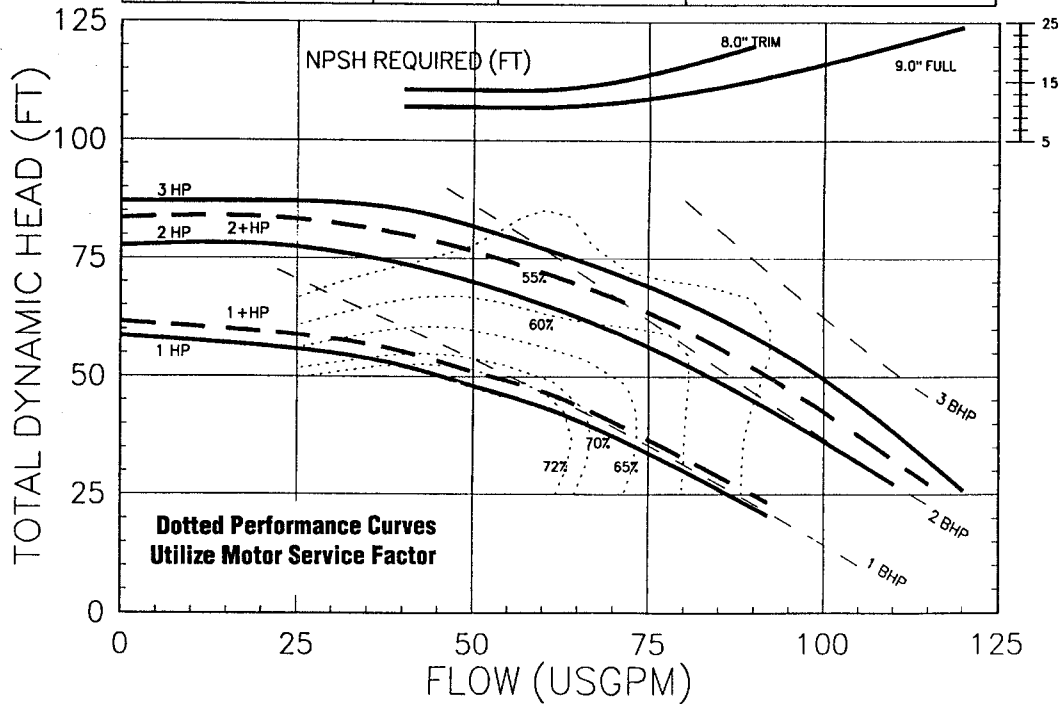

- Water Systems
- Sump and Sewage
- Lawn and Sprinkler
- Electric Motor Driven
- Engine Driven
- Frame Mount
- Hand Pumps

Irrigation and Industrial

IRRIGATION & INDUSTRIAL EP SERIES

EP (15M2)

Water Systems

Sump and Sewage

Lawn and Sprinkler

Electric Motor Driven

Engine Driven

Frame Mount

Hand Pumps

Irrigation and Industrial

COMPLETE PUMP & MOTOR ASSEMBLY							
	Model Number	Order Number	HP	Weight (lbs.)	Phase	RPM	Size
JM FRAME	EPE15M2M	657125	2	190	3	1725	2 x 1½
		657127	3	205			
		657129	5	245			
	EPE15M2M	657124	2	190	1	1725	2 x 1½
		657126	3	205			
		657128	5	250			

	Model Number	Order Number	HP	Weight (lbs.)	Phase	RPM	Size
JP FRAME	EPE15M2H	657075	20	360	3	3450	2 x 1½
		657077	25*	365			
		657079	30	440			
		657081	40	500			
	EPE15M2M	657225	2	190	3	1725	2 x 1½
		657227	3	205			
		657229	5	245			
	EPE15M2M	657224	2	190	1	1725	2 x 1½
		657226	3	205			
		657228	5	250			

	Model Number	Order Number	Weight (lbs.)	TR Frame	Max Imp. Dia. @ 3450 RPM	Max RPM	Size
TR	EPT15M2M	657318	171	1	8.0"	2600	2 x 1½
	EPT15M2H	657319	190	2	8.5"	3000	
		657320	220	3	9.5"	3450	

*25 HP TEFC configuration uses group 3 power frame (284JP-326JP).

PUMP END - KIT COMPONENTS				
Casing	Impeller	Seal	Adapter	Frame Size
656022	656226	656626	656517	143JM-184JM
656022	656226	656626	656517	143JM-184JM
656022	656226	656626	656519	213JM-215JM

Casing	Impeller	Seal	Adapter	Frame Size
656022	656221	656622	656523	213JP-256JP
656022	656221	656622	656533	284JP-326JP
656022	656226	656621	656513	143JP-184JP
656022	656226	656621	656513	143JP-184JP
656022	656221	656622	656523	213JP-256JP

Casing	Impeller	Seal	Adapter	TR Frame
656022	656226	656621	656513	656711
656022	656221	656622	656523	656712
656022	656221	656622	656533	656713

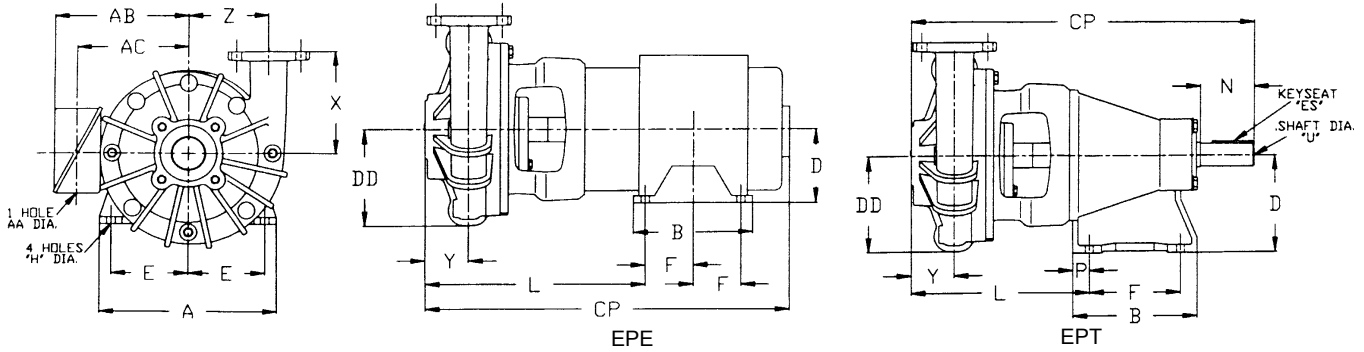

EPE15M2H 3600 RPM ODP - DIMENSIONS MEASURED IN INCHES																		
Model	HP	Flange		A	AA	AB	AC	B	CP	D	DD	E	F	H	L	X	Y	Z
		Suct.	Disch.															
15M2H	20	2"	1.5"	12.38	1 ¼	10.69	9.06	10.50	28.07	6.25	6.13	5.00	4.13	17/32	15.81	7.50	2.81	5.69
	25			12.38	1 ¼	10.69	9.06	12.25	29.81	6.25	6.13	5.00	5.00	17/32	15.81	7.50	2.81	5.69
	30			13.88	1 ½	12.62	10.70	12.25	29.81	7.00	6.13	5.5	4.75	17/32	15.81	7.50	2.81	5.69
	40			13.88	1 ½	12.62	10.70	13.75	31.31	7.00	6.13	5.5	5.50	17/32	15.81	7.50	2.81	5.69

EPT15M2 - DIMENSIONS MEASURED IN INCHES																			
Model	Flange		Trans.	A	B	CP	D	DD	E	ES	F	H	L	N	P	U	X	Y	Z
	Suct.	Disch.																	
15M2H	2"	1.5"	TR-2	8.50	8.88	24.29	7.00	6.13	3.50	3/8	6.50	9/16	12.51	3.88	1.29	1.625	7.50	2.81	5.69
15M2H			TR-3	9.50	9.38	25.69	8.00	6.13	4.00	½	7.00	11/16	12.51	4.99	1.31	2.125	7.50	2.81	5.69

*Standard configurations include bronze impeller, single mechanical seal, and ODP motors. For a special shaft seal, motor or impeller option, please contact factory.

IRRIGATION & INDUSTRIAL EP SERIES

EP (15M2)

CURVE EPE15M2H	IMPELLER Various	Date 91/08/04	IMPELLER DIAMETERS	
	SPEED 3525	MWP (PSI) 250	40 HP: 9.5" Dia.	30+HP: 9.3" Dia.
SIZE 2" x 1.5"		Max. Solids 1/4"	25 HP: 8.3" Dia.	25+HP: 8.5" Dia.
			20 HP: 7.8" Dia.	20+HP: 8.0" Dia.

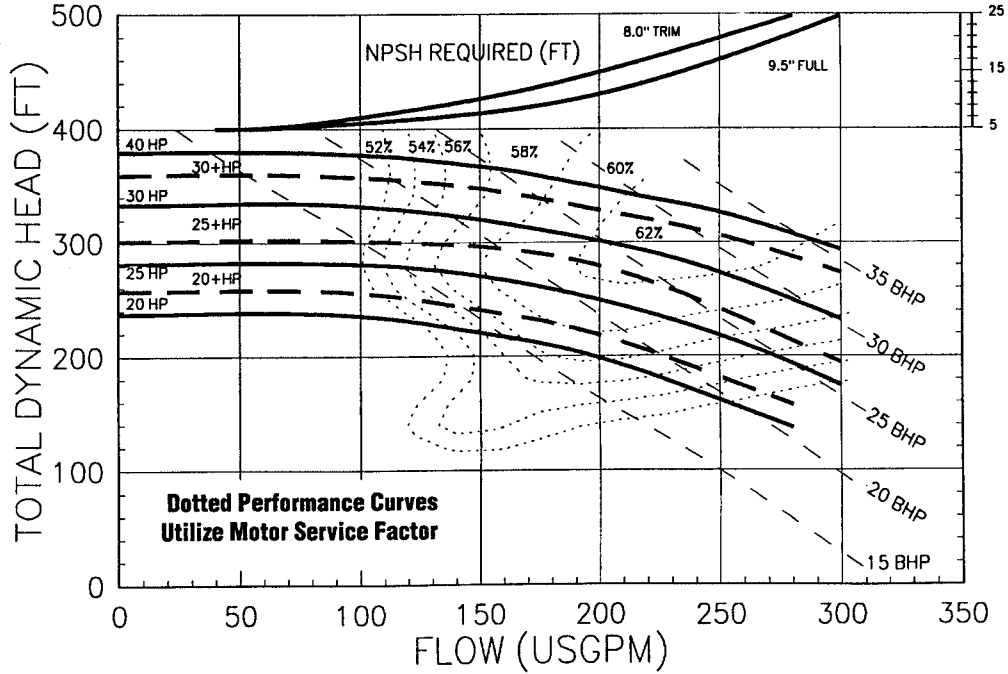

CURVE EPE15M2M	IMPELLER Various	Date 91/09/04	IMPELLER DIAMETERS	
	SPEED 1750	MWP (PSI) 250	5 HP: 9.5" Dia.	3+HP: 8.5" Dia.
SIZE 2" x 1.5"		Max. Solids 1/4"	3 HP: 8.2" Dia.	2+HP: 7.4" Dia.
			2 HP: 7.2" Dia.	2+HP: 7.4" Dia.

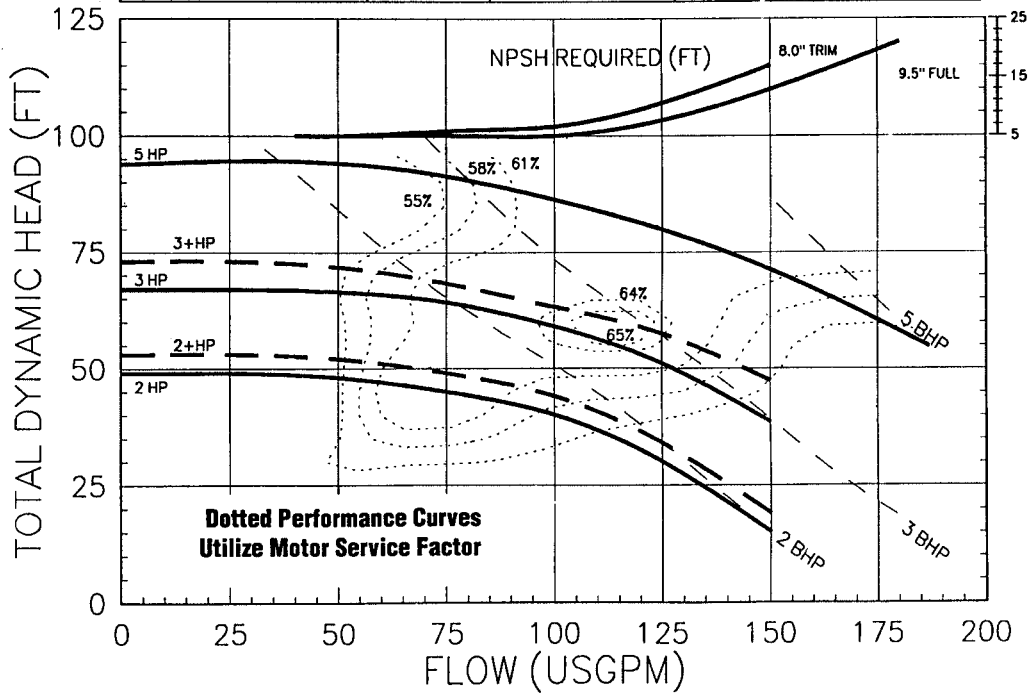

- Water Systems
- Sump and Sewage
- Lawn and Sprinkler
- Electric Motor Driven
- Engine Driven
- Frame Mount
- Hand Pumps

Irrigation and Industrial

IRRIGATION & INDUSTRIAL EP SERIES

EP (20M3)

Water Systems
Sump and Sewage

Lawn and Sprinkler

Electric Motor Driven

Engine Driven

Frame Mount

Hand Pumps

Irrigation and Industrial

COMPLETE PUMP & MOTOR ASSEMBLY							
	Model Number	Order Number	HP	Weight (lbs.)	Phase	RPM	Size
JM FRAME	EPE20M3M	657131	3	190	3	1725	2½ x 2
		657133	5	235			
		657135	7½	245			
	EPE20M3M	657130	3	210	1	1725	2½ x 2
		657132	5	255			
		657134	7½	245			

	Model Number	Order Number	HP	Weight (lbs.)	Phase	RPM	Size
JP FRAME	EPE20M3H	657083	20	365	3	3450	2½ x 2
		657085	25*	370			
		657087	30	445			
		657089	40	505			
	EPE20M3M	657231	3	190	3	1725	2½ x 2
		657233	5	235			
		657235	7½	245			
	EPE20M3M	657230	3	210	1	1725	2½ x 2
		657232	5	255			
		657234	7½	245			

	Model Number	Order Number	Weight (lbs.)	TR Frame	Max Imp. Dia. @ 3450 RPM	Max RPM	Size
TR	EPT20M3M	657321	174	1		2600	2½ x 2
	EPT20M3H	657322	195	2	8.5"	3000	
		657323	225	3	9.5"	3450	

*25 HP TEFC configuration uses group 3 power frame (284JP-326JP).

PUMP END - KIT COMPONENTS				
Casing	Impeller	Seal	Adapter	Frame Size
656023	656236	656626	656517	143JM-184JM
656023	656236	656626	656519	213JM-215JM
656023	656236	656626	656517	143JM-184JM
656023	656236	656626	656519	213JM-215JM

Casing	Impeller	Seal	Adapter	Frame Size
656023	656231	656622	656523	213JP-256JP
656023	656231	656622	656533	284JP-326JP
656023	656236	656621	656513	143JP-184JP
656023	656231	656622	656523	213JP-256JP
656023	656236	656621	656513	143JP-184JP
656023	656231	656622	656523	213JP-256JP

Casing	Impeller	Seal	Adapter	TR Frame
656023	656236	656621	656513	656711
656023	656231	656622	656523	656712
656023	656231	656622	656533	656713

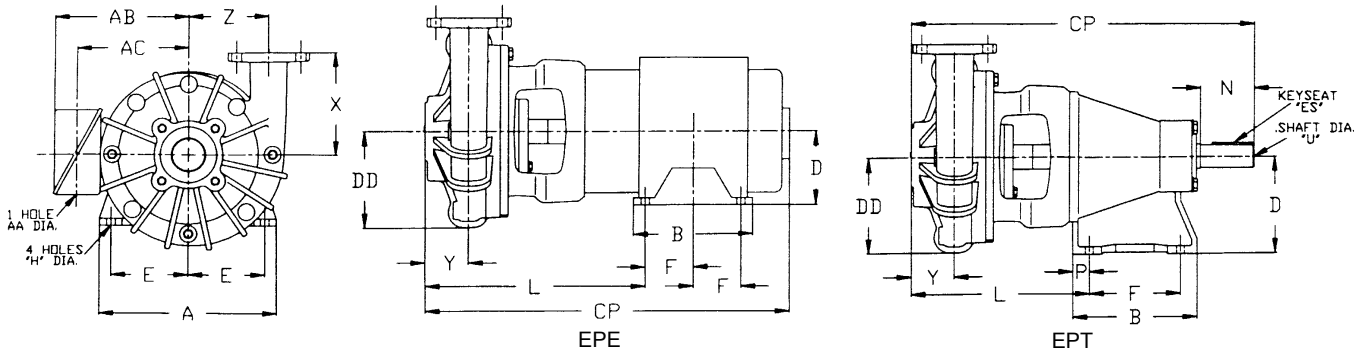

EPE20M3H 3600 RPM ODP - DIMENSIONS MEASURED IN INCHES																		
Model	HP	Flange		A	AA	AB	AC	B	CP	D	DD	E	F	H	L	X	Y	Z
		Suct.	Disch.															
20M3H	20	2.5"	2"	12.38	1 ¼	10.69	9.06	10.5	28.39	6.25	6.43	5.00	4.13	17/32	16.13	7.50	3.10	5.88
	25			12.38	1 ¼	10.69	9.06	12.25	30.13	6.25	6.43	5.00	5.00	17/32	16.13	7.50	3.10	5.88
	30			13.88	1 ½	12.62	10.70	12.25	30.13	7.00	6.43	5.50	4.75	17/32	16.13	7.50	3.10	5.88
	40			13.88	1 ½	12.62	10.70	13.75	31.63	7.00	6.43	5.50	5.50	17/32	16.13	7.50	3.10	5.88

EPT20M3 - DIMENSIONS MEASURED IN INCHES																			
Model	Flange		Trans.	A	B	CP	D	DD	E	ES	F	H	L	N	P	U	X	Y	Z
	Suct.	Disch.																	
20M3H	2.5"	2"	TR-2	8.50	8.88	24.61	7.00	6.43	3.50	3/8	6.50	9/16	12.83	3.88	1.29	1.625	7.50	3.10	5.88
20M3H			TR-3	9.50	9.38	26.01	8.00	6.43	4.00	½	7.00	11/16	12.83	4.99	1.31	2.125	7.50	3.10	5.88

*Standard configurations include bronze impeller, single mechanical seal, and ODP motors. For a special shaft seal, motor or impeller option, please contact factory.

IRRIGATION & INDUSTRIAL

EP SERIES

EP (20M3)

Water Systems

Sump and Sewage

Lawn and Sprinkler

Electric Motor Driven

Engine Driven

Frame Mount

Hand Pumps

Irrigation and Industrial

CURVE EPE20M3H	IMPELLER Various	Date	91/08/16		
		MWP (PSI)	250		
SIZE 2.5" x 2"	SPEED 3525	Max. Solids	5/16"		
		IMPELLER DIAMETERS			
		40 HP: 9.2" Dia.	40+HP: 9.5" Dia.		
		30 HP: 8.0" Dia.	30+HP: 8.3" Dia.		
		25 HP: 7.5" Dia.	25+HP: 7.8" Dia.		
		20 HP: 7.0" Dia.	20+HP: 7.2" Dia.		

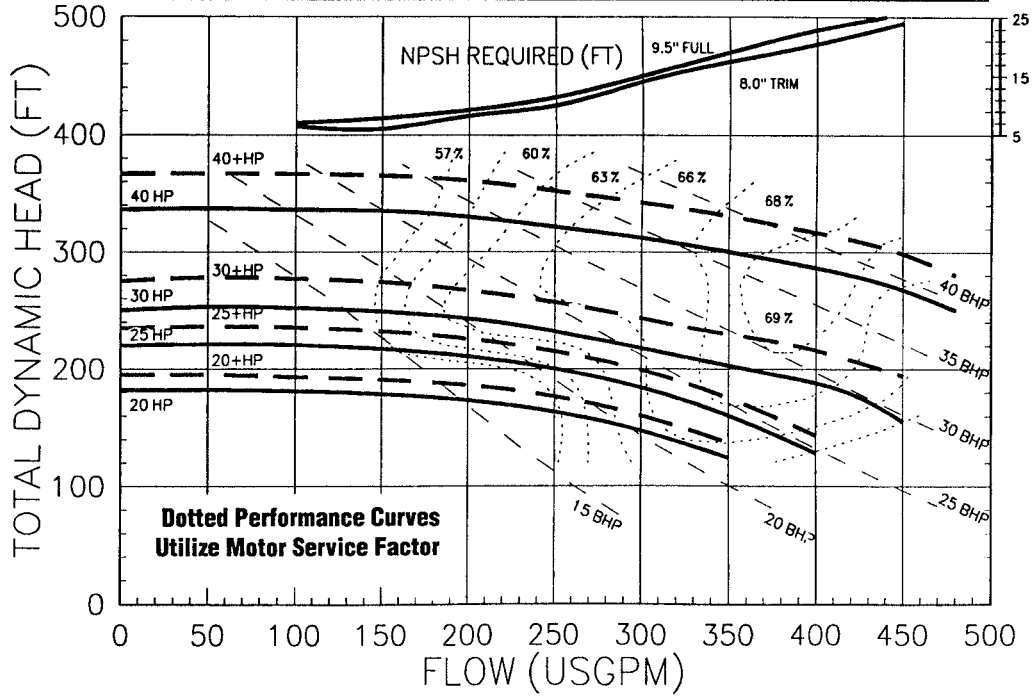

CURVE EPE20M3M	IMPELLER Various	Date	91/08/16	
		MWP (PSI)	250	
SIZE 2.5" x 2"	SPEED 1750	Max. Solids	5/16"	
		IMPELLER DIAMETERS		
		7.5 HP: 9.5" Dia.	5+HP: 8.8" Dia.	
		5 HP: 8.5" Dia.	3+HP: 7.4" Dia.	
		3 HP: 7.2" Dia.		

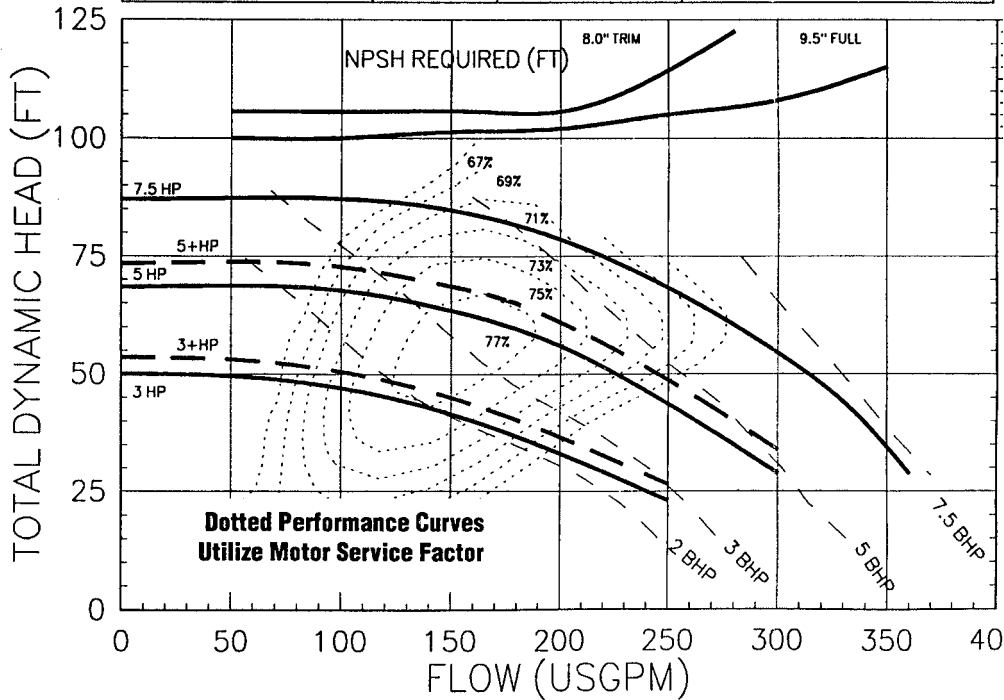

IRRIGATION & INDUSTRIAL EP SERIES

EP (30M4)

Water Systems

Sump and Sewage

Lawn and Sprinkler

Electric Motor Driven

Engine Driven

Frame Mount

Hand Pumps

Irrigation and Industrial

COMPLETE PUMP & MOTOR ASSEMBLY							
	Model Number	Order Number	HP	Weight (lbs.)	Phase	RPM	Size
JM FRAME	EPE30M4M	657137	3	200	3	1725	4 x 3
		657139	5	210			
		657141	7½	250			
EPE30M4M	657136	3	215	1	1725	4 x 3	
	657138	5	260				
	657140	7½	285				

	Model Number	Order Number	HP	Weight (lbs.)	Phase	RPM	Size
JP FRAME	EPE30M4H	657091	25	375	3	3450	4 x 3
		657093	30	450			
		657095	40	510			
		657097	50	625			
		657099	60	665			
EPE30M4M	657237	3	200	3	1725	4 x 3	
	657239	5	210				
	657241	7½	250				
EPE30M4M	657236	3	215	1	1725	4 x 3	
	657238	5	260				
	657240	7½	285				

	Model Number	Order Number	Weight (lbs.)	TR Frame	Max Imp. Dia. @ 3450 RPM	Max RPM	Size
TR	EPT30M4M	657324	184	1	8.0"	2200	4 x 3
	EPT30M4H	657325	205	2	8.0"	3000	
		657326	235	3	9.5"	3450	

PUMP END - KIT COMPONENTS				
Casing	Impeller	Seal	Adapter	Frame Size
656024	656246	656626	656517	143JM-184JM
656024	656246	656626	656519	213JM-215JM
656024	656246	656626	656517	143JM-184JM
656024	656246	656626	656519	213JM-215JM

Casing	Impeller	Seal	Adapter	Frame Size
656024	656241	656622	656523	213JP-256JP
656024	656241	656622	656533	284JP-326JP
656024	656246	656621	656513	143JP-184JP
656024	656241	656622	656523	213JP-256JP
656024	656246	656621	656513	143JP-184JP
656024	656241	656622	656523	213JP-256JP

Casing	Impeller	Seal	Adapter	TR Frame
656024	656246	656621	656513	656711
656024	656241	656622	656523	656712
656024	656241	656622	656533	656713

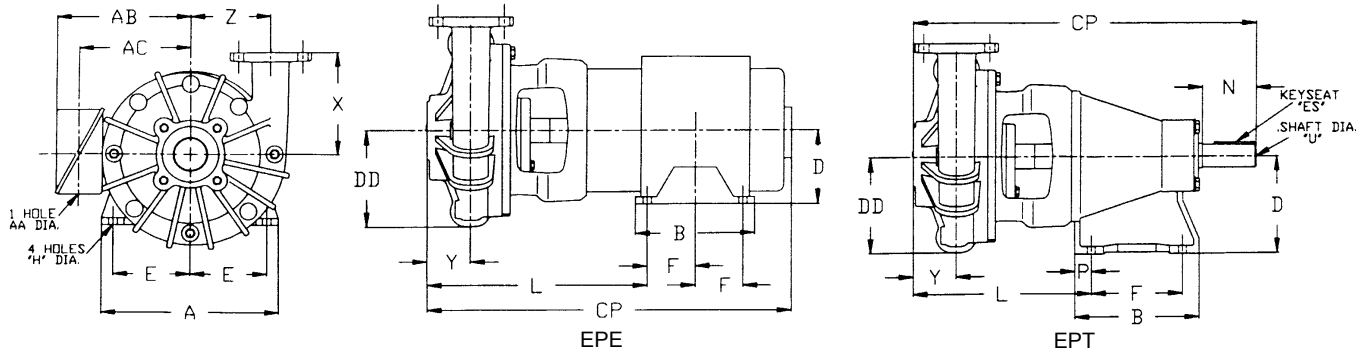

EPE30M4H 3600 RPM ODP - DIMENSIONS MEASURED IN INCHES

Model	HP	Flange		A	AA	AB	AC	B	CP	D	DD	E	F	H	L	X	Y	Z
		Suct.	Disch.															
30M4H	25	4"	3"	12.38	1 ¼	10.69	9.06	12.25	29.87	6.25	6.83	5	5	17/32	15.87	7.5	3.01	6.25
	30			13.88	1 ½	12.62	10.7	12.25	29.87	7	6.83	5.5	4.75	17/32	15.87	7.5	3.01	6.25
	40			13.88	1 ½	12.62	10.7	13.75	31.37	7	6.83	5.5	5.5	17/32	15.87	7.5	3.01	6.25
	50			15.88	2	15.12	12.56	13.75	31.87	8	6.83	6.25	5.25	21/32	16.37	7.5	3.01	6.25

EPT30M4 - DIMENSIONS MEASURED IN INCHES

Model	Flange		Trans.	A	B	CP	D	DD	E	ES	F	H	L	N	P	U	X	Y	Z
	Suct.	Disch.																	
30M4H	4"	3"	TR-2	8.50	8.88	24.35	7.00	6.83	3.50	3/8	6.50	9/16	12.57	3.88	1.29	1.625	7.50	3.01	6.25
30M4H			TR-3	9.50	9.38	25.75	8.00	6.83	4.00	½	7.00	11/16	12.57	4.99	1.31	2.125	7.50	3.01	6.25

*Standard configurations include bronze impeller, single mechanical seal, and ODP motors. For a special shaft seal, motor or impeller option, please contact factory.

IRRIGATION & INDUSTRIAL EP SERIES

EP (30M4)

Water Systems

Sump and Sewage

Lawn and Sprinkler

Electric Motor Driven

Engine Driven

Frame Mount

Hand Pumps

Irrigation and Industrial

CURVE EPE30M4H	IMPELLER Various	Date	91/08/22	IMPELLER DIAMETERS	
	SPEED 3525	MWP (PSI)	250	60 HP: 9.4" Dia.	60+HP: 9.5" Dia.
SIZE 4" x 3"		Max. Solids	3/8"	50 HP: 8.8" Dia.	50+HP: 9.2" Dia.
				40 HP: 8.2" Dia.	40+HP: 8.5" Dia.
				30 HP: 7.4" Dia.	30+HP: 7.6" Dia.
				25 HP: 7.0" Dia.	25+HP: 7.2" Dia.

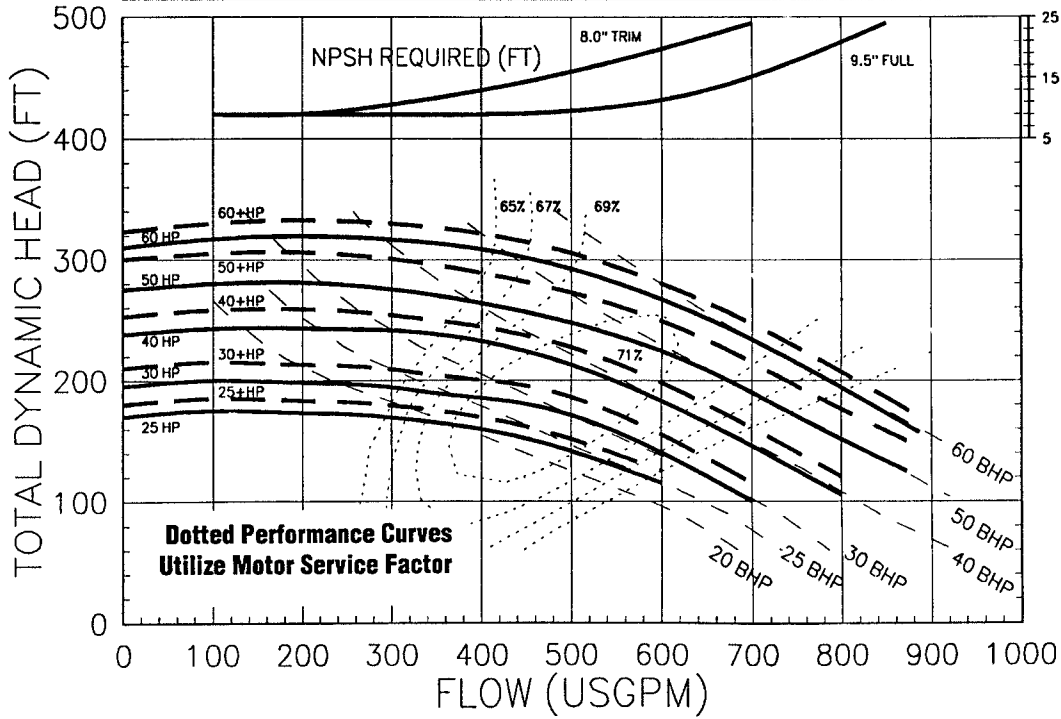

CURVE EPE30M4M	IMPELLER Various	Date	91/08/22	IMPELLER DIAMETERS	
	SPEED 1750	MWP (PSI)	250	7.5 HP: 9.3" Dia.	7.5+HP: 9.5" Dia.
SIZE 4" x 3"		Max. Solids	3/8"	5 HP: 8.2" Dia.	5+HP: 8.5" Dia.
				3 HP: 6.9" Dia.	3+HP: 7.1" Dia.

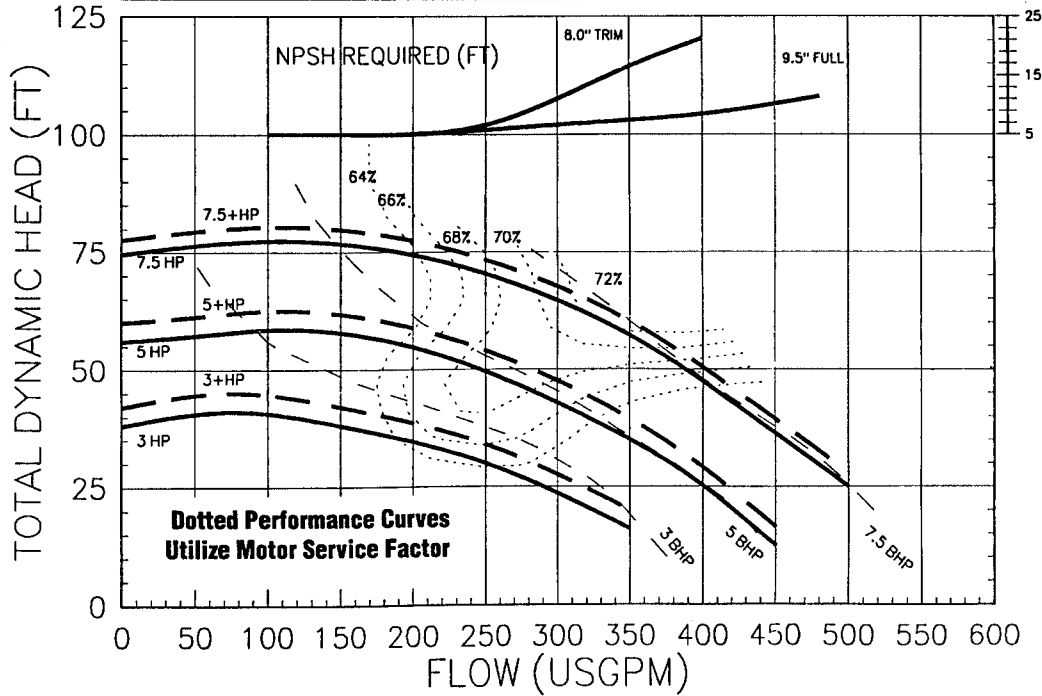

IRRIGATION & INDUSTRIAL

EP SERIES

EP (30M5)

Water Systems

Sump and Sewage

Lawn and Sprinkler

Electric Motor Driven

Engine Driven

Frame Mount

Hand Pumps

Irrigation and Industrial

COMPLETE PUMP & MOTOR ASSEMBLY							
	Model Number	Order Number	HP	Weight (lbs.)	Phase	RPM	Size
JM FRAME	EPE30M5M	657143	5	215	3	1725	4 x 3
		657145	7½	250			
		657147	10	260			
	EPE30M5M	657142	5	260	1	1725	4 x 3
		657144	7½	285			
		657146	10	295			

	Model Number	Order Number	HP	Weight (lbs.)	Phase	RPM	Size
JP FRAME	EPE30M5M	657243	5	215	3	1725	4 x 3
		657245	7½	250			
		657247	10	260			
	EPE30M5M	657249	15	305	1	1725	4 x 3
		657242	5	260			
		657244	7½	285			
	657246	10	295				

	Model Number	Order Number	Weight (lbs.)	TR Frame	Max Imp. Dia. @ 1800 RPM	Max RPM	Size
TR	EPT30M5L	657327	189	1	9.7"	1725	4 x 3
	EPT30M5M	657328	210	2	9.7"		
		657329	240	3	9.7"		

PUMP END - KIT COMPONENTS				
Casing	Impeller	Seal	Adapter	Frame Size
656025	656256	656626	656517	143JM-184JM
656025	656256	656626	656519	213JM-215JM
656025	656256	656626	656519	213JM-215JM

Casing	Impeller	Seal	Adapter	Frame Size
656025	656256	656621	656513	143JP-184JP
656025	656251	656622	656523	213JP-256JP
656025	656251	656622	656523	213JP-256JP

Casing	Impeller	Seal	Adapter	TR Frame
656025	656256	656621	656513	656711
656025	656251	656622	656523	656712
656025	656251	656622	656533	656713

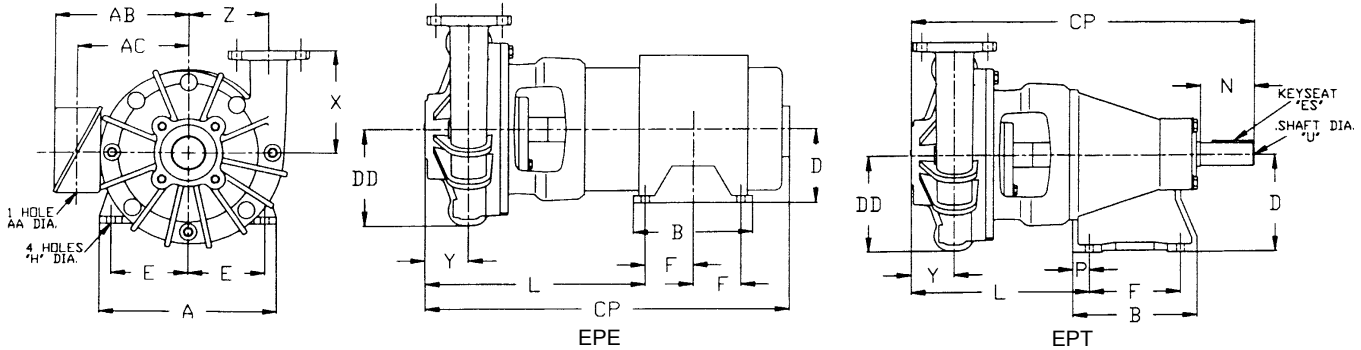

EPE30M5M 1800 RPM - DIMENSIONS MEASURED IN INCHES																			
Model	HP	Flange		A	AA	AB	AC	B	CP		D	DD	E	F	H	L	X	Y	Z
		Suct.	Disch.						DP	TEFC									
30M5M	3	4"	3"	9.00	¾	8.12	6.48	5.75	21.20	23.01	4.50	7.07	3.75	2.25	13/32	13.56	7.50	3.09	6.50
30M5M	5			9.00	¾	8.12	6.48	6.75	22.20	23.56	4.50	7.07	3.75	2.75	13/32	14.01	7.50	3.09	6.50
30M5M	7.5			10.50	1	9.04	7.41	7.00	24.57	26.44	5.25	7.07	4.25	2.75	13/32	15.69	7.50	3.09	6.50
30M5M	10			10.50	1	9.04	7.41	8.50	26.07	27.94	5.25	7.07	4.25	3.50	13/32	15.69	7.50	3.09	6.50
30M5M	15			12.38	1 ¼	10.69	9.06	10.5	28.45	30.32	6.25	7.07	5.00	4.13	17/32	16.19	7.50	3.09	6.50

EPT30M5 - DIMENSIONS MEASURED IN INCHES																				
Model	HP	Flange		Trans.	A	B	CP	D	DD	E	ES	F	H	L	N	P	U	X	Y	Z
		Suct.	Disch.																	
30M5M		4"	3"	TR-2	8.50	8.88	24.67	7.00	7.07	3.50	3/8	6.50	9/16	12.89	3.88	1.29	1.625	7.50	3.09	6.50
30M5M				TR-3	9.50	9.38	26.07	8.00	7.07	4.00	½	7.00	11/16	12.89	4.99	1.31	2.125	7.50	3.09	6.50

*Standard configurations include bronze impeller, single mechanical seal, and ODP motors. For a special shaft seal, motor or impeller option, please contact factory.

IRRIGATION & INDUSTRIAL EP SERIES

EP (30M5)

Water Systems

Sump and Sewage

Lawn and Sprinkler

Electric Motor Driven

Engine Driven

Frame Mount

Hand Pumps

Irrigation and Industrial

CURVE EPE30M5M	IMPELLER Various	Date	92/01/14	IMPELLER DIAMETERS	
	SIZE 4" x 3"	SPEED 1750	MWP (PSI)	250	15 HP: 9.4" Dia. 15+HP: 9.7" Dia. 10 HP: 8.4" Dia. 10+HP: 8.7" Dia. 7.5 HP: 7.8" Dia. 7.5+HP: 8.1" Dia. 5 HP: 7.3" Dia. 5+HP: 7.5" Dia.
		Max. Solids	15/16"		

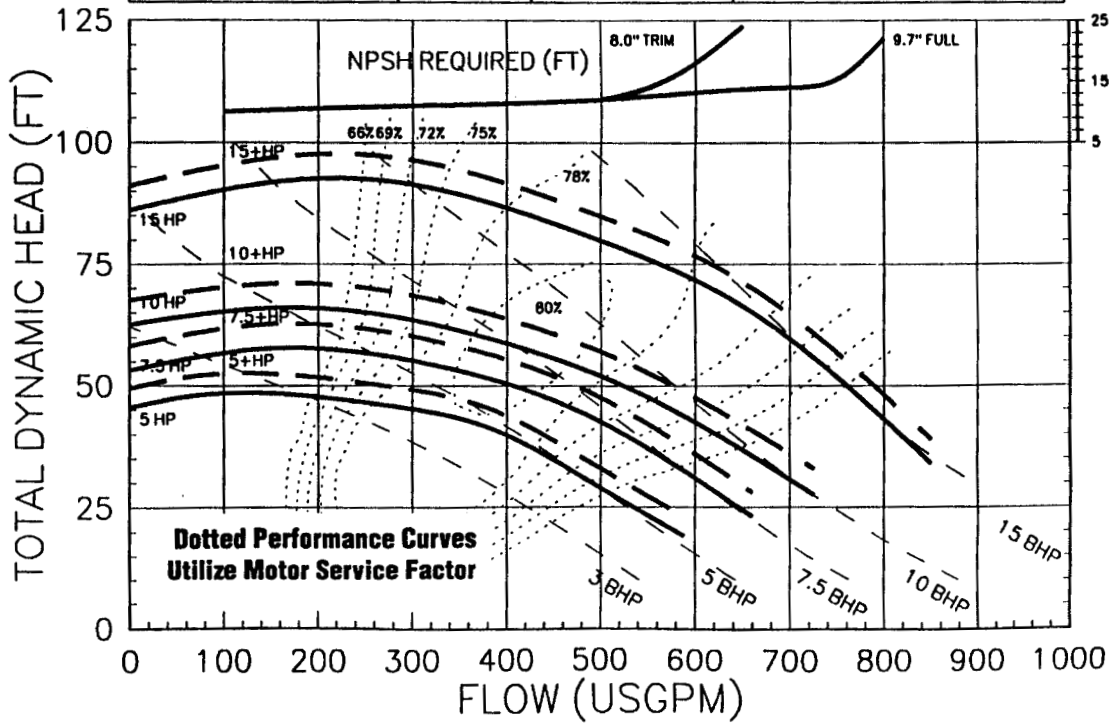

CURVE EPT30M5M	IMPELLER 9.7"	Date	92/01/14	FRAME SELECTION	
	SIZE 4" x 3"	SPEED Various	MWP (PSI)	250	TR-3 UP TO 1750 RPM TR-2 UP TO 1750 RPM TR-1 UP TO 1750 RPM
		Max. Solids	15/16"		

