

6E-CIM SUMP/EFFLUENT PUMP

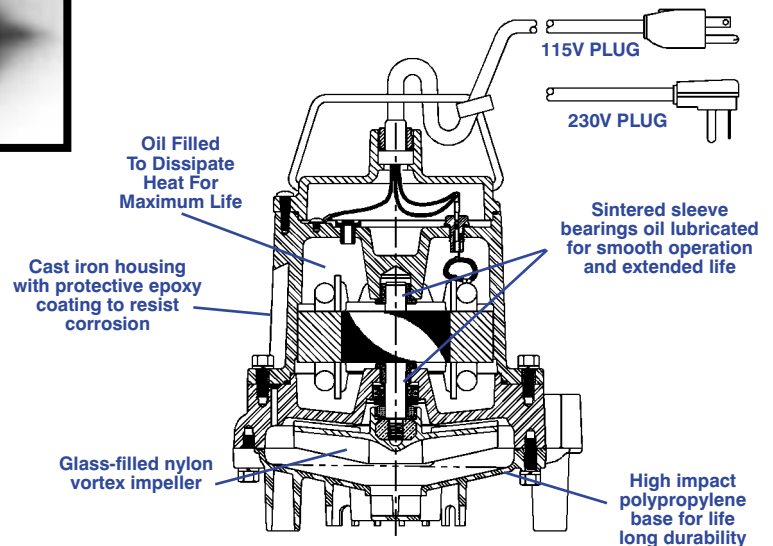

Features

- Handles liquid and solid waste materials up to 1/2" diameter
- Cast iron pump housing with protective epoxy coating for corrosion resistance
- Oil-filled motor housing for lifetime lubrication and rapid heat dissipation
- 1/3 hp Shaded Pole Motor
- Stainless steel screws, bolts and handle
- Mechanical seals (stainless steel spring, nitrile parts, carbon and ceramic faces)
- Bearings: upper and lower sintered sleeve bearings
- Thermal overload protection for extended motor life
- Manual and Automatic models
- Automatic operation has 7"-10" "On" level range and 2"-5" "Off" level range
- Piggyback Mechanical Float Switch
- All 115 volt models are UL Listed



The model 6E Series Sump and Effluent Pumps are for residential and light commercial use. Pumps feature a 1-1/2" discharge with a lift of 20', polypropylene base and polycarbonate cover.

Little Giant Pump Co.

6E-CIM SUMP/EFFLUENT PUMP

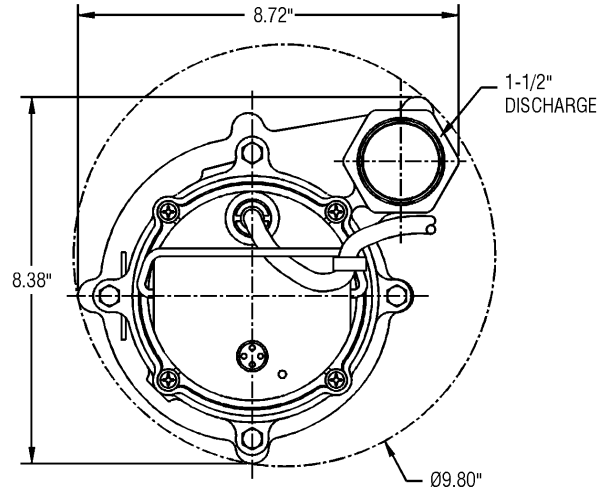
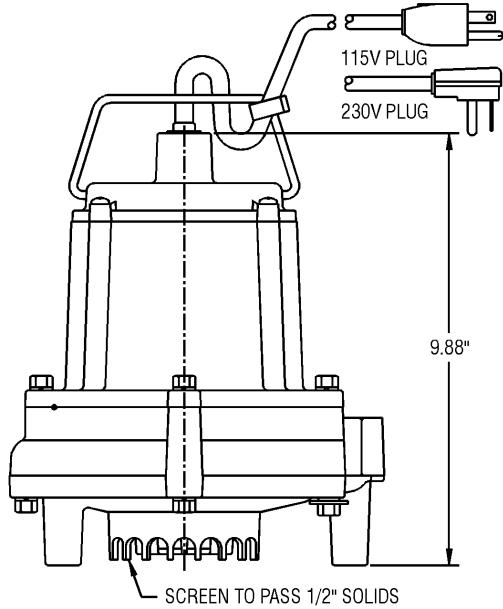

Specifications

MODEL NO.	ITEM NO.	LISTING	HP	VOLTS	SOLIDS (DIA.)	RUNNING AMPS/WATTS	PERFORMANCE (GPM @ HEAD)			SHUTOFF (FT.)	PS.I.	PWR CORD (FT.)	WEIGHT (LBS)	DIMENSIONS (H x L x W in.)
							5'	10'	15'					
6E-CIM	506500	N/A	1/3	127	1/2"	10/750	54	44	31	20	8.7	25	28	9.9 x 8.8 x 8.5
6E-CIM	506735	CSA	1/3	230*	1/2"	4.8/890	50	42	27	20	8.7	25+	28	9.9 x 8.8 x 8.5
6E-CIM	506775	UL/CSA	1/3	115	1/2"	10/750	50	42	27	20	8.7	25	28	9.9 x 8.8 x 8.5
6E-CIM	506711	UL/CSA	1/3	115	1/2"	10/750	50	42	27	20	8.7	25	28	9.9 x 8.8 x 8.5
6E-CIM	506730	UL/CSA	1/3	230*	1/2"	4.8/890	50	42	27	20	8.7	15	28	9.9 x 8.8 x 8.5
6E-CIM	506710	UL/CSA	1/3	115	1/2"	10/750	50	42	27	20	8.7	10	27	9.9 x 8.8 x 8.5
6E-CIM-RFSN	506740	UL/CSA	1/3	115	1/2"	10/750	50	42	27	20	8.7	10	27	9.9 x 8.8 x 8.5

*50/60 HZ. Performance Data Based on 60 Hz. CIM - Manual
RFSN - Piggy Back Mechanical Float Switch
+ w/out Plug

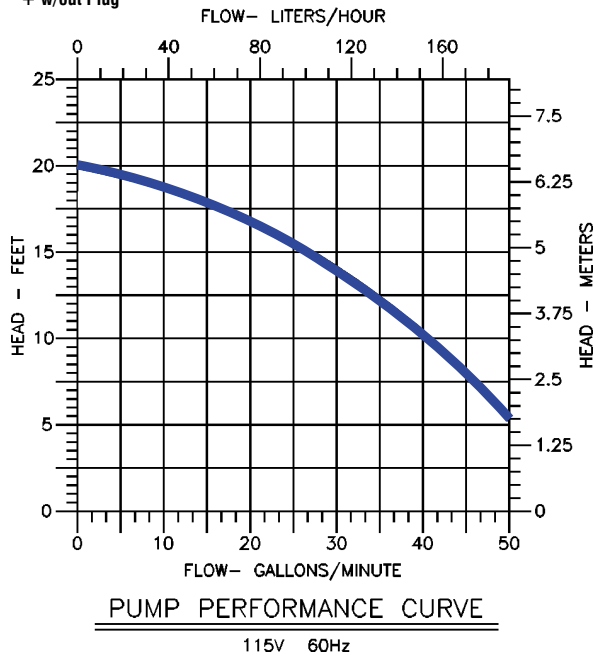

Construction

Cover	Polycarbonate
Motor Housing	Epoxy Coated Cast Iron
Impeller Material	Nylon
Impeller Type	Vortex
Volute	Epoxy Coated Cast Iron
Power Cord	SJTW-A
Mechanical Shaft Seal	Nitrile with carbon and ceramic faces
Fasteners	Stainless Steel
Shaft	Cold Rolled Steel
Bearings	Upper and lower sintered sleeve bearings

Little Giant Pump Co.

PO Box 12010
Okla. City, OK 73157

Phone: 405.947.2511
Fax: 405.228.1550

www.LittleGiantPump.com

Form No. 994465 — 6/00