

Little GIANT[®]

Pump Company

2-M D



Features

- Thermally Protected, Open, Fan-Cooled Motor
- Sleeve Bearings
- 6' Power Cord with 3-Prong Plug
(No plug on 230V)
- Specific Gravity to 1.1
- Fluid Temperature to 150 Degrees F.
- Ambient Air Temperature to 77 Degrees F.
- NOTE: Consult your local distributor or the factory for applications with higher ambient temperatures, specific gravities and viscosities.

Construction

- Volute — Glass-filled Polypropylene
- Housing — Glass-filled Polypropylene
- Impeller — Glass-filled Polypropylene & Ceramagnet "A" (Barium Ferrite)
- Shaft — Titanium
- Thrust Washers — Titanium
- O-Ring — Nitrile

The Little Giant MD series features leakproof, seal-less magnetic drives and are designed for in-line, non submersible use. Volute and magnet housing are glass-filled polypropylene for excellent chemical resistance. Impeller is glass-filled polypropylene and Ceramagnet "A" (Barium Ferrite). Shaft and thrust washers are Titanium for excellent wear and trouble-free service. Pumping heads are easily rotated, cleaned or serviced with no special tools required. Spindle shaft is supported at both ends to prevent impeller damage during start-up and stop of pump.

Little Giant Pump Co.

2-MD

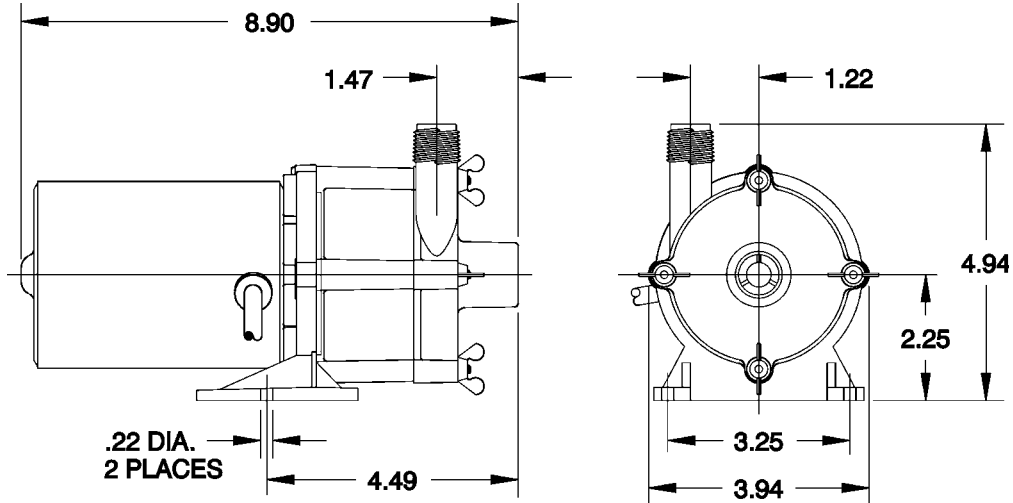

NOTE: Designs and dimensions may vary for various reasons (i.e. type of motor). This information should be used as general guide rather than an unqualified guarantee. Specifications are subject to change without prior notice.

Specifications

Model No.	Item No.	Intake	Discharge	Listing(s)	HP	Volts	Hertz	Amps	Watts	Performance (GPH @ Head)				Shut Off		Pwr. Cord (ft)	Weight (Lbs.)
										1'	3'	6'	9'	Feet	PSI		
2-MD	580002	1/2" FNPT	1/2" MNPT	UR/C-CSA	1/30	115	60	1.5	100	510	465	410	330	14.6	6.3	6	6.25
2-MD	580012	1/2" FNPT	1/2" MNPT	UR/C-CSA	1/30	230	50/60	.65/.64	105/100	510	465	410	330	14.6	6.3	6	6.25
2-MD	580098	1/2" FNPT	1/2" MNPT														1.67

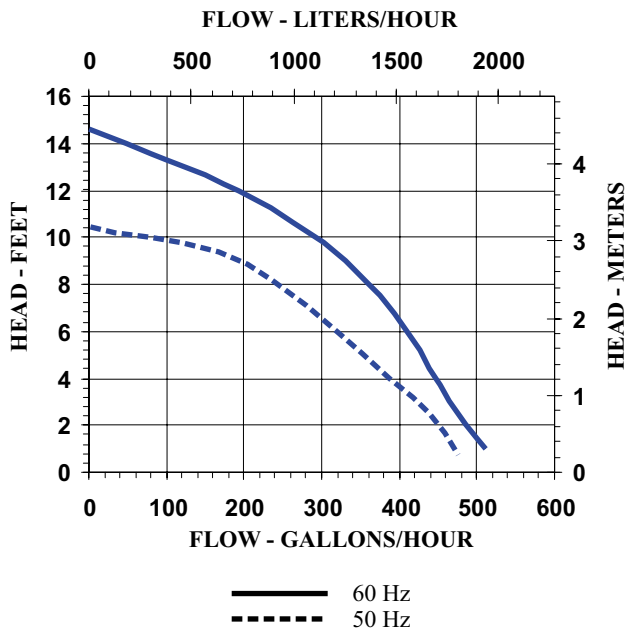
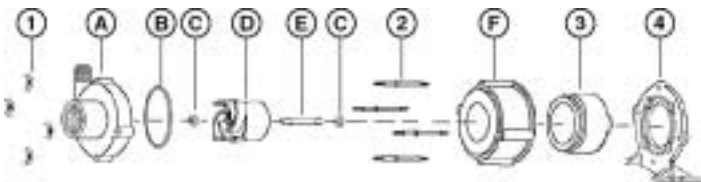

Replacement Parts

ITEM	PART NO.	DESCRIPTION
A	180079	Volute
B	924007	O-Ring
C	921067	Thrust Washer
D	181165	Impeller
E	180058	Shaft
F	180004	Housing
1	920003	Wing Nut
2	911403	Stud, Collared
3	180602	Drive Magnet
4	180031	Mtg. Bracket

Note: Parts A-F Contact Fluid.

Little Giant Pump Co.
 PO Box 12010
 Okla. City, OK 73157
 Phone: 405.947.2511
 Fax: 405.228.1550
www.LittleGiantPump.com