

Iwaki Walchem's World of Sealless Non-Metallic Pumps



Aggressive or High Purity CHEMICAL DELIVERY Pumps



High purity metering pumps, for SEMICONDUCTOR manufacturing



High Purity Recirculation pumps for SEMICONDUCTOR manufacturing



Compact recirculating pumps, for COOLING LOOPS, WET ETCH, COPPER PLATING, and other applications

WMD, MD & MDH MAGNETIC DRIVE PUMPS



IWAKI WALCHEM Corporation, Five Boynton Road, Holliston, MA 01746 USA
Phone: 508-429-1440, Fax: 508-429-1386, www.iwakiwalchem.com, info@iwakiwalchem.com



www.iwakiwalchem.com

Combining Walchem's 28 years of chemical injection and control experience with Iwaki's 46 years of pump design engineering, IWAKI WALCHEM offers the best chemical handling equipment for use in Process, Original Equipment, Industrial and Semiconductor applications.

This brochure proudly highlights our line of superbly engineered non-metallic, small mag drive pumps.



MDH Dimensions

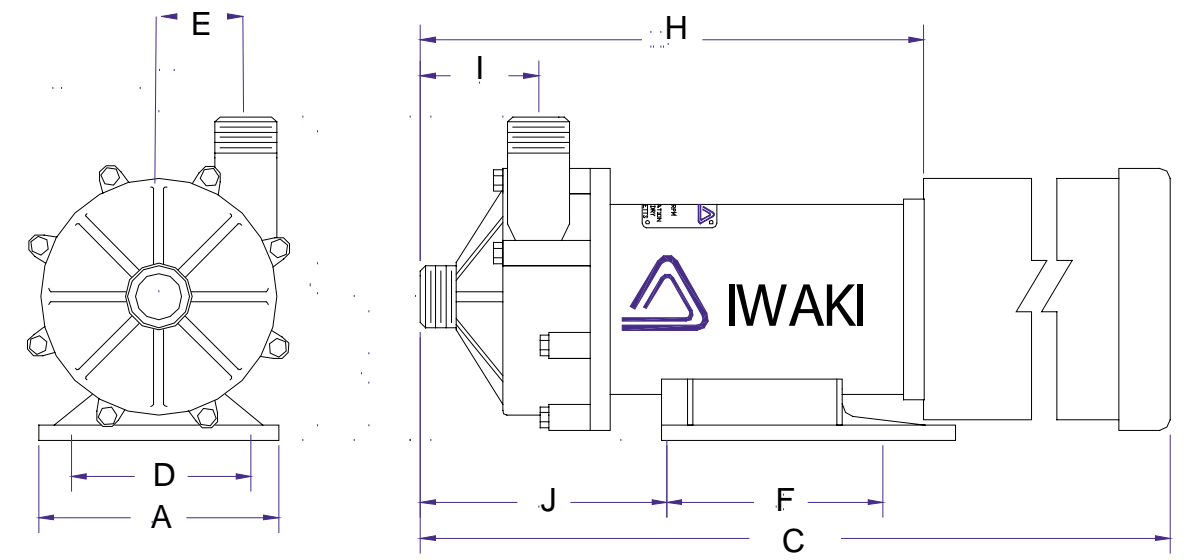

Specifications (Fluoroplastic)

| Model | Connections Suct. (in.) | Disch. (in.) | Motor Output (hp) | Motor Speed (rpm) | Max. Flow (gpm) | Max. Head (ft) | Max. Working Pressure (psi) | S.G.* | Wgt. Pump Only (lbs) |
|------------|-------------------------|--------------|-------------------|-------------------|-----------------|----------------|-----------------------------|-------|----------------------|
| MDH-F400-G | 1 1/2 | 1 1/2 | 3/4 | 3600 | 66.0 | 43.0 | 23.0 | 1.2 | 14 |
| MDH-F401-G | 1 1/2 | 1 1/2 | 1 1/2 | 3600 | 92.0 | 70.0 | 34.0 | 1.2 | 24 |
| MDH-F422-X | 2 | 1 1/2 | 2 | 3500 | 95.0 | 80.0 | 43.0 | 1.2 | 33 |
| MDH-F423-X | 2 | 1 1/2 | 3 | 3500 | 120.0 | 77.0 | 43.0 | 1.2 | 35 |
| MDH-F425-X | 2 | 1 1/2 | 5 | 3500 | 150.0 | 102.0 | 57.0 | 1.2 | 44 |

Specifications (Polypropylene)

| Model | Connections Suct. (in.) | Disch. (in.) | Motor Output (hp) | Motor Speed (rpm) | Max. Flow (gpm) | Max. Head (ft) | Max. Working Pressure (psi) | S.G.* | Wgt. Pump Only (lbs) |
|-----------|-------------------------|--------------|-------------------|-------------------|-----------------|----------------|-----------------------------|-------|----------------------|
| MDH-400-6 | 1 1/2 | 1 1/2 | .5 | 3600 | 74.0 | 37.0 | 23.0 | 1.1 | 14 |
| MDH-400-7 | 1 1/2 | 1 1/2 | .75 | 3600 | 68.0 | 42.0 | 23.0 | 1.1 | 14 |
| MDH-401-6 | 1 1/2 | 1 1/2 | 1 | 3600 | 85.5 | 62.0 | 34.0 | 1.1 | 24 |
| MDH-401-7 | 1 1/2 | 1 1/2 | 1.5 | 3600 | 90.0 | 67.0 | 34.0 | 1.1 | 24 |
| MDH-422-6 | 2 | 1 1/2 | 2 | 3500 | 95.0 | 79.0 | 43.0 | 1.2 | 33 |
| MDH-423-6 | 2 | 1 1/2 | 3 | 3500 | 120.0 | 78.0 | 43.0 | 1.2 | 35 |
| MDH-425 | 2 | 1 1/2 | 5 | 3500 | 150.0 | 102.0 | 57.0 | 1.2 | 44 |

* Note: Higher S.G. can be handled with impeller trim

Dimensions - units in inches

| Model | Motor Required | | A | B | C | D | E | F | G | H | I | J |
|-----------------|----------------|-------|-------|-------|-------|------|------|-------|------|-------|------|------|
| | HP | NEMA | | | | | | | | | | |
| MDH-(F) 400 | 1/2 & 3/4 | 56C | 5.51 | 8.27 | 18.00 | 4.33 | 2.01 | 3.86 | 3.74 | 8.75 | 3.19 | 5.67 |
| MDH-(F) 401 | 1 & 1 1/2 | 56C | 6.30 | 9.76 | 20.75 | 5.12 | 2.26 | 5.12 | 4.53 | 11.50 | 3.84 | 7.01 |
| MDH-(F) 422/423 | 2 & 3 | 145TC | 10.24 | 9.81 | 21.23 | 8.19 | 2.56 | 7.87 | 4.53 | 11.26 | 3.27 | 5.83 |
| MDH-(F) 425 | 5 | 184TC | 10.24 | 10.59 | 23.68 | 9.06 | 2.56 | 10.28 | 5.31 | 12.24 | 3.27 | 5.91 |

- Notes:
1. All dimensions in inches
 2. Optional flanges add 0.25" to length and height
 3. Tolerances may vary with motor

MDH Family Curve

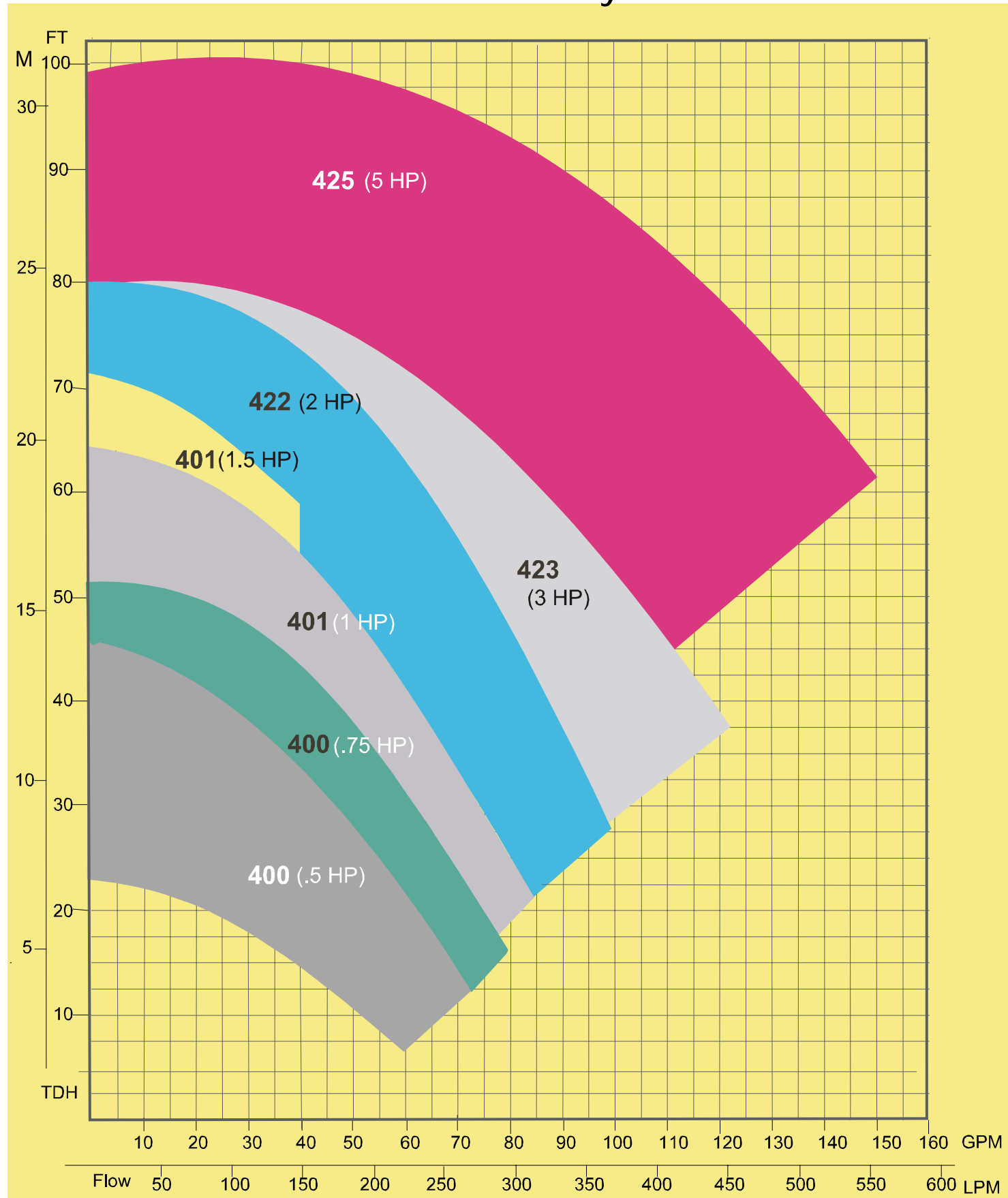

All pumps manufactured by Iwaki Walchem are individually performance tested for output and pressure.

Magnetic Drive Pumps Reinvented, Re-Engineered, Refined

Iwaki Walchem is the world leader in small magnetically coupled centrifugal pump technology. Combining Walchem's three decades of chemical pump and control experience with Iwaki's five decades of pump engineering and manufacturing excellence, Iwaki Walchem offers the premier line of non-metallic centrifugal pumps available for many equipment machinery applications.



Semiconductor

The world's most advanced surface preparation, cleaning and etching equipment manufacturers rely on our MD and WMD line of pumps. When particulate and ionic contamination are critical issues, customers choose our pumps to deliver outstanding purity at an outstanding value.

Laser

Cosmetic, dental and optical laser manufacturers worldwide rely on our WMD pumps for high performance, small package, quiet operation and long life. Special motors used in medical applications, or low voltage motors for easy CE approval, are no problem.

Chillers/Coolers

Chiller manufacturers specify our WMD-30Z and MD-70Z pumps for their extremely high pressure generation. Our steep pump performance curves come close to matching positive displacement pumps.

Fuel Cells

Fuel Cell manufacturers look to Iwaki Walchem WMD pumps for long life, high pressure and low power usage for coolant recirculation.

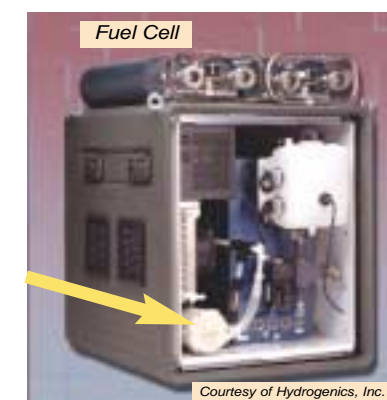

Copper Plating

Whether for semiconductor wafers, circuit board manufacturing or general industry; our WMD, MD and MDH pumps excel at plating, fluid transfer and recirculation.

Deionization and R.O.

Applications are handled better by WMD because of the pump's low ionic/particulate contamination quotient.

Aquaculture

Our aquaculture and fish breeding customers find the WMD the best value in the industry.

X-Ray & Photo Imaging

Manufacturers install small Iwaki Walchem mag drives in a space-efficient "head down" position without concern over air-binding or meltdown.



Kidney Dialysis Centers

MDH is chosen for distribution of dialysate due to its high reliability and low downtime.

Pulp & Paper Mills

MDH-F pumps sodium hypochlorite best because the pump is so highly resistant to long term chemical stress cracking.

Water Treatment

Facilities operators use our sealless mag drives for handling ultra-wet, low surface tension fluids such as potassium hydroxide.

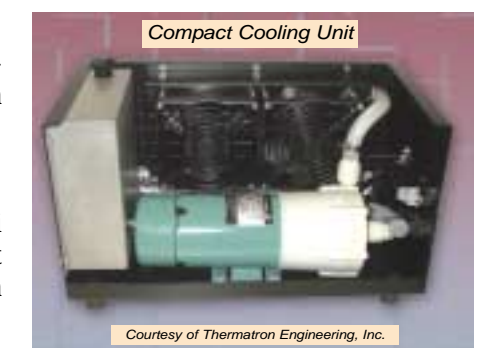

MDH Mag Drive Pumps

Contrasted to conventional mag drives, WMD & MD mag drive pumps boast a series of intelligent engineering enhancements.

Our selection contains motors to meet the cost/life range needs and they can be mounted almost anywhere. Most carry UL/CSA approval.

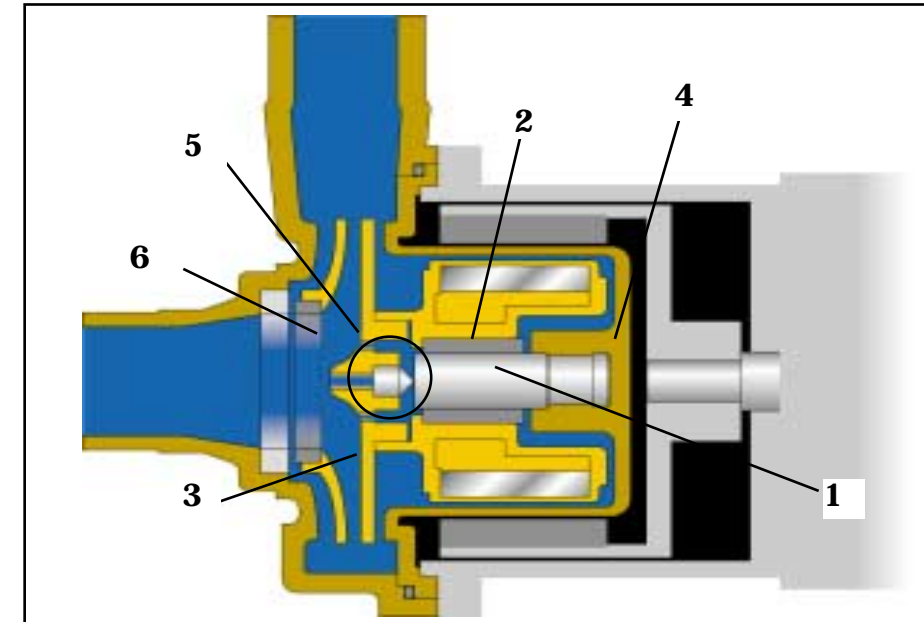

MDH-D — Now REAL Dry Run Capability!

1. Spindle – A robust cantilevered spindle is anchored in the rear of our reinforced containment shell. The new spindle, made of alumina ceramic or stainless steel, is four times the mass of competing designs. Its inertial stability minimizes noise and vibration. Having no front spindle support, suction flow is unrestricted. NPSHr is markedly reduced. The spindle's front face is the platform for the innovative pinpoint bearing.

2. Bearing – Rifled bearing forces fluid across the spindle surface to create a "liquid sleeve," resulting in reduced friction and rapid, even cooling of all bearing surfaces, prolonging pump life.

3. Impellers – High efficiency closed impellers are a separate component that mates to the magnet capsule. MDH(F) series impellers can be trimmed to meet precise performance specifications across a wide range of specific gravity ranges.

4. Rear Casing – Large hydraulic efficiencies are maintained by our use of a non-metallic rear casing, eliminating eddy current heat found in metal magnetic drive pumps.

5. Patented Pinpoint Bearing System – With our new pinpoint bearing system, conventional rear thrust surfaces have been designed-out. During cavitation or dry run, rear thrust is balanced on the impeller-mounted pinpoint bearing. Frictional contact is thereby virtually eliminated. Heat generation, typical of other sealless pumps, is reduced exponentially.

Traditional magnetic drive pumps have always been subject to catastrophic failure as a result of dry run or episodic cavitation. Liquid/air flow across bearing surfaces shuts down under adversity. Now, our new pinpoint bearing leaves the internal cooling circuit wide open. The magnet capsule is, in all cases, prevented from any contact with the rear casing.

6. Mouth Ring – Made of rein-

forced PTFE, the replaceable mouth ring generates minimal heat and therefore prevents thermal deformation. It is designed with positioning tabs to assure perfect face mating.

Additional Benefits:
NPT male threads prevent cracking of housing due to overtightening.

Modular replaceability of impeller, magnet capsule, mouth ring and rifled flush bearing reduces maintenance expense and maximizes application flexibility.

During manufacture, drive magnet carriers are dynamically balanced, referencing ISO standards 1940 & 2372.

Cast iron motor bracket further increases inertial stability, reduces vibration and dampens noise.

Thermoplastic foot mount eliminates "wet floor" corrosion typical of metallic pump mounts.

Flange connectors available.

Patented Pinpoint Bearing



An industrial pump that looks, acts and runs like a heavy duty process pump, MDH boasts significant comparison to process pumps and striking contrast to conventional industrial pumps. Competitive price and outstanding performance envelope make MDH an easy choice.



www.iwakiwalchem.com

WMD/MD Mag Drive Pumps

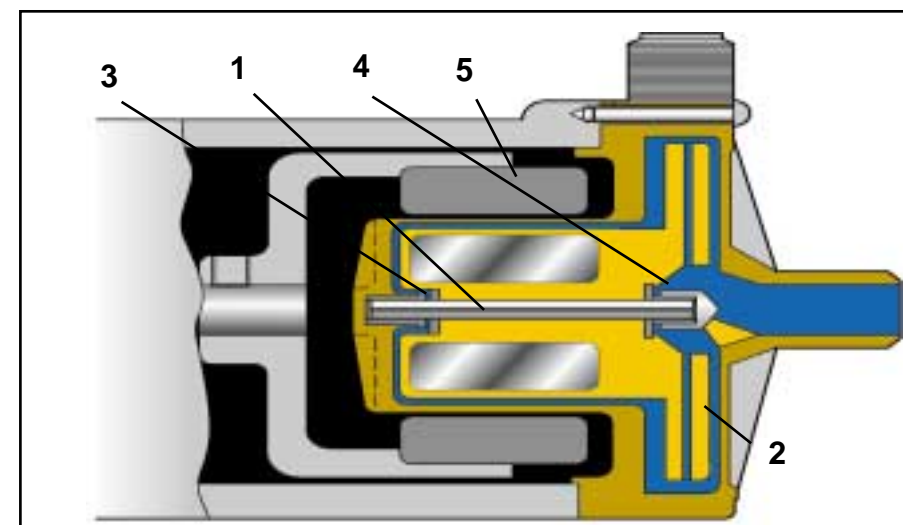

1. Unique Internal Cooling Circuit - Hollow rotating spindle creates a positive, forced cooling path, lubricating bearing surfaces and actively purging gases & heat. Fluid is not trapped in the rear casing but seeks a low pressure escape to the eye of the impeller through the hollow spindle. Frictional heat is thereby conducted out of the rotating element. Any gas/air is sucked from the rear casing and expelled in a perpetual purge cycle.

Unique double bearing system allows cooling circuit liquid to continually "wash" front and rear radial bearings, extending bearing life.

2. Impeller - Alumina ceramic or SiC spindles are bored, turned and highly polished. This precision machined spindle forms the center of the driven magnet. The impeller/capsule, keyed off this machined center, is molded around the spindle/magnet assembly for perfect concentricity of the rotating element. In the final step, two precision-ground ceramic thrust rings are press fitted in perfect parallel alignment onto the front and rear of the rotating spindle. Substantially reduced hydraulic noise is a major feature of all WMD/MD impellers. Great pains are taken in

the molding/finishing process to eliminate tangential misalignment. Hardened, plated mold surfaces yield smooth, uniform parts.

Balance holes to minimize axial thrust are designed into most WMD/MD impellers. Traditionally employed only in large process pumps, balance holes are yet another performance detail characteristic of Iwaki Walchem WMD/MD pump engineering.

3. Bearings/Thrust Surfaces-High lubricity fluoropolymer bearings minimize mechanical losses typical of conventional mag drive pumps. High purity SiC radial bearings handle the most aggressive or ultrapure chemistries. Particulate shedding is reduced to lowest levels of any magnetic drive offering.

4. PTFE/front thrust surface - aids hydraulic balance and minimizes flashing. Large rear thrust surface guards against axial forces caused by cavitation or gas entrainment. SiC surfaces are "channeled" to remain

wetted, even during adverse operating conditions.

5. Drive Magnet - Dynamically balanced barium ferrite drive magnets provide best magnet torque, dollar-for-dollar. Depending on torque requirements, 4, 6 and 8 pole magnets are used. Die cast magnet carrier creates a fly wheel effect, which adds to the magnet safety factor.

Motor Matching - Offering more motor/pump configurations than any other manufacturer easily allows tailored pump applications. Premium, high efficiency motors are used throughout the line. Totally enclosed, permanent split capacitor motors are compact, cool and economical. Tolerance to voltage variation without overheating and 50/60 Hz operation allows the product to be used in a worldwide market.

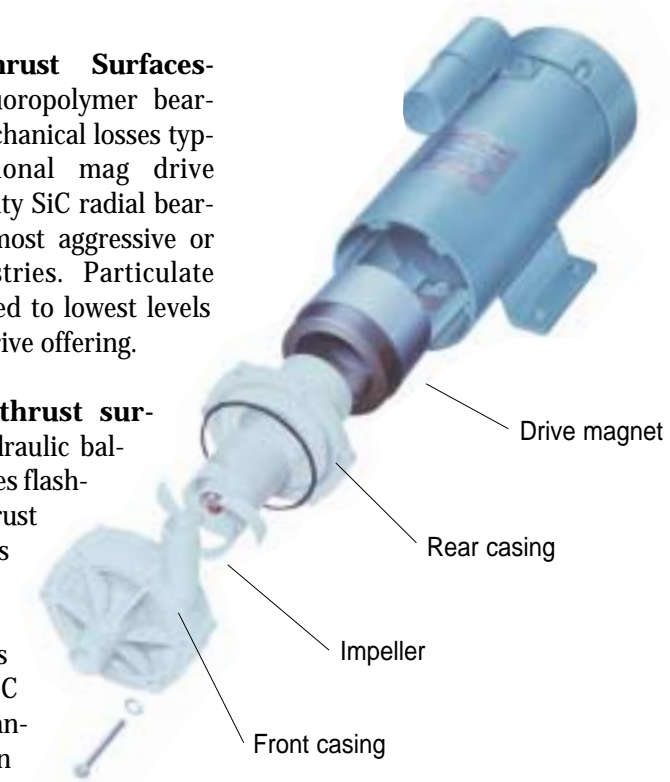

Polypropylene

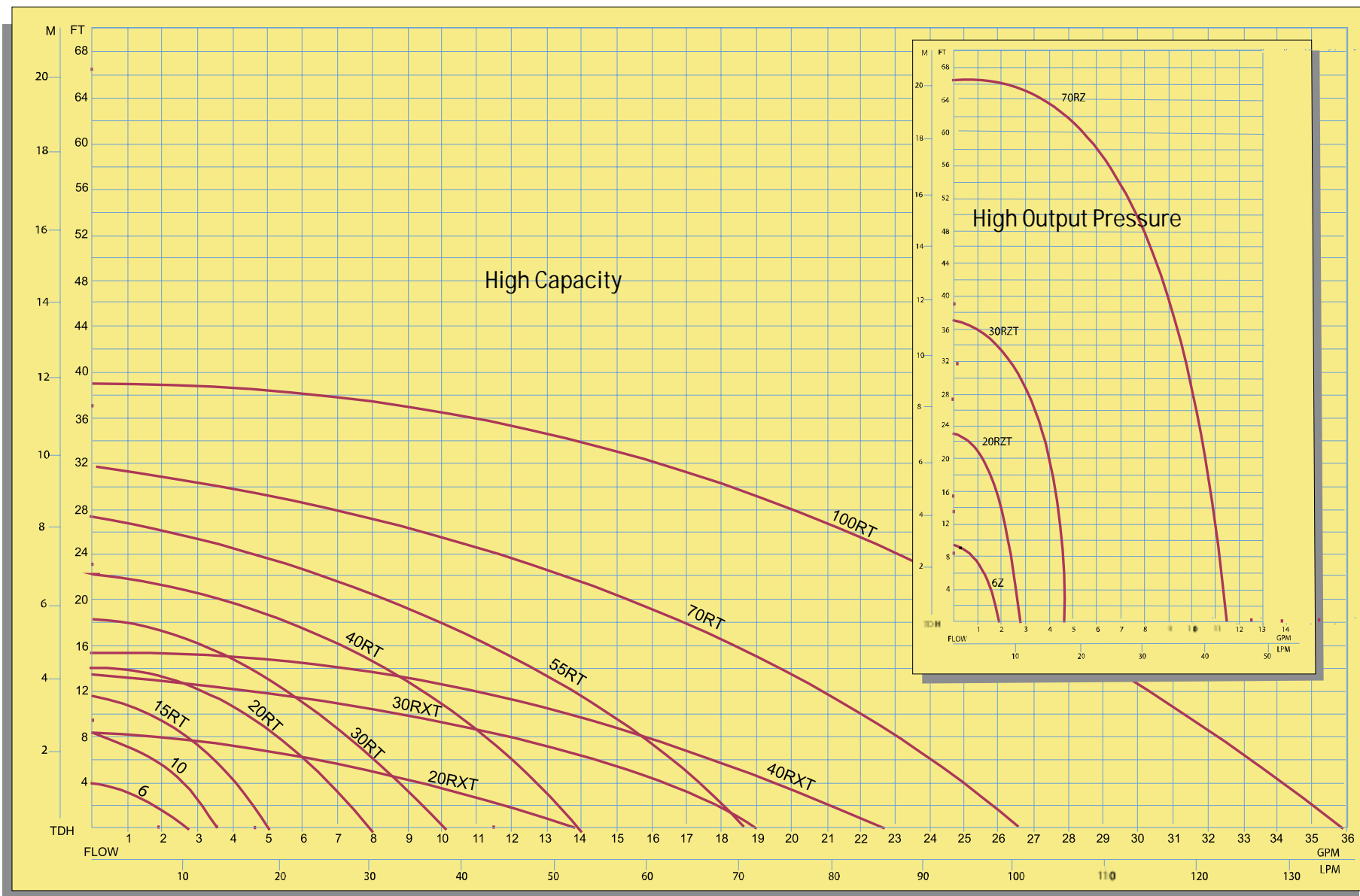

Specifications

| Model (POLYPROPYLENE) | Connections Hose | Connections NPTM | Motor Output (hp) | Motor Speed (rpm) | Amps | Max. Flow (gpm) | Max. Head (ft) | Max. Sys. Pressure (psi) | S.G. | Weight (lbs.) |
|-----------------------|------------------|------------------|-------------------|-------------------|------|-----------------|----------------|--------------------------|------|---------------|
| MD-6 | 1/2 | - | 1/250 | 3100 | .25 | 2.3 | 4.5 | 2.8 | 1.2 | 2 |
| MD-10 | 1/2 | - | 1/125 | 2900 | .40 | 3.1 | 6.8 | 4.3 | 1.1 | 2 |
| WMD-15R(T) | 1/2 | 1/2 | 1/75 | 3100 | .82 | 5.0 | 11.1 | 7.2 | 1.3 | 6 |
| WMD-20R(T) | 5/8 | 3/4 | 1/38 | 3100 | .48 | 8.2 | 14.1 | 10.0 | 1.1 | 7 |
| WMD-20RX(T) | 1 | 1 | 1/38 | 3100 | .50 | 13.7 | 8.2 | 5.7 | 1.3 | 7 |
| WMD-20RZ(T) | 5/8 | 3/4 | 1/38 | 3100 | .53 | 2.9 | 22.6 | 14.2 | 1.1 | 7 |
| WMD-30R(T) | 3/4 | 3/4 | 1/16 | 3150 | 1.0 | 10.0 | 17.7 | 11.6 | 1.3 | 9 |
| WMD-30RX(T) | 1 | 1 | 1/16 | 3150 | 1.0 | 19.0 | 13.5 | 8.5 | 1.1 | 9 |
| WMD-30RZ(T) | 5/8 | 3/4 | 1/16 | 3150 | 1.0 | 4.6 | 36.1 | 24.2 | 1.0 | 9 |
| WMD-40R(T) | 3/4 | 3/4 | 1/12 | 3200 | 1.9 | 13.7 | 21.3 | 14.2 | 1.1 | 10 |
| WMD-40RX(T) | 1 | 1 | 1/12 | 3200 | 1.9 | 22.4 | 15.4 | 10.0 | 1.1 | 10 |
| MD-55R(T)1 | 1 | 1 | 1/9 | 3400 | 1.6 | 18.4 | 26.9 | 17.1 | 1.2 | 10 |
| MD-70R(T)1 | 1 | 1 | 1/4 | 3400 | 2.8 | 25.6 | 31.8 | 21.3 | 1.0 | 13 |
| MD-70RZ(T) | 3/4 | 3/4 | 1/4 | 3400 | 3.8 | 11.4 | 66.6 | 42.7 | 1.0 | 13 |
| WMD-100R(T) | 1 | 1 | 1/3 | 3300 | * | 35.6 | 39.0 | 25.6 | 1.2 | * |

* varies with motor

| Model (FLUOROPLASTIC) | Connections Hose | Connections NPTM | Motor Output (hp) | Motor Speed (rpm) | Amps | Max. Flow (gpm) | Max. Head (ft) | Max. Sys. Pressure (psi) | S.G. | Weight (lbs.) |
|-----------------------|------------------|------------------|-------------------|-------------------|------|-----------------|----------------|--------------------------|-----------|---------------|
| WMD-30FX | - | 1/2 | 1/16 | 3200 | 0.9 | 3.2 | 35.2 | 17.0 | 1.3 (1.5) | 9 |
| WMD-30FY | - | 1/2 | 1/16 | 3200 | 0.9 | 3.2 | 26.0 | 17.0 | 1.5 (1.8) | 9 |
| WMD-30FZ | - | 1/2 | 1/16 | 3200 | 0.9 | 2.6 | 24.0 | 21.3 | 1.9 (2.1) | 9 |
| MD-55FY | - | 1 | 1/9 | 3300 | 1.6 | 16.0 | 20.0 | 21.3 | 1.3 (1.5) | 10 |
| MD-55FZ | - | 1 | 1/9 | 3300 | 1.6 | 13.0 | 19.0 | 21.3 | 2.0 (2.2) | 10 |
| WMD-100FY | - | 1 | 1/3 | 3300 | * | 36.0 | 38.0 | 31.2 | 1.3 (1.6) | * |
| MD-100FY | - | 1 | 1/3 | 3300 | 3.4 | 36.0 | 38.0 | 31.2 | 1.3 (1.6) | 18 |
| WMD-100FZ | - | 1 | 1/3 | 3300 | * | 28.0 | 27.2 | 31.2 | 1.9 (2.2) | * |
| MD-100FZ | - | 1 | 1/3 | 3300 | 3.4 | 28.0 | 27.2 | 31.2 | 1.9 (2.2) | 18 |

* Call factory for specifications on motor options.

Fluoroplastic

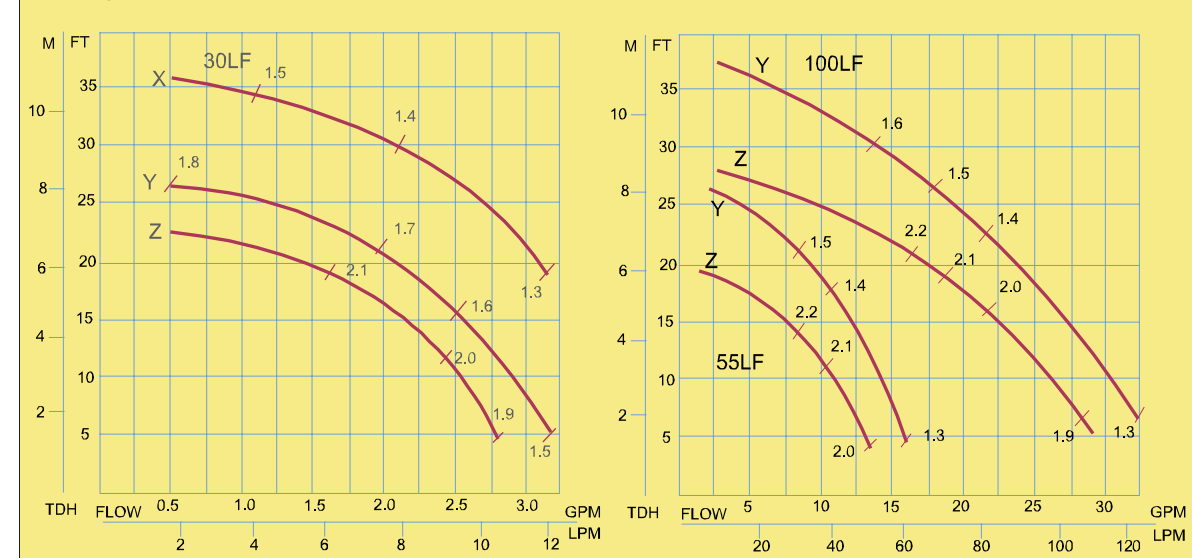

Dimensions (Polypropylene) – units in inches

| Model | W | H | L | a | b | c | d | e | f |
|-------------|------|------|-------|------|-------|------|------|------|------|
| MD-6 | 2.91 | 3.63 | 4.09 | — | 2.88 | 2.36 | 1.77 | 1.22 | 0.67 |
| MD-10 | 2.91 | 3.63 | 4.09 | — | 2.88 | 2.36 | 1.77 | 1.22 | 0.67 |
| WMD-15R(T) | 3.50 | 4.48 | 9.97 | 2.37 | 3.03 | 2.62 | 2.15 | 1.52 | 0.84 |
| WMD-20R(T) | 3.50 | 4.36 | 10.53 | 2.37 | 4.97 | 2.62 | 1.93 | 1.30 | 1.12 |
| WMD-20RX(T) | 3.50 | 4.89 | 11.00 | 2.37 | 5.66 | 2.62 | 1.93 | 1.83 | 15+ |
| WMD-20RZ(T) | 3.50 | 4.69 | 10.62 | 2.37 | 5.30 | 2.62 | 1.93 | 1.56 | 1.52 |
| WMD-30R(T) | 3.50 | 4.70 | 11.87 | 2.37 | 5.45 | 2.62 | 1.93 | 1.89 | 1.22 |
| WMD-30RX(T) | 3.50 | 5.05 | 12.12 | 2.37 | 5.63 | 2.62 | 1.93 | 1.97 | 15+ |
| WMD-30RZ(T) | 3.50 | 4.66 | 11.25 | 2.37 | 4.78 | 2.62 | 1.93 | 1.56 | 1.52 |
| WMD-40R(T) | 4.38 | 4.75 | 11.00 | 3.12 | 6.74 | 3.37 | 2.09 | 1.89 | 1.22 |
| WMD-40RX(T) | 4.38 | 5.25 | 11.12 | 3.12 | 6.87 | 3.37 | 2.09 | 1.97 | 15+ |
| MD-55R(T) | 4.72 | 6.10 | 10.77 | 1.57 | 7.03 | 3.94 | 2.56 | 2.42 | 1.57 |
| MD-70R(T) | 5.63 | 6.09 | 10.20 | 2.75 | 5.71 | 4.25 | 2.56 | 2.09 | 1.69 |
| MD-70RZ(T) | 5.63 | 6.50 | 9.72 | 2.75 | 5.24 | 4.25 | 2.56 | 1.65 | 1.87 |
| MD-100R(T) | 6.14 | 6.88 | 12.67 | 2.76 | 6.37 | 4.33 | 2.95 | 2.55 | 1.70 |
| WMD-100R(T) | 6.60 | 6.80 | * | 3.00 | 12.05 | 4.88 | 3.50 | 2.55 | 1.71 |

* Varies with motor + Degrees offset from vertical

MD 6/10

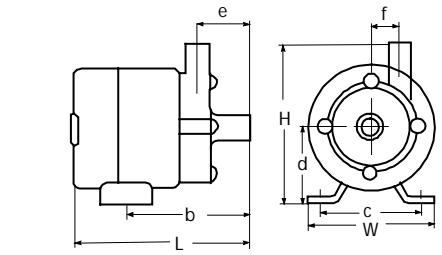

(W)MD 15/20/30/40/100

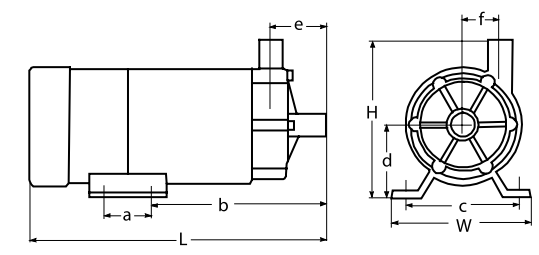

MD 55/70/100

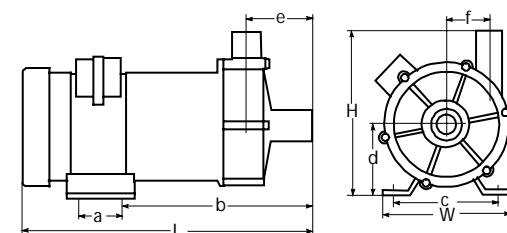

(W)MD-F 30/55/100

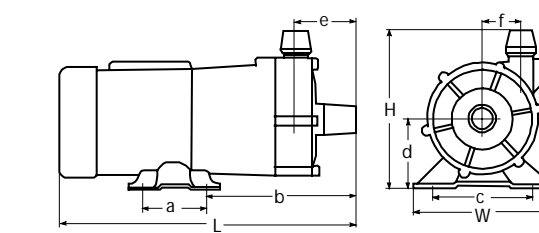

Dimensions (Fluoroplastic) – units in inches

| Model | W | H | L | a | b | c | d | e | f |
|----------------|------|------|-------|------|-------|------|------|------|------|
| WMD-30F(X,Y,Z) | 3.50 | 5.02 | 11.82 | 2.37 | 6.67 | 2.62 | 2.29 | 1.84 | 1.22 |
| MD-55F(Y,Z) | 4.72 | 6.11 | 10.63 | 1.57 | 7.81 | 3.94 | 2.56 | 2.30 | 1.56 |
| WMD-100F(Y,Z) | 6.60 | 6.80 | * | 3.00 | 12.05 | 4.88 | 3.56 | 2.55 | 1.71 |
| MD-100F(Y,Z) | 6.14 | 6.86 | 12.60 | 2.76 | 7.68 | 4.33 | 2.95 | 2.48 | 1.69 |

* Varies with motor