



MPVN

HIGH PRESSURE MULTI-STAGE PUMPS

A FULL RANGE OF PRODUCT FEATURES



The MPVN is manufactured for Goulds Water Technology by Austria GmbH, formally called Vogel Pumpen, at their plant near Vienna, Austria.

Performance Range:

Capacities up to 1500 GPM (340 m³/h)
Head up to 1640 feet (500 m)
Maximum speed up to 3600 RPM

Sizes:

From 1½" to 5" discharge.

Maximum Temperature:

280° F (140° C)

Maximum Casing Pressure:

800 psig (55 bar)

Handled Liquids:

Pure as well as slightly contaminated media such as:
Cold and Hot Water
Condensate
Oil Suspensions
Acids as well as their watery solutions

Applications:

Water Supply
Booster Systems
Irrigation
Fire Fighting
Snow Making
Cooling Circuits
Boiler Feed
Condensate
District Heating
Reverse Osmosis and Ultra Filtration
Spray Water Systems
Cleaning Systems

Modular System:

VOGEL Vertical Multistage pumps utilize a modular design concept which maximizes component interchangeability. As such, multiple design configurations can be engineered to meet customer requirements without compromise to repair part inventories. The entire performance range is covered by 4 mechanical sizes that hold 8 different hydraulics.

Hydraulics:

Closed radial type impellers designed for casing wear rings on both sides. Axial thrust is minimized by balance holes for minimum bearing loads and maximum bearing lifetime. Diffusers separated from stage casings, easily exchangeable. Balanced radial forces, minimum shaft deflection, minimum vibrations.

HEAVY DUTY DESIGN FOR LONG-TERM OPERATION IN INDUSTRIAL APPLICATIONS.

MPVN LIQUID END NUMBERING SYSTEM

MPV 2 03 B 3 A D 1 A

Flange Orientation:

- A = Left Suction, Left Discharge (code OO)
- B = Left Suction, Rear Discharge (code OR)
- C = Left Suction, Front Discharge (code OL)
- D = Left Suction, Right Discharge (code OG)

Seal Materials: For Optional Mechanical Seal modify catalog order no. with Seal Code listed below.

Seal Code	Rotary	Stationary	Elastomers
1	Carbide	Sil-Carbide	EPR
2			Viton

Motor Frames:

- | | | |
|-------------------|-------------------|-------------------|
| D = 254TD/256TD | J = 364TSD/365TSD | O = 444TD/445TD |
| E = 284TSD/286TSD | K = 364TD/365TD | P = 447TSD/449TSD |
| F = 284TD/286TD | L = 404TSD/405TSD | R = 447TD/449TD |
| G = 324TSD/326TSD | M = 404TD/405TD | S = 5009SD |
| H = 324TD/326TD | N = 444TSD/445TSD | |

Pump Material:

- | | |
|-------------------|----------------------|
| A = All Iron | C = Stainless Fitted |
| B = Bronze Fitted | D = All Stainless |

Seal Type:

- | | |
|---------------------|-------------------|
| 2 = SA - Unbalanced | 3 = SB - Balanced |
|---------------------|-------------------|

ANSI Discharge Flange Class:

- A = 150
- B = 300
- C = 600

Number of Stages

Pump Size:

- | | | |
|----------|-----------|-----------|
| 1 = 40.1 | 4 = 65.1 | 7 = 100.2 |
| 2 = 40.2 | 5 = 65.2 | 8 = 125.1 |
| 3 = 40.3 | 6 = 100.1 | 9 = 125.2 |

Pump Model

Complete Pump Consists of: Liquid End, Coupling and Motor.

MPVN SECTIONAL ASSEMBLY

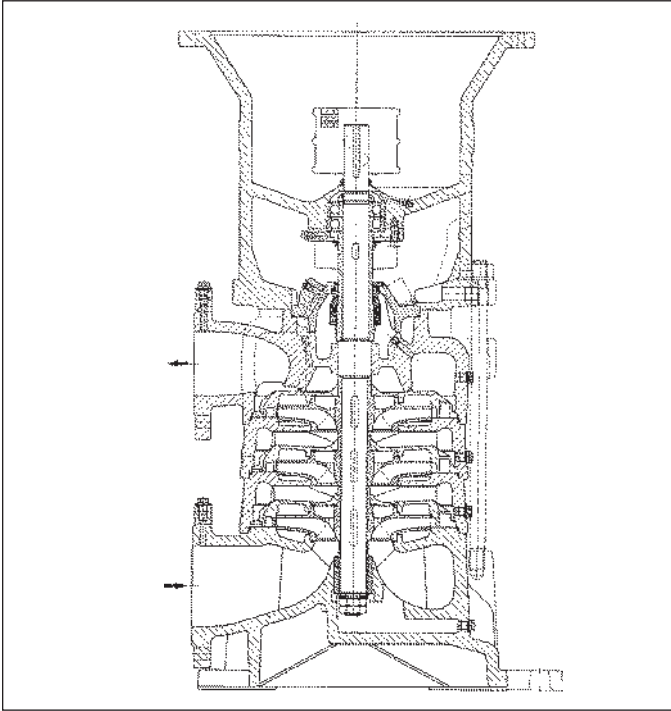

Type MPVN:

- Vertical configuration with separate thrust bearing, grease lubrication with grease nipples.
- Standard motor according to NEMA MG1-4.07, D flange mounting.
- Flexible coupling between pump and motor.
- Product lubricated sleeve bearing in suction casing.
- Maintenance friendly design. Shaft sealing maintainable without pump disassembly.

Shaft Seal Options:

Mechanical Seal:

Seal chamber dimensions-comply with ISO 3096. Mechanical seals of all brands that comply with this standard and EN 12756, version "K" can be used without modification of the standard parts.

The taper bore type seal chamber is self venting and guarantees optimum lubrication and cooling of the seal faces.

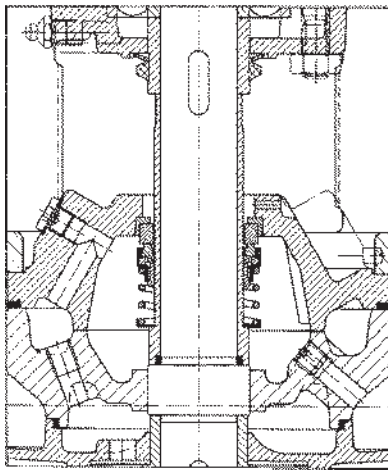

Single mechanical seal, design SA
unbalanced up to a maximum of 250 PSI (16 bar)

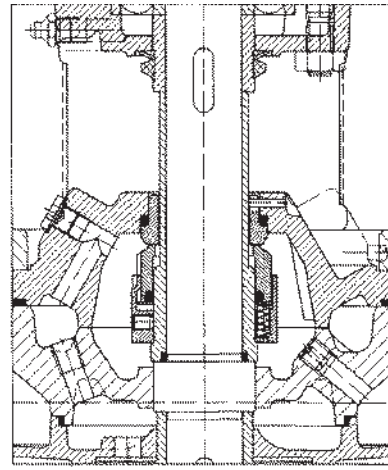

Single mechanical seal, design SB
balanced up to a maximum of 800 PSI (55 bar)

MPVN PARTS INDEX

Table of Materials

Pos.	Index of Part	Material Code			
		111	211	311	532
		Cast Iron	Bronze Fitted	Stainless Fitted	All Stainless
1	Impeller	0.6025	2.1050.01	1.4408	1.4408
2, 2/E	Diffuser	0.6025	0.6025	0.6025	1.4408
3	Suction casing	0.6025	0.6025	0.6025	1.4408
4	Discharge casing	0.6025 (Class 600 -0.7040)	0.6025 (Class 600 -0.7040)	0.6025 (Class 600 -0.7040)	1.4408
9	Wear ring	1)	1)	1)	1.4408
8, 12	Bearing cover	0.6025	0.6025	0.6025	0.6025
18	Seal cover	0.6025	0.6025	0.6025	1.4408
21	Bearing bush	G-CuSn16	G-CuSn16	G-CuSn16	G-CuSn16
23, 2444	Shaft and shaft sleeves	1.4021	1.4021	1.4021	1.4462
60	Intermediate bearing housing, stage casing	0.6025	0.6025	0.6025	1.4408

1) Upon request of 1.4410 possible

Elastomers (O-Ring) of EPDM for hot water up to 284°F (140°C) (Pay attention to operation limits and chemical resistance), optional Viton elastomers available.

MPVN MATERIAL SPECIFICATION DIN-ASTM

Casted Material Standards	DIN Designation	DIN	ASTM	UNS
Cast Iron	EN GJL-250 (GG 25)	0.6025	A48 Class 30 (general castings)	F12401
			A278 Class 30 (press. castings)	
Ductile Iron	EN-GJS-400-18-LT	0.7043	A395 Grade 60-40-18	F32800
	EN-GJS-400-15 (GGG 40)	0.7040	A536 Grade 60-40-10②	-
Carbon Steel	GP 240 GH (GS-C25)	1.0619	A216 - WCB	J03002
Stainless Steel	1.4408	1.4408	A351 / A743 / A744 CF-8M③	J92900
	1.4410	1.4410	A789 / A790 Typ 2507①	S32750
Duplex SS	1.4517	1.4517	A351 CD4-MCu	
Bronze	G - CuSn 10 / CC480K	2.1050.01	B427④	C90700
Wrought Material Standards				
Stainless Steel	1.4021	1.4021	A276 Typ 420	S42000
Duplex SS	1.4462	1.4462	A276 Typ 2205	S31803
Fastener Materials (Bolts)				
Carbon Steel	DIN 267 Class 8.8	1.7225	A193 B7	J41400
Stainless Steel	A2	A2	A193 B8	S30400
Stainless Steel	A4	A2	A193 Grade B8M	S31600

① only used for casing wear rings

② less elongation

③ A351/A743 for general applications A744 for several services

④ also available B148/B584

COMPARISON OF VARIOUS STANDARDS

EN (DIN)		ISO	BSI (UK)	AISI	ASTM	UNS
0,6025	EN-GJL-250 (GG 25)	185/Gr. 250		1452 Gr. 220	A 278 Class 30	
0.7040	EN-GJS-400-15 (GGG 40)	1083/400-12			A 536 Gr. 60-40-18	
2.1050.01	G-CuSn10				B584 C 90700	
1.0421	X20Cr13	683-13-4	970 420 S 37	420	A 276 Type 420	
1.4408	G-X6CrNiMo 18-10		3100-316 C 16	CF8M	A (351) 744 Gr. CF8M	
1.4410	X2CrNiMoN25-7-4				A182/A479/2276	S32750
1.4462	X2CrNiMoN22-5-3		1503 318 S13		A240	S31803 S32205

MECHANICAL SEAL MATERIALS

DIN Code	Mechanical Seal	Stationary Ring	Elastics	Metal Parts
BQ 1 EGG	Carbon①	SiC②	EPDM	316TC
BQ 1 VGG			Viton	
Q1 Q1 VGG	SiC②			

① Carbon resin impregnated

② Pure silicon carbide (without free silicone)

SHAFT SEAL: MECHANICAL SEAL CODE . . .SA (UNBALANCED)

Sizes: MPVN40.2 through MPVN125.2

Part Number	Description
1	Impeller
2	Diffuser
2E	Diffuser, last stage
3	Suction casing
4	Discharge casing
8	Bearing pedestal
12	Bearing cover
18	Seal cover
21	Bearing bushing
23	Bearing sleeve
24	Shaft
25	Tie bolt
28	Impeller nut
29	Washer
44U	Shaft wearing sleeve
50	Bearing nut
60	Stage casing
69	Gland
72	Spacer sleeve
73M	Thrower
73P	Thrower
95	Shaft guard
D	Drain plug
DR	Throttling element
G	Grease nipple
GLRD1	Mechanical seal
K	Radial ball bearing
M1	Nut
M5	Nut
OR1	O-ring
OR2	O-ring
OR3	O-ring
OR4	O-ring
PM1	Pressure gauge
PM2	Pressure gauge
PF1	Key
PF2	Key
PF3	Key
PF4	Key
S4	Pin
S5	Stud
V1	Plug, threaded
V3	Plug, threaded
W1	Washer

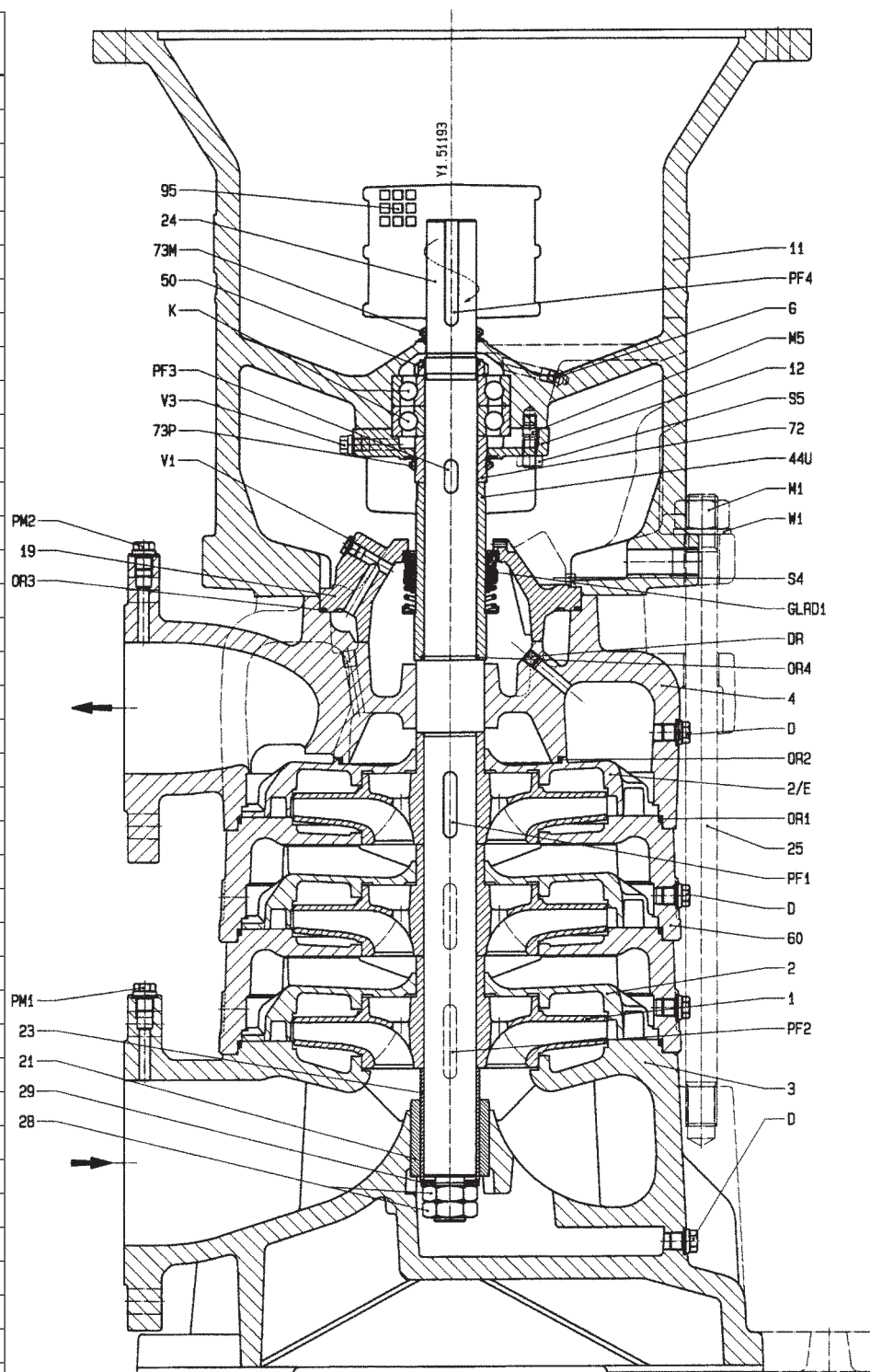

SHAFT SEAL: MECHANICAL SEAL CODE . . .SB, SD (BALANCED)

Sizes: MPVN40.2 through MPVN125.2

Part Number	Description
1	Impeller
2	Diffuser
2E	Diffuser, last stage
3	Suction casing
4	Discharge casing
8	Bearing pedestal
12	Bearing cover
18	Seal cover </td
21	Bearing bushing
23	Bearing sleeve
24	Shaft
25	Tie bolt
28	Impeller nut
29	Washer
44B	Shaft wearing sleeve
50	Bearing nut
60	Stage casing
69	Gland
72	Spacer sleeve
73M	Thrower
73P	Thrower
95	Shaft guard
D	Drain plug
DR	Throttling element
G	Grease nipple
GLRD1	Mechanical seal
K	Radial ball bearing
M1	Nut
M5	Nut
OR1	O-ring
OR2	O-ring
OR3	O-ring
OR4	O-ring
PM1	Pressure gauge
PM2	Pressure gauge
PF1	Key
PF2	Key
PF3	Key
PF4	Key
S4	Pin
S5	Stud
S7	Pin
V1	Plug, threaded
V3	Plug, threaded
W1	Washer

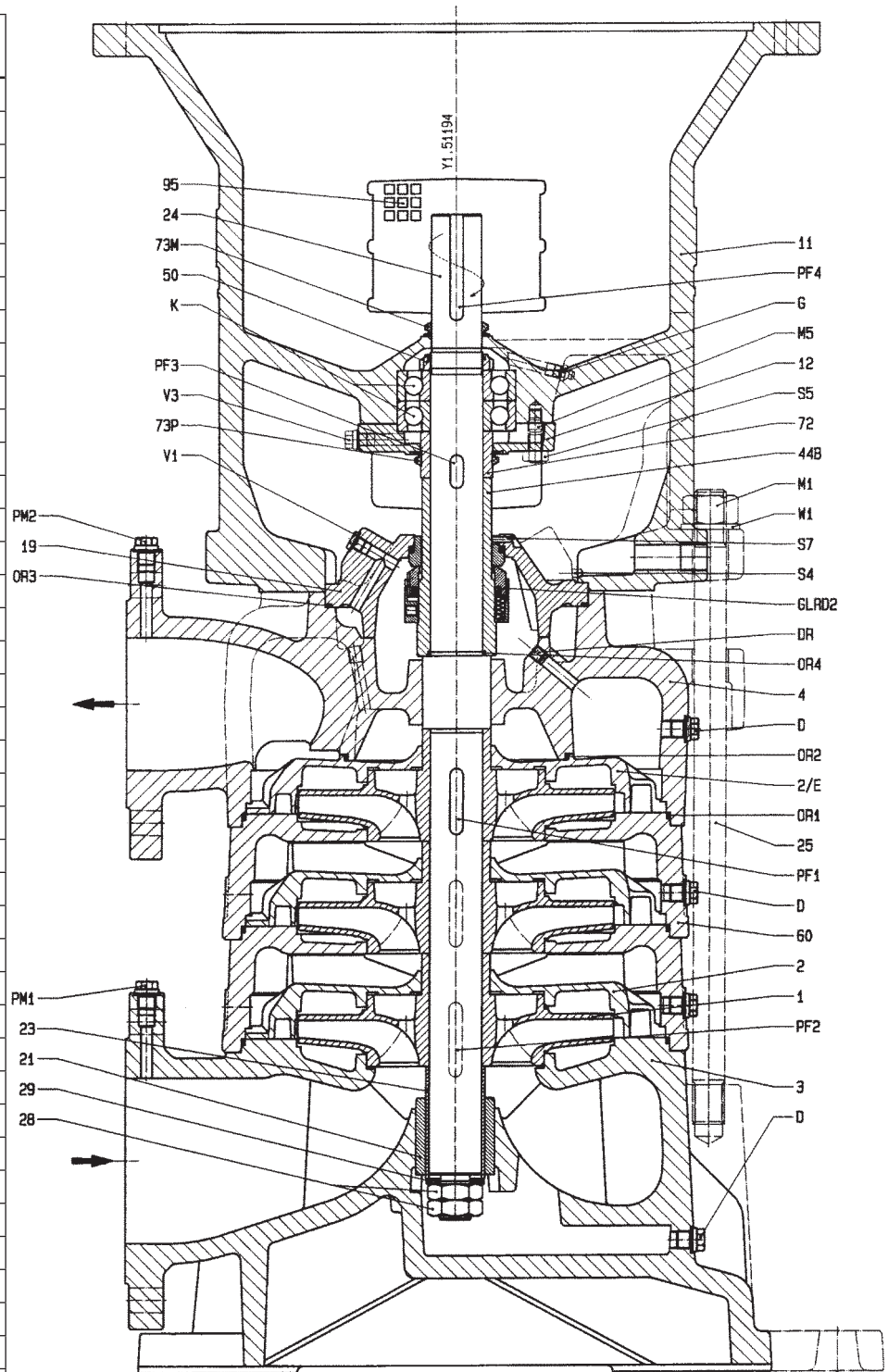

PRESSURE AND TEMPERATURE LIMITS

Maximum Allowed Operating Pressure (Casing and Flanges): Material Code 111 (Cast Iron), 211 (Bronze Fitted), 311 (SS Fitted)

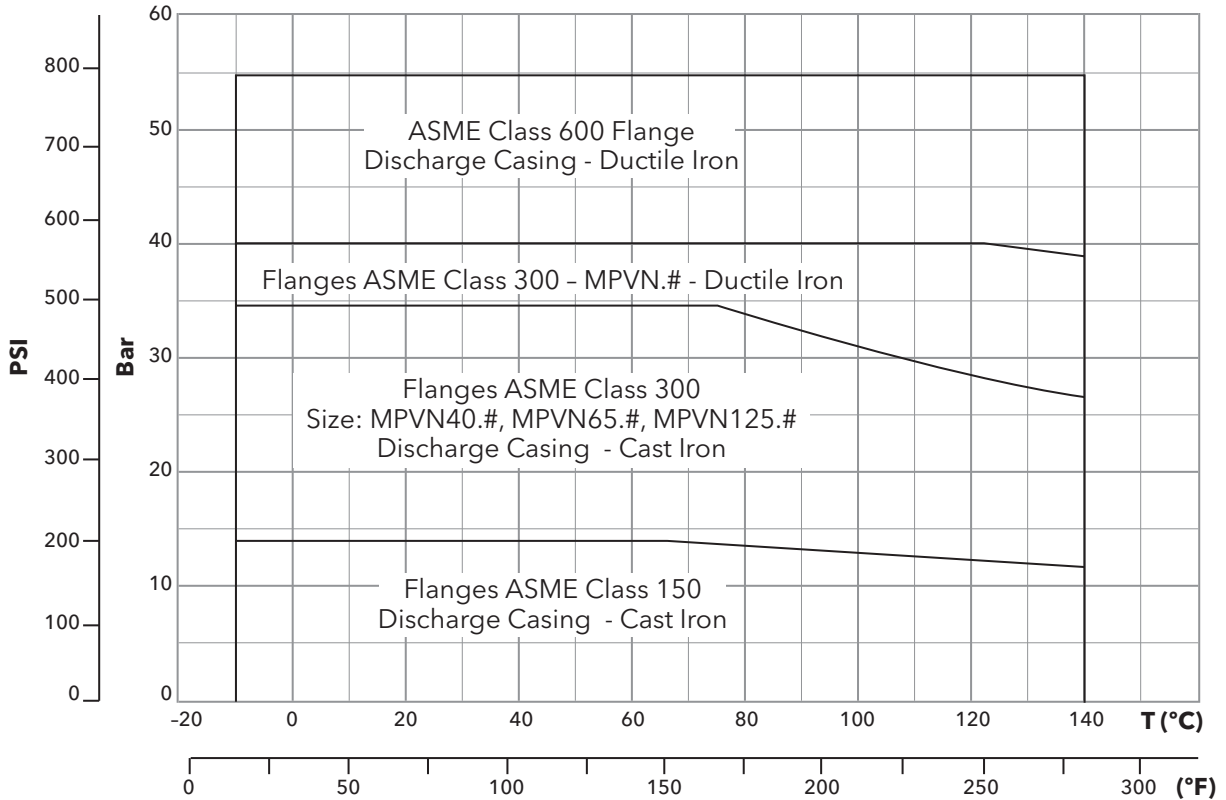

Maximum Allowed Operating Pressure (Casing and Flanges): Material Code 532 (All Stainless)

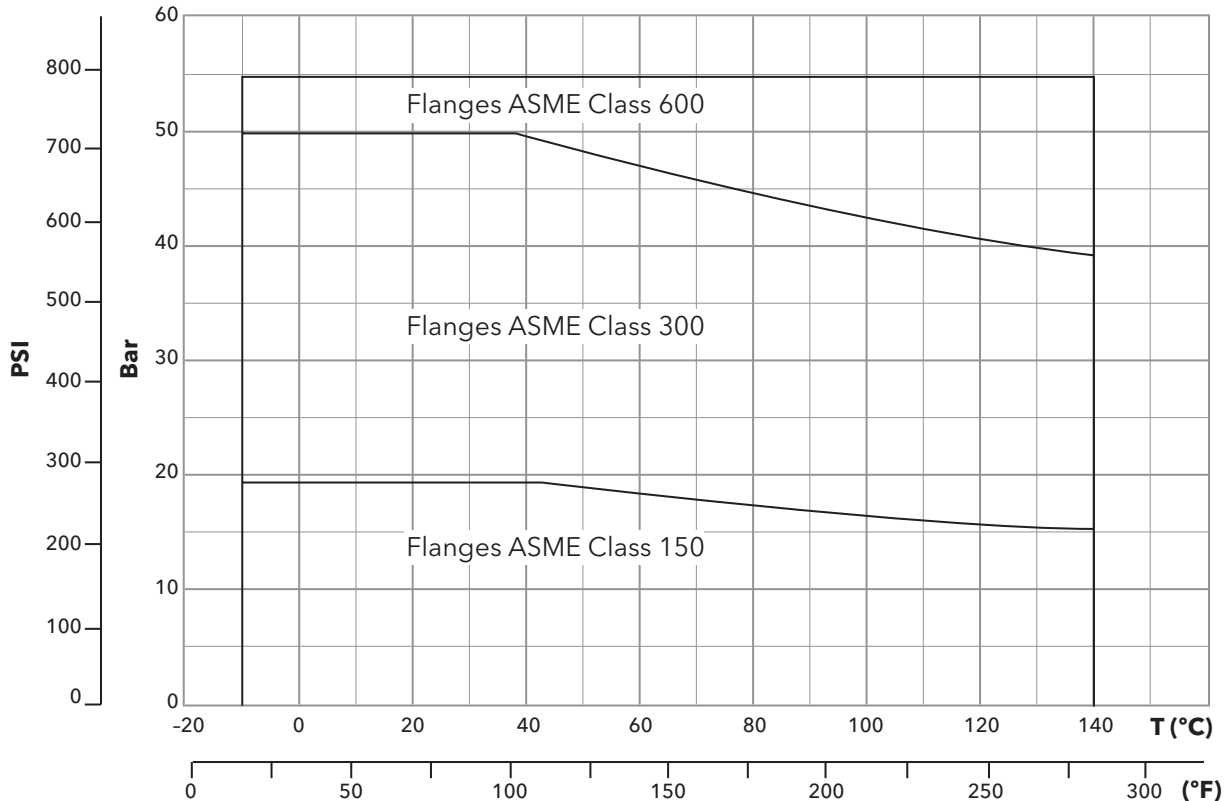

Maximum Allowed Operating Pressure = incoming pressure at suction flange and pump head at 0 flow.

SELECTION CHARTS FOR SHAFT SEALING WITH MECHANICAL SEAL

Sealing Code of Mechanical Seal:

Discharge Side	Code
IV	SA
V	SB
VI	SD*

* upon request

General:

Area IV: Mechanical seal acc. DIN 24960, U-shape with L1k, Material: carbon - SiC - EP

Area V: Mechanical seal acc. DIN 24960, B-shape with L1K, Material: carbon - SiC - EP

Area VI: Mechanical seal acc. DIN 24960, B-shape with L1k, Material: carbon - tungstencarbide - EP

Selection charts are only valid for clean water resp. demineralized boiler feed water. For SiO₂ (silicic acid) contents > 4 mg/l resp. SiO₂ containing water treatment liquids, please ask manufacturer.

Clean liquids, solids < 10 mg/l

Minimum pressure at suction flange at temperatures > 176°F (80°C) needs to be available.

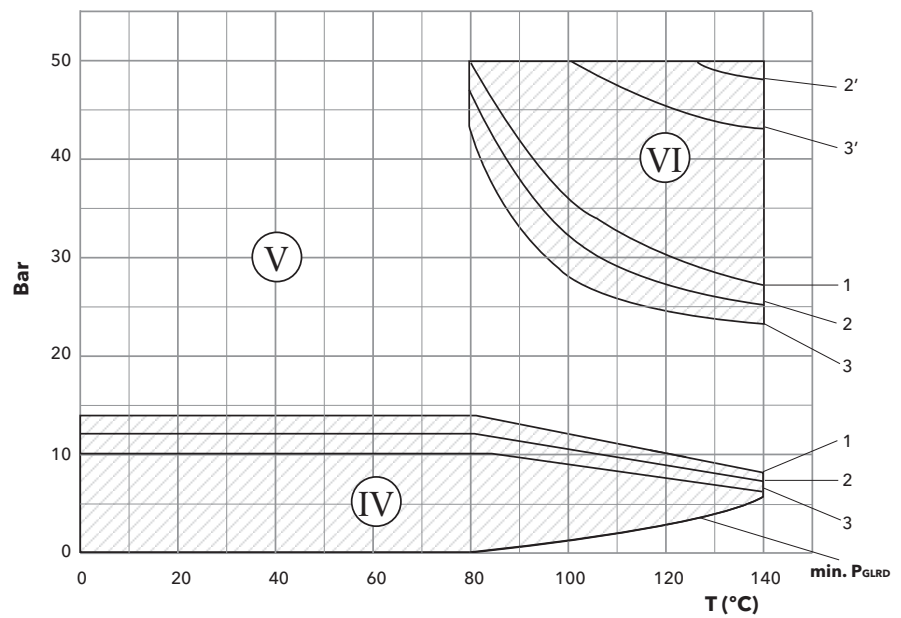

MPVN PERFORMANCE RANGE - 60 HZ

3550 RPM

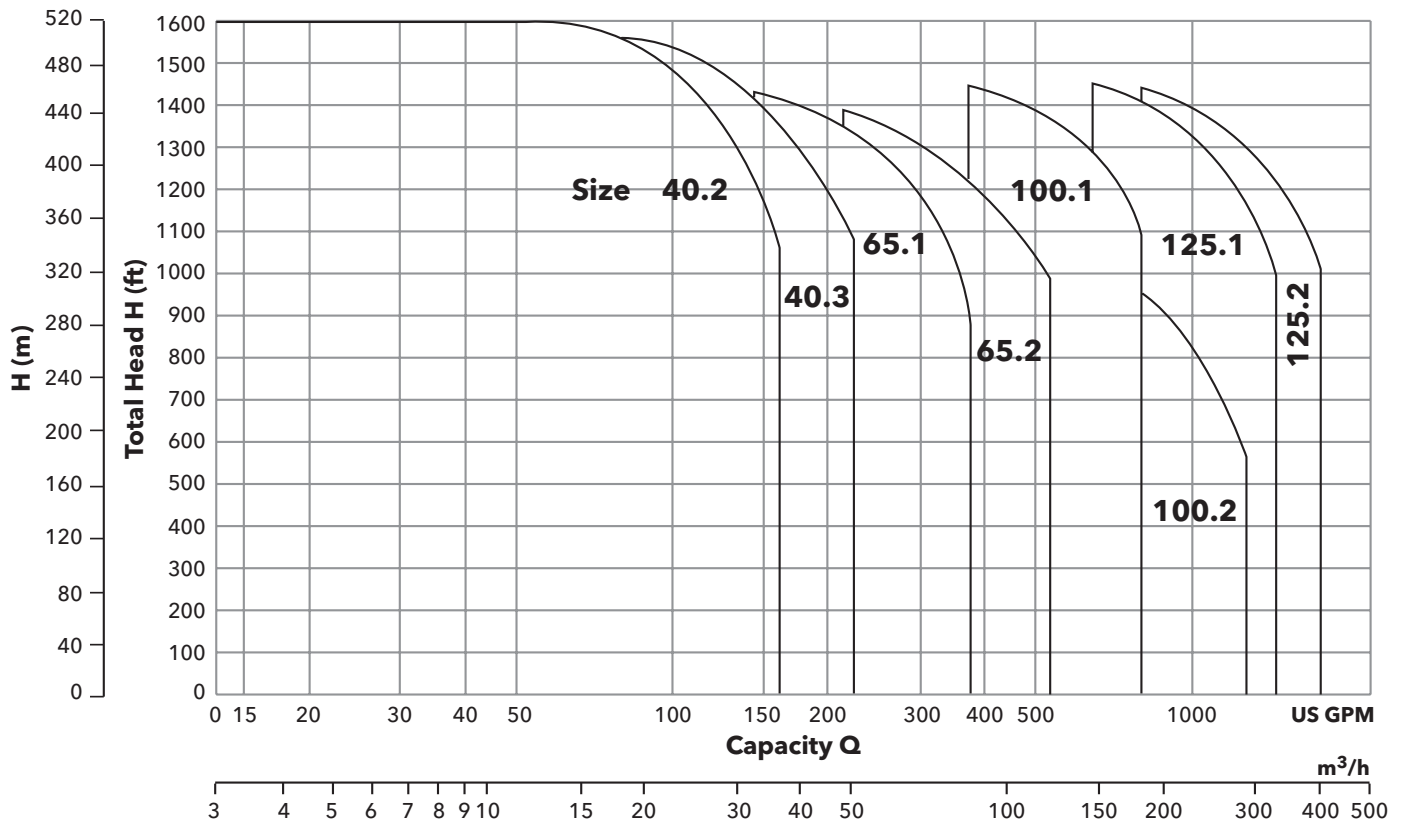

1750 RPM

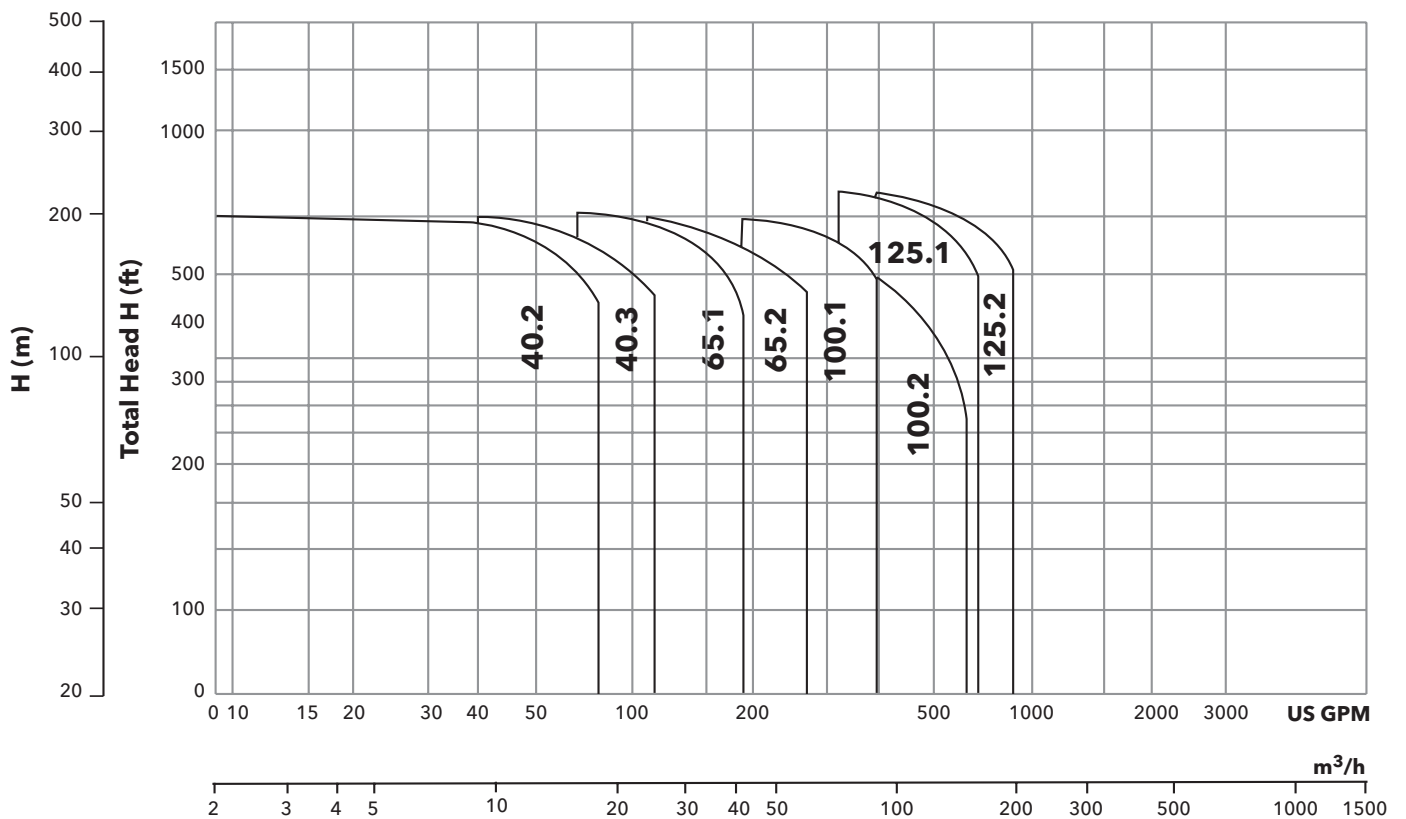

MPVN SELECTION CHARTS

Single Stage

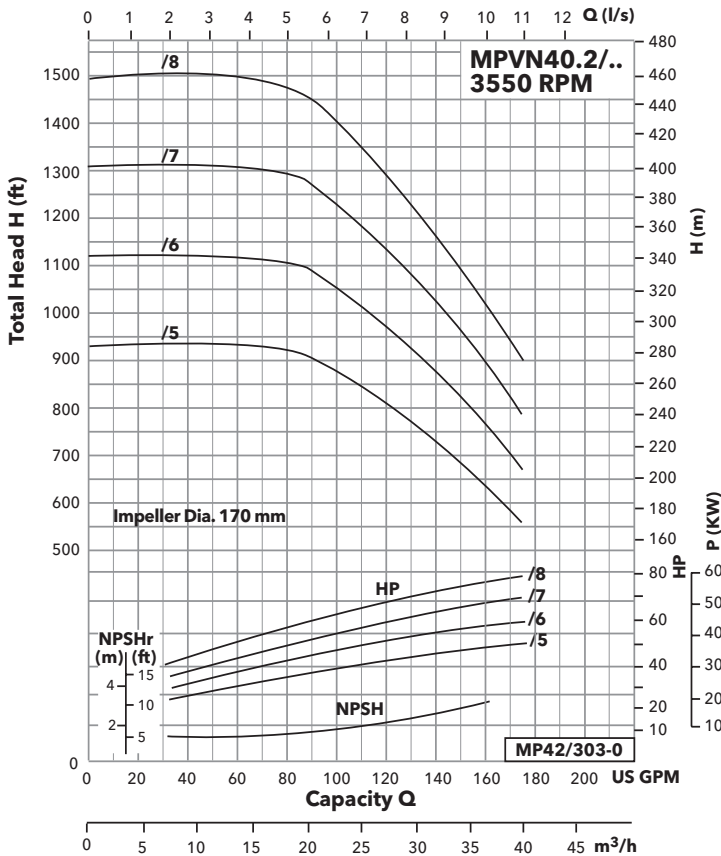
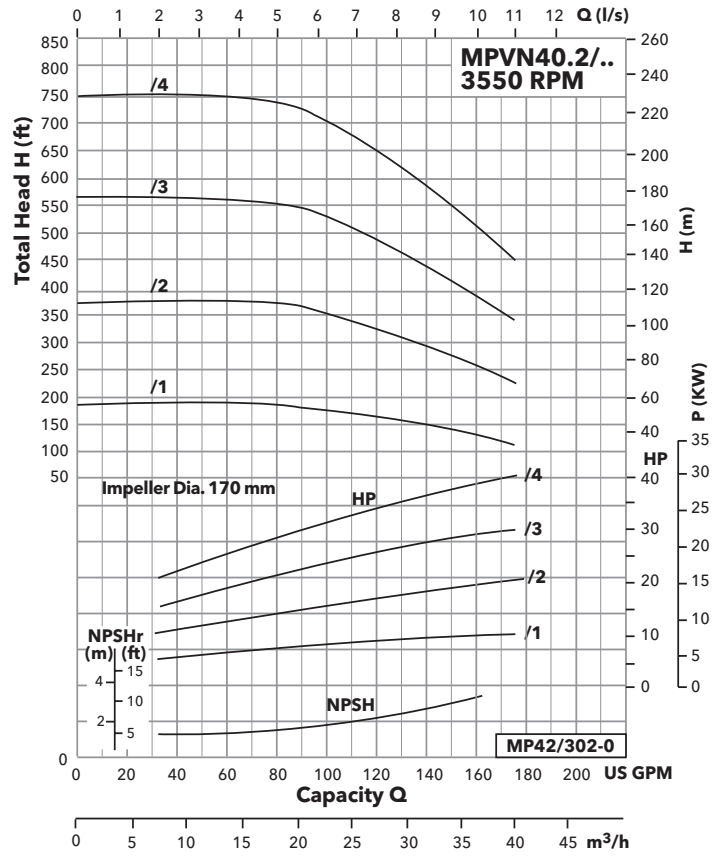
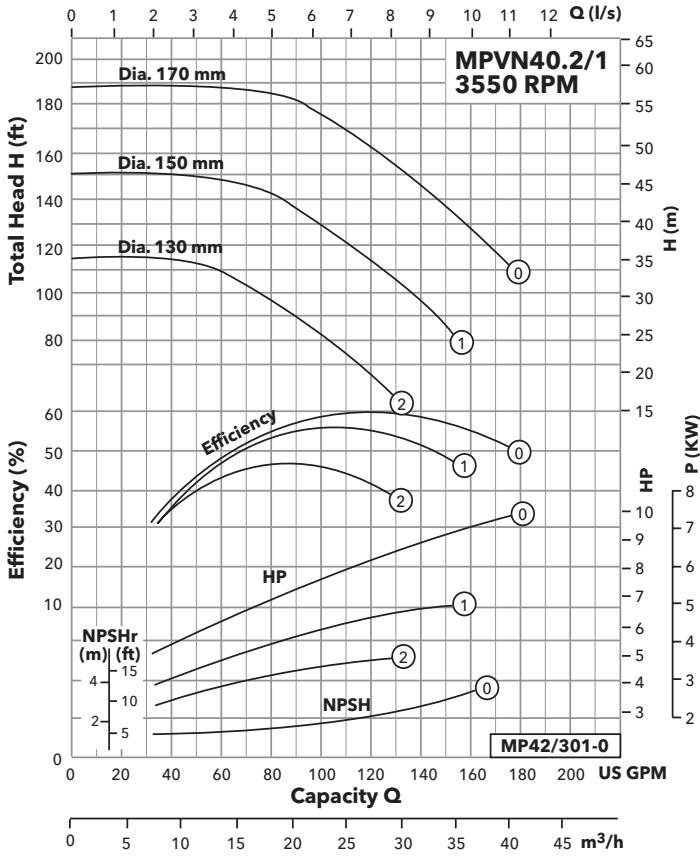

MPVN SELECTION CHARTS

Single Stage

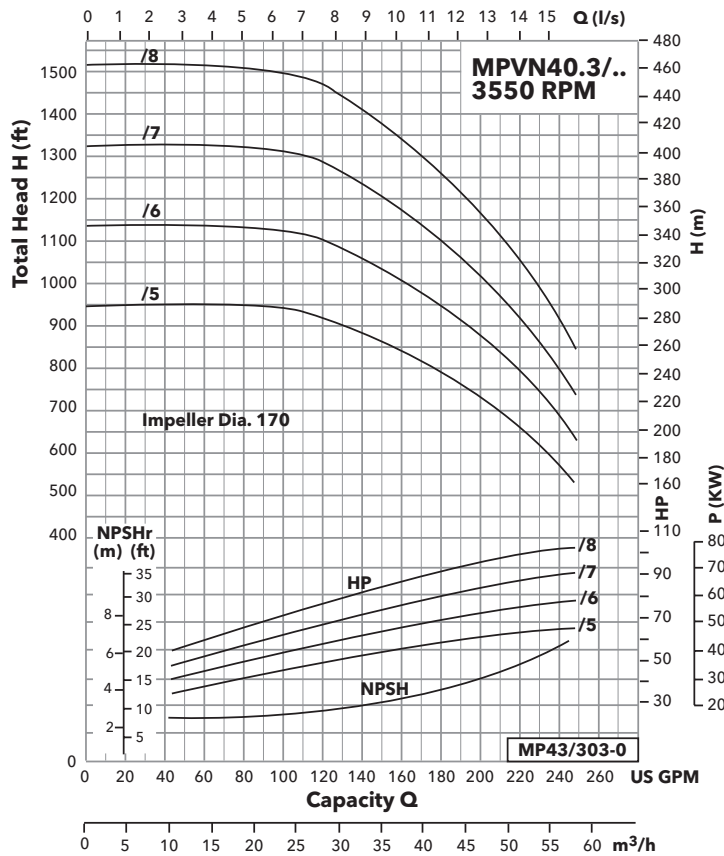
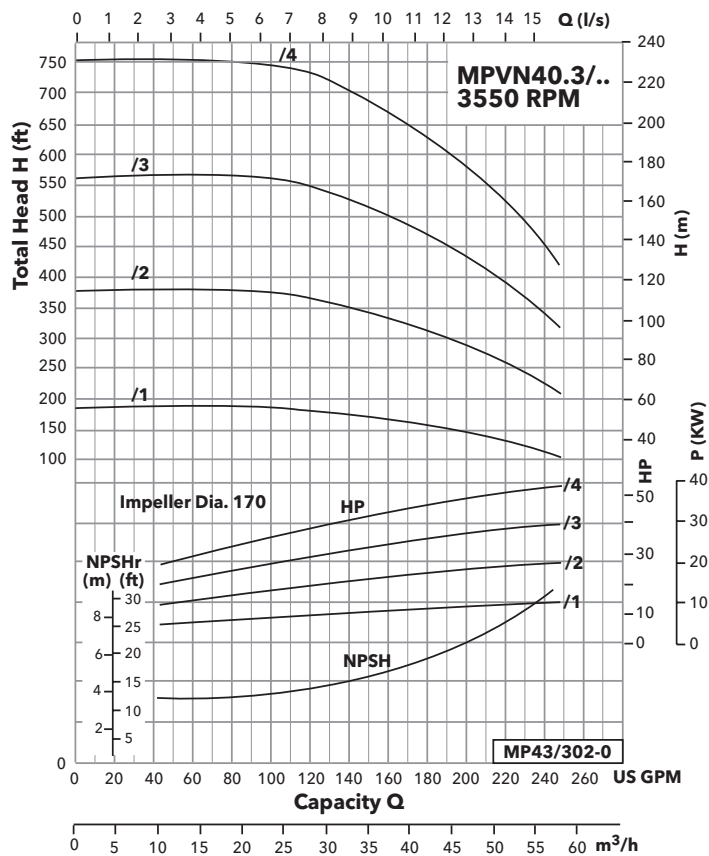
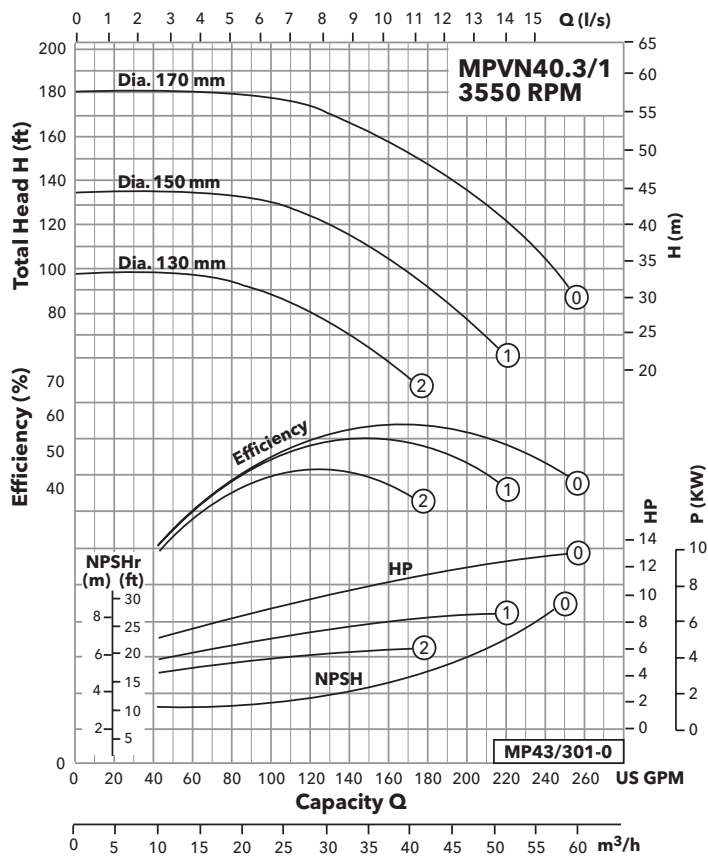

SELECTION CHARTS: MPVN 40.2 n = 1750 RPM

Single Stage

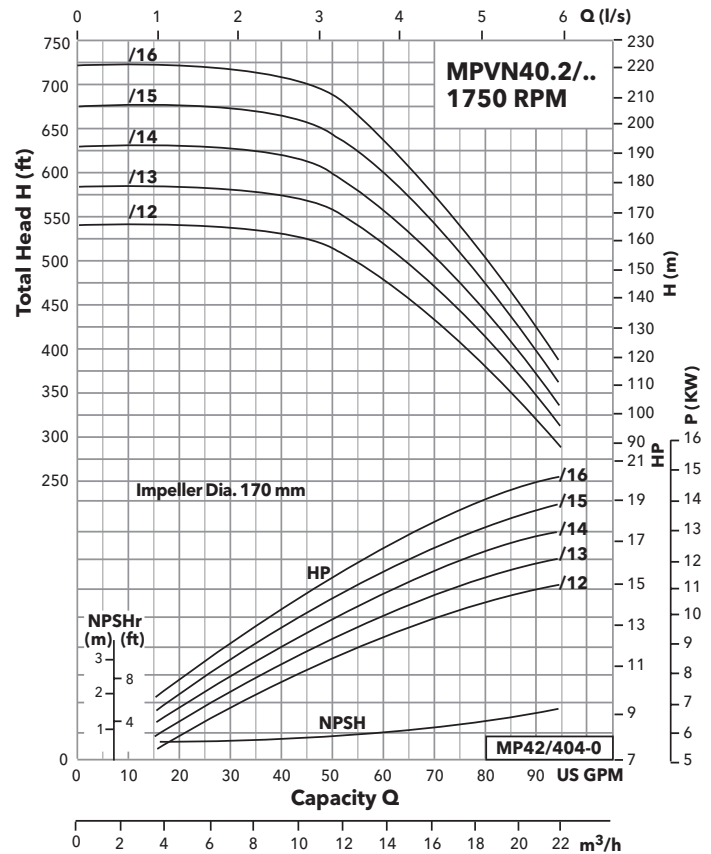
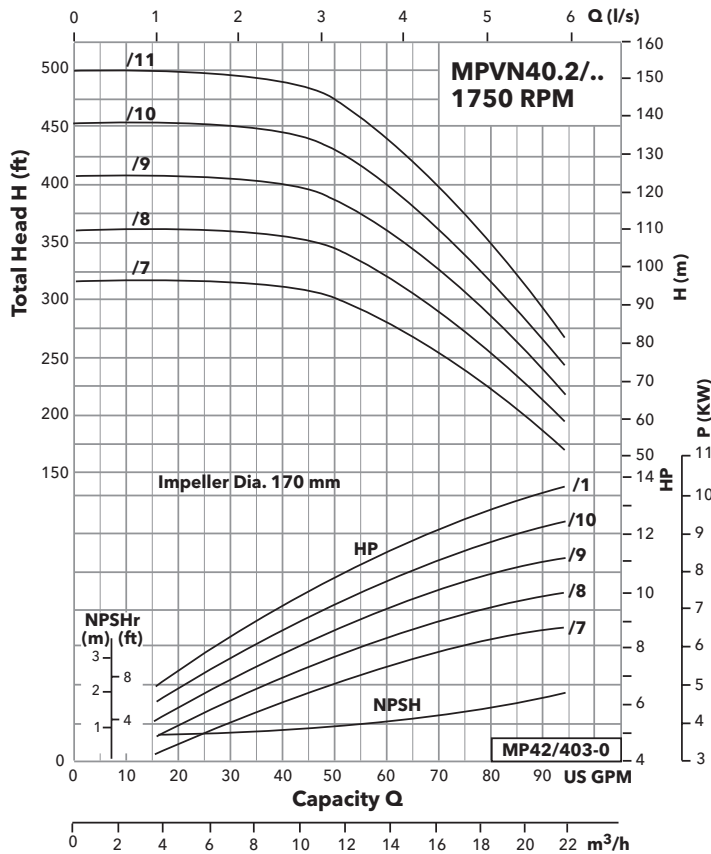
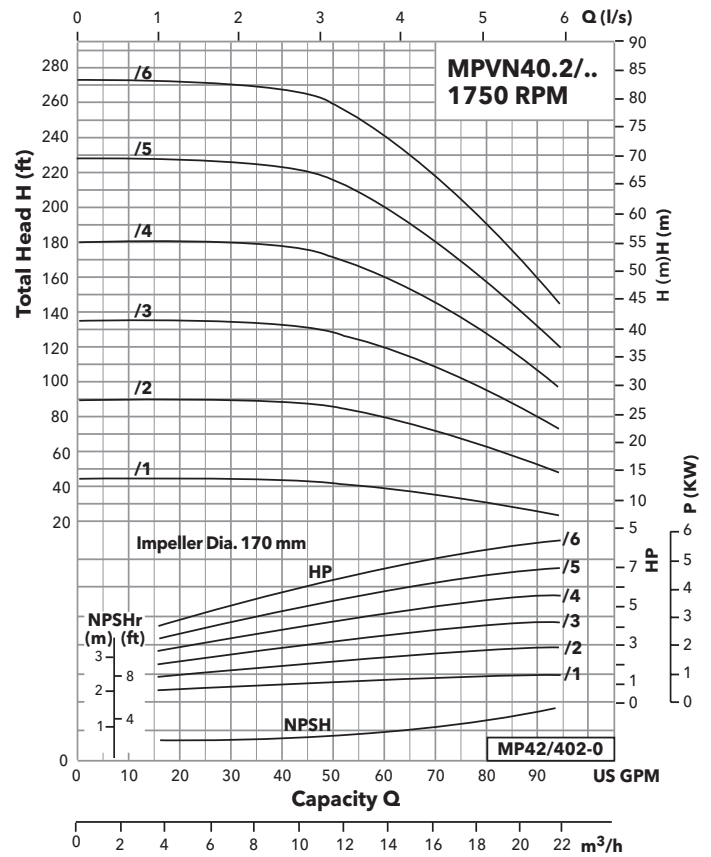
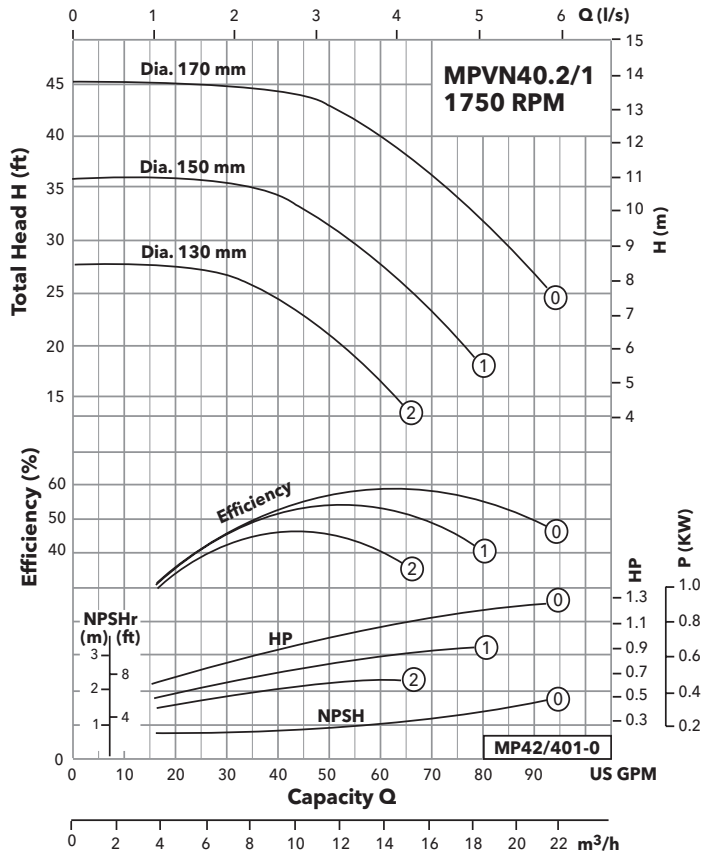

SELECTION CHARTS: MPVN 40.3 n = 1750 RPM

Single Stage

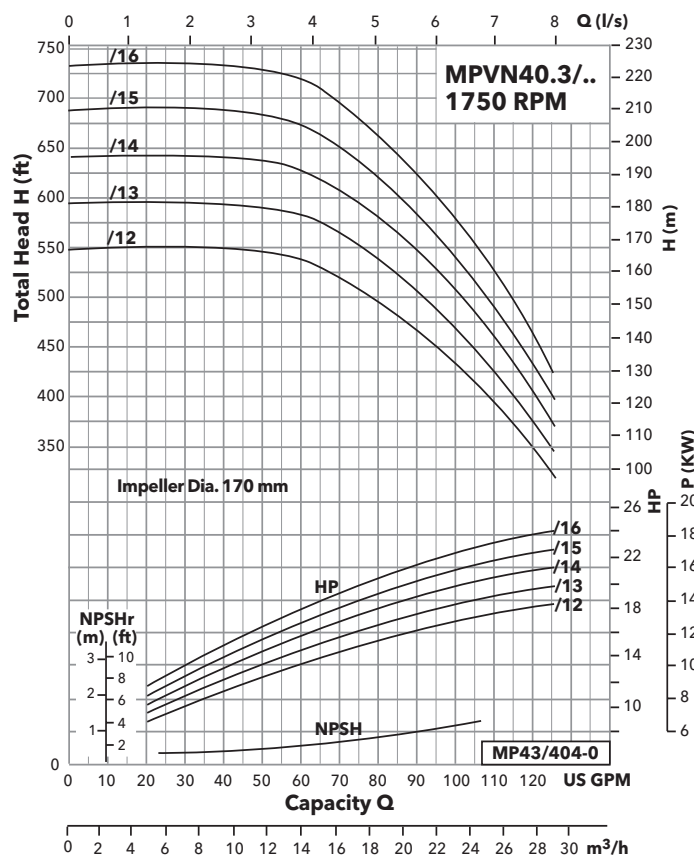
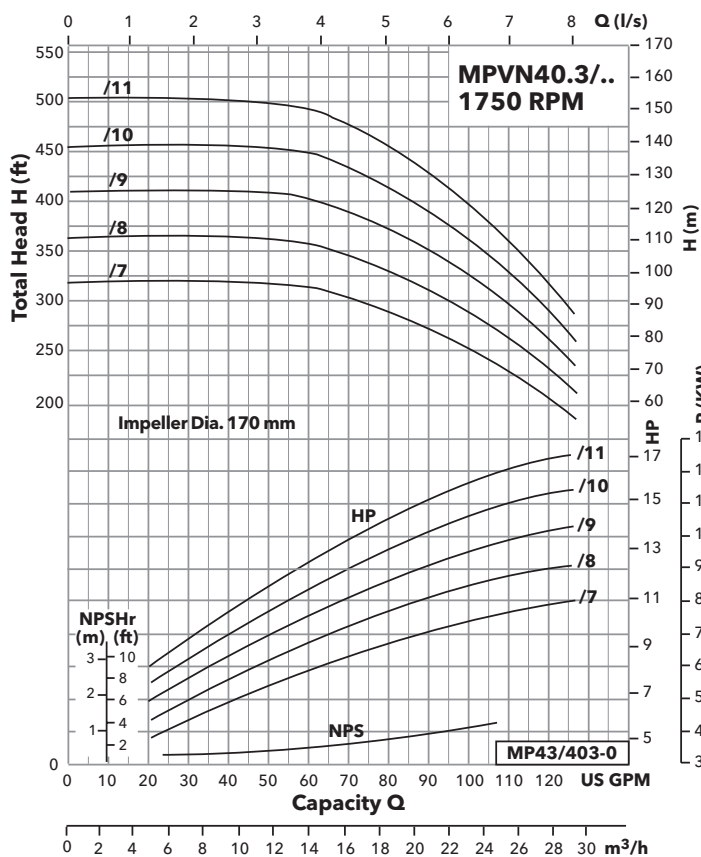
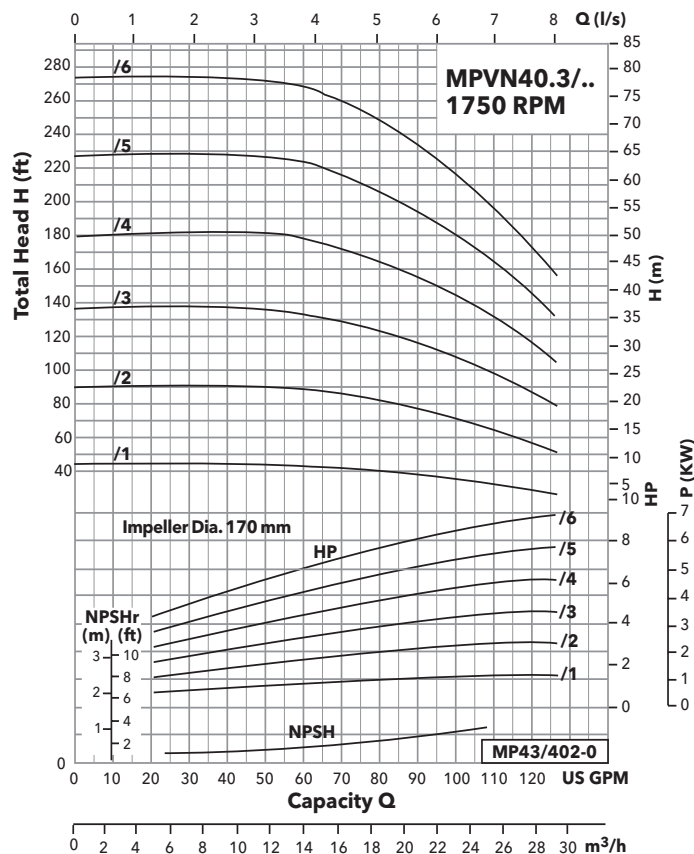
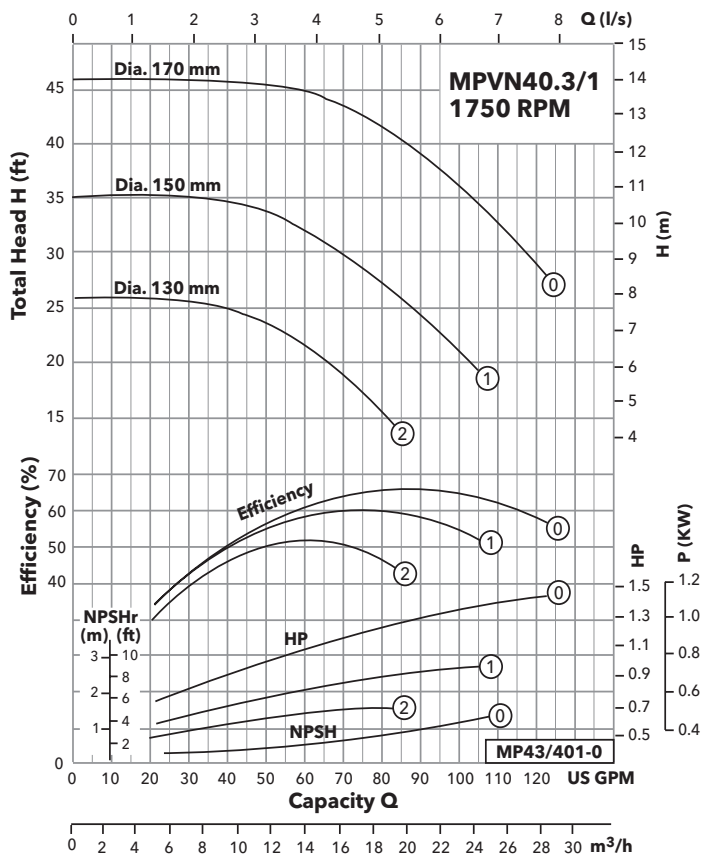

MPVN STANDARD CONSTRUCTION MPVN40.2, MPVN40.3

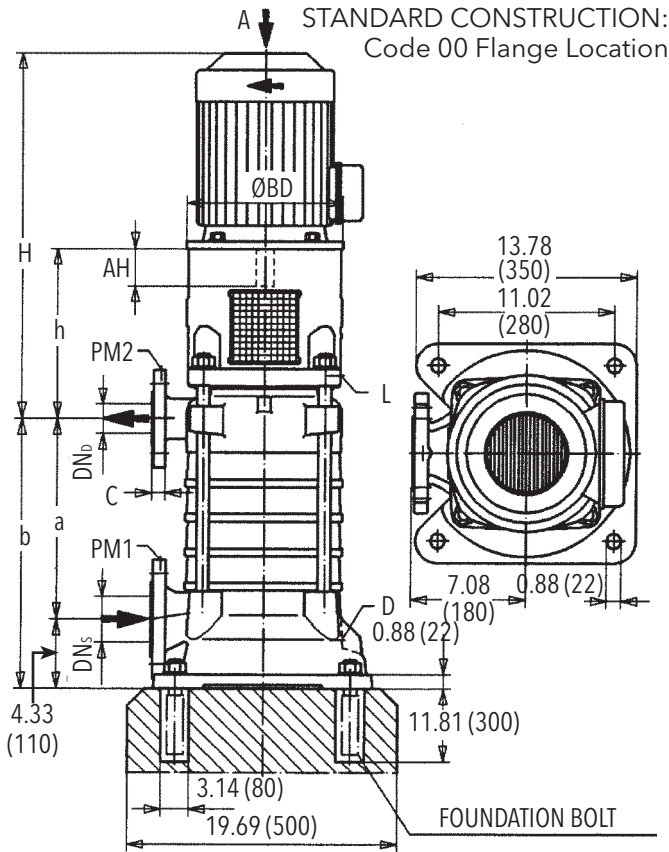

Number of Stages

	1*)	2*)	3	4	5	6	7	8	9
a	3.94 (100)	6.10 (155)	8.27 (210)	10.43 (265)	12.60 (320)	14.76 (375)	16.93 (430)	19.09 (485)	21.26 (540)
b	8.27 (210)	10.43 (265)	12.60 (320)	14.76 (375)	16.93 (430)	19.09 (485)	21.26 (540)	23.43 (595)	25.59 (650)
	10	11	12	13	14	15	16		
a	23.43 (595)	25.59 (650)	27.76 (705)	29.92 (760)	32.09 (815)	34.25 (870)	36.42 (925)		
b	27.76 (705)	29.92 (760)	32.09 (815)	34.25 (870)	36.42 (925)	38.58 (980)	40.75 (1035)		

NEMA Motor	HP (rpm)		h	H	BD	AH
	3550	1750				
254TD	15	15	15.51 (394)	34.69 (881)	14.02 (356)	4.00 (101.6)
256TD	20	20	15.51 (394)	34.69 (881)	14.02 (356)	4.00 (101.6)
284TD	-	25	15.51 (394)	37.44 (881)	14.02 (356)	4.62 (117.3)
284TSD	25	-	15.51 (394)	37.44 (881)	14.02 (356)	3.25 (82.5)
286TD	-	30	15.51 (394)	37.44 (881)	14.02 (356)	4.62 (117.3)
286TSD	30	-	15.51 (394)	37.44 (881)	14.02 (356)	3.25 (82.5)
324TSD	40	-	15.51 (394)	38.43 (976)	17.95 (456)	3.75 (95.3)
326TSD	50	-	15.51 (394)	38.43 (976)	17.99 (457)	3.75 (95.3)
364TSD	60	-	15.51 (394)	39.33 (999)	17.99 (457)	3.75 (95.3)
365TSD	75	-	15.51 (394)	39.33 (999)	17.99 (457)	3.75 (95.3)
405TSD	100	-	16.69 (424)	43.43 (1103)	22.01 (559)	4.25 (108.0)

ALTERNATIVE FLANGE LOCATIONS

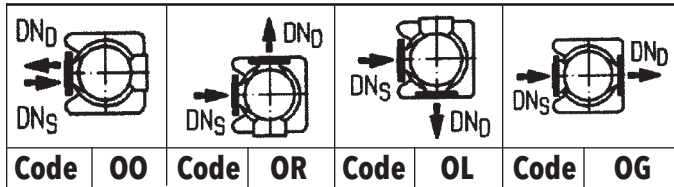

PUMP FLANGES

ASME B16.5							
DN	Class	D	K	C	d	L	No. of Holes
Discharge 1½ (in.)	150	6.14 (156)	3.86 (98)	0.87 (22)	2.87 (73)	5/8 (16)	4
	300	6.14 (156)	4.49 (114)	0.87 (22)	2.87 (73)	7/8 (22)	4
	600	7.01 (178)	4.49 (114)	1.10 (28)	2.87 (73)	5/8 (16)	4
Suction 2½ (in.)	150	7.52 (191)	5.51 (140)	0.94 (24)	4.13 (105)	¾ (19)	4
	300	7.52 (191)	5.87 (149)	0.94 (24)	4.13 (105)	7/8 (22)	8

PM1 = Suction Gauge Conn. G1/4
 PM2 = Discharge Gauge Conn. G1/4
 L = Vent Conn. G1/2
 D = Drain Conn. G1/4
 *) = Code OO not possible, normal configuration code OG
 Dimensions in inches (mm).

Dimensions in inches (mm)

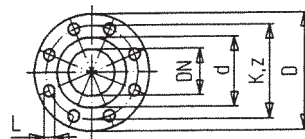

SELECTION CHARTS MPVN 65.1 n = 3550 rpm

Single Stage

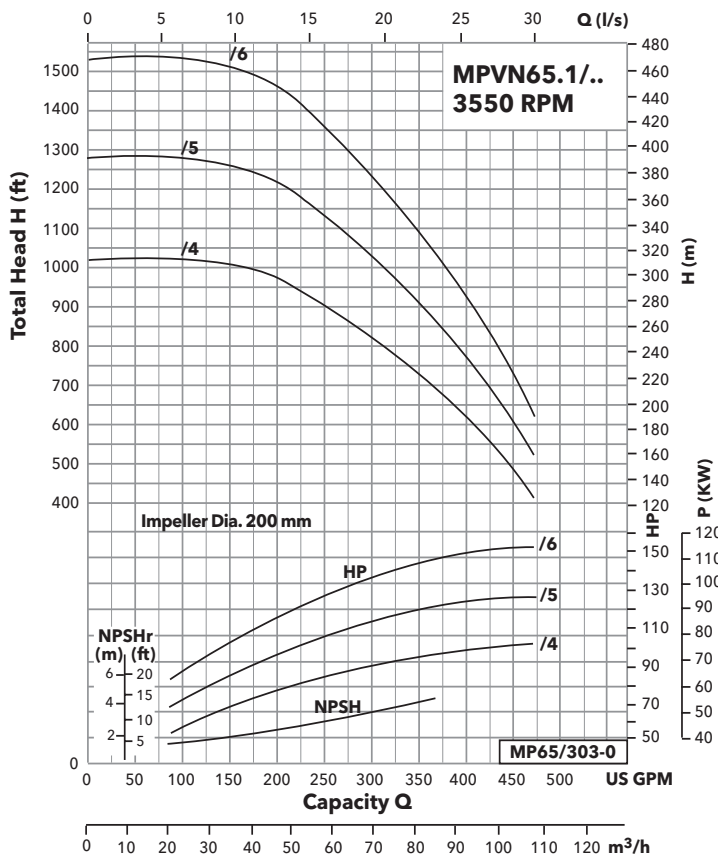
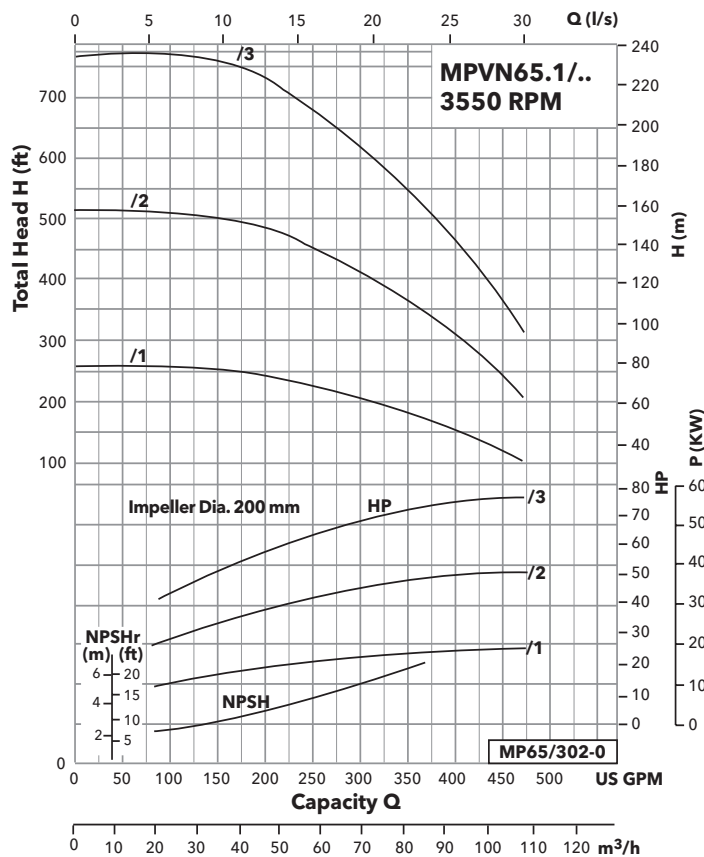
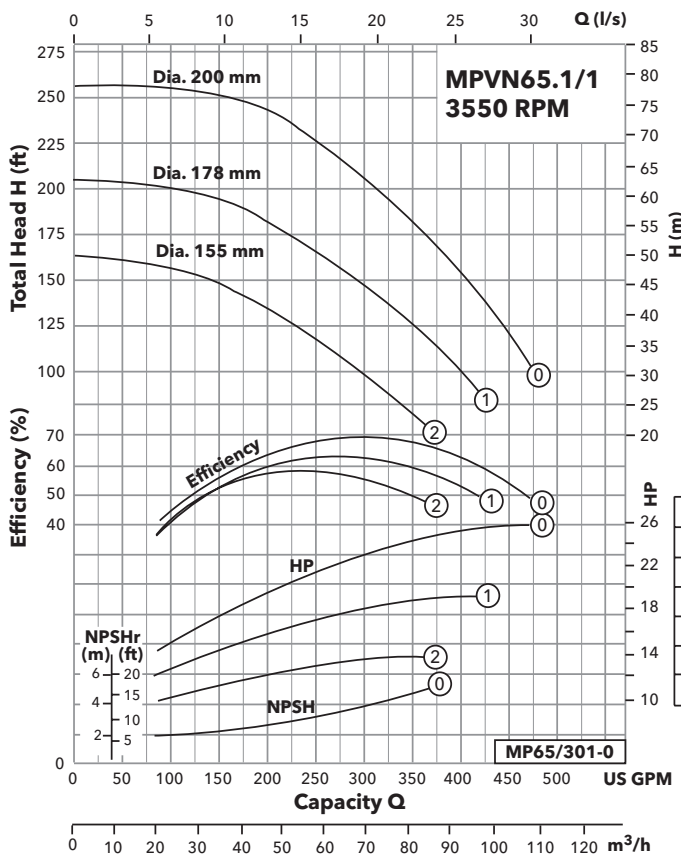

SELECTION CHARTS MPVN 65.2 n = 3550 RPM

Single Stage

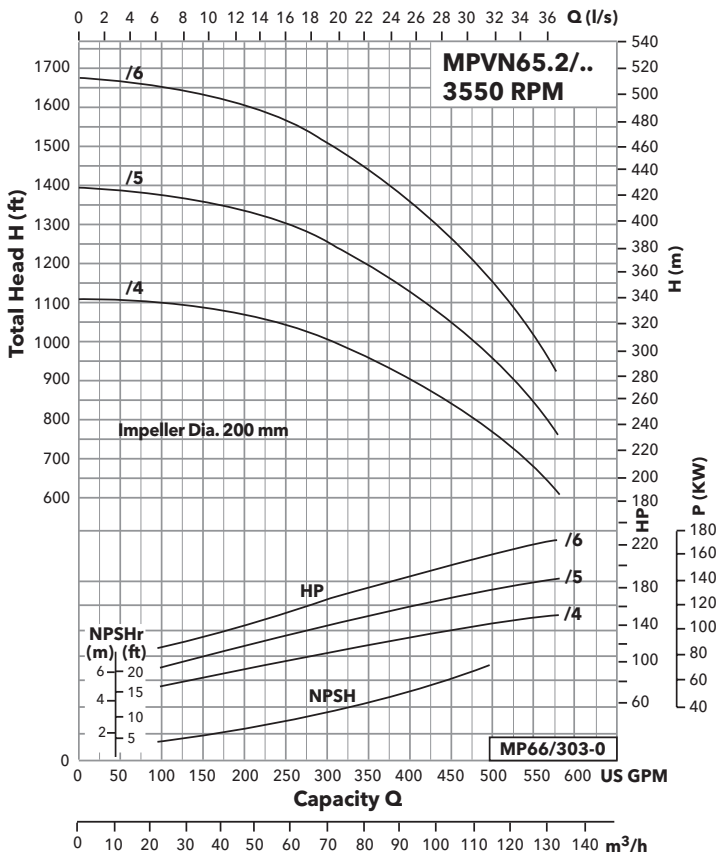
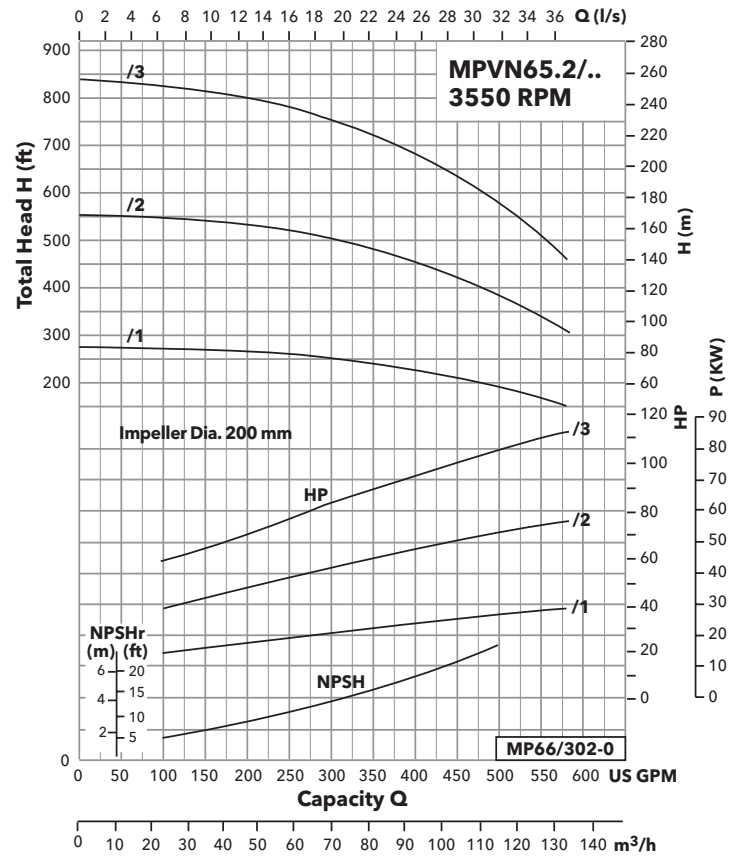
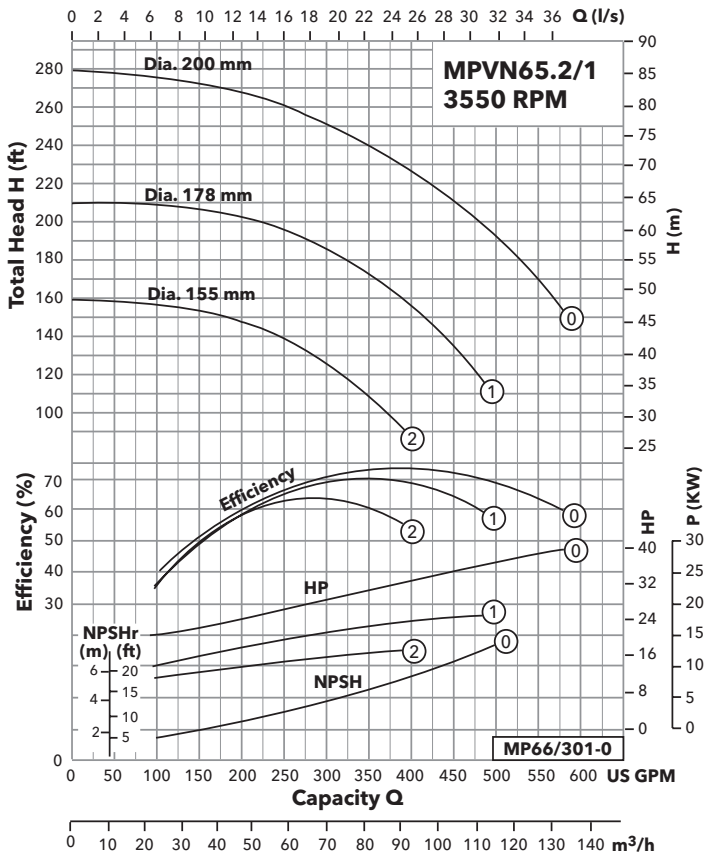

SELECTION CHARTS MPVN 65.1 n = 1750 RPM

Single Stage

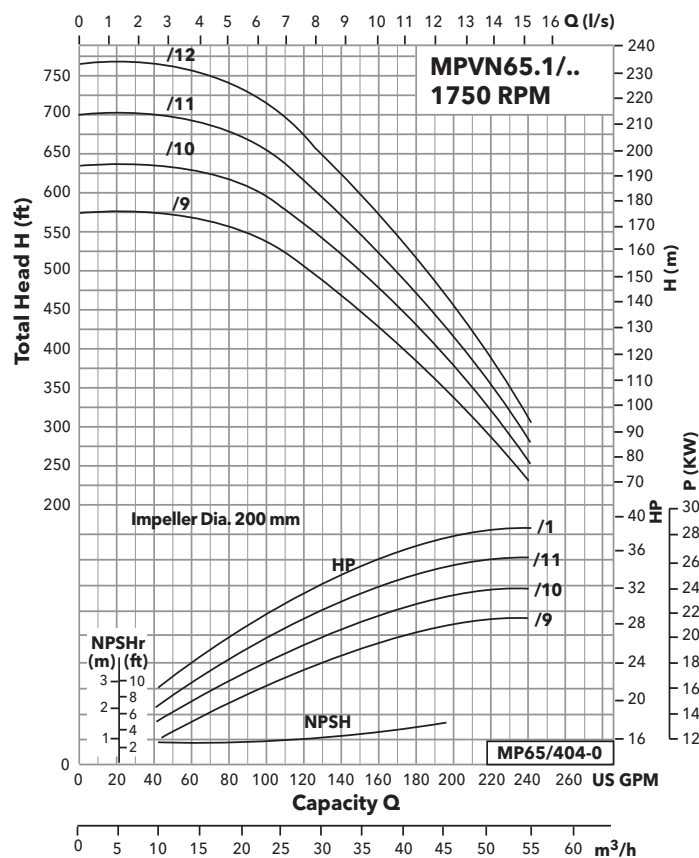
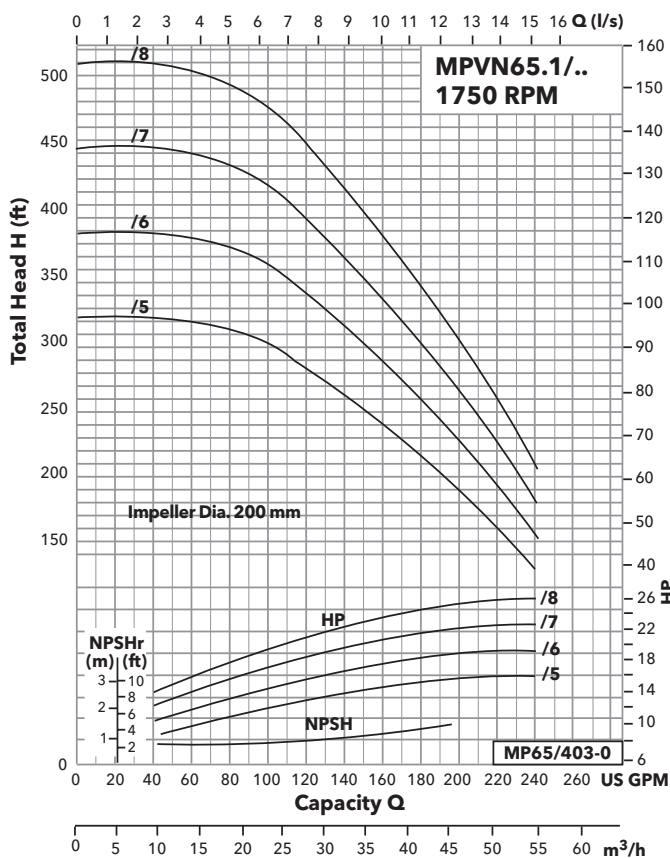
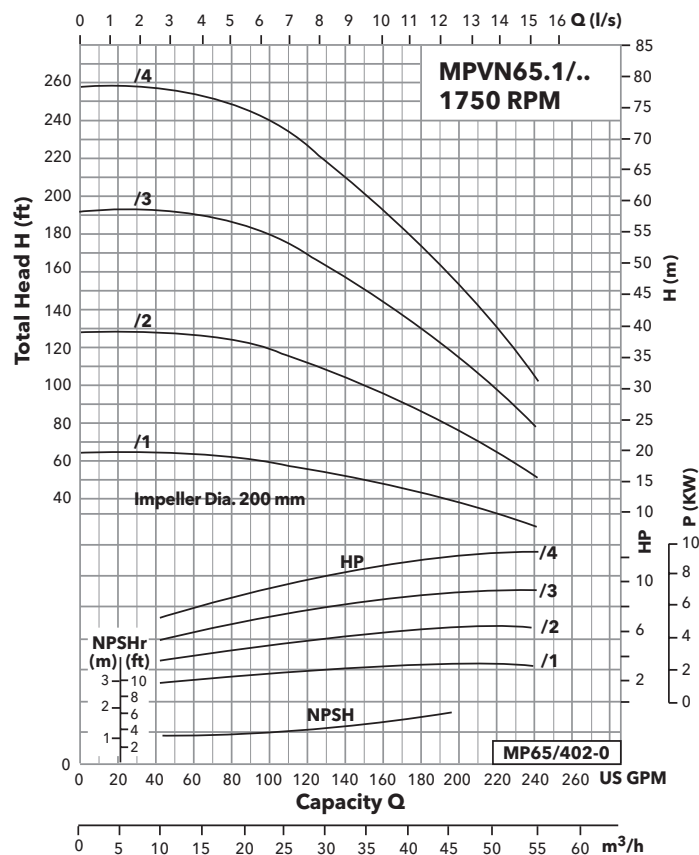
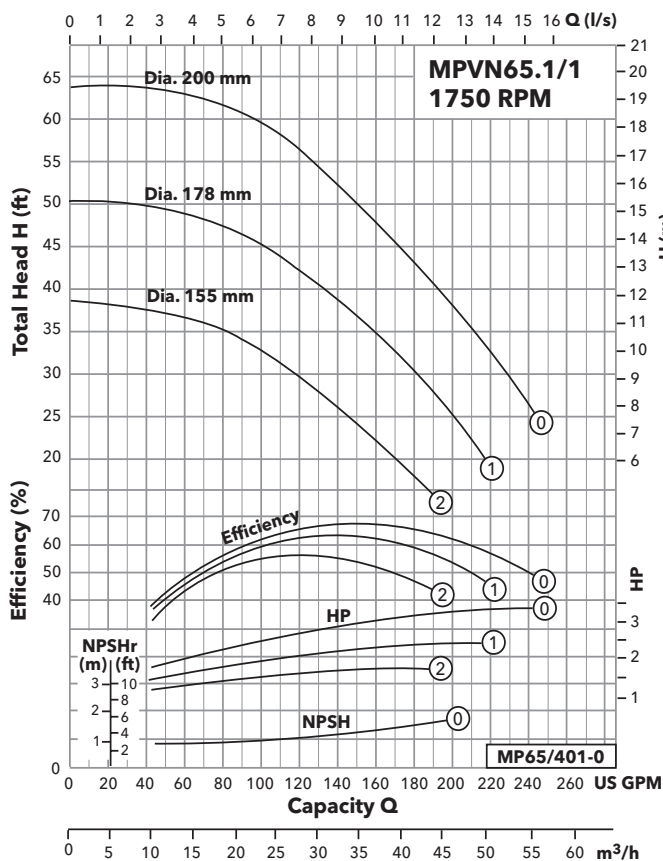

SELECTION CHARTS MPVN 65.2 n = 1750 RPM

Single Stage

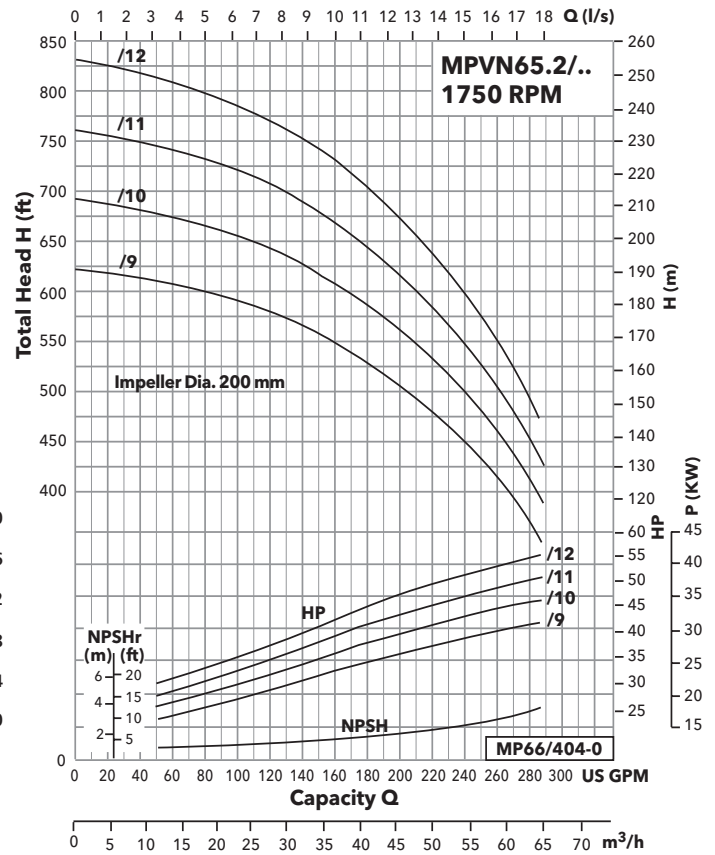
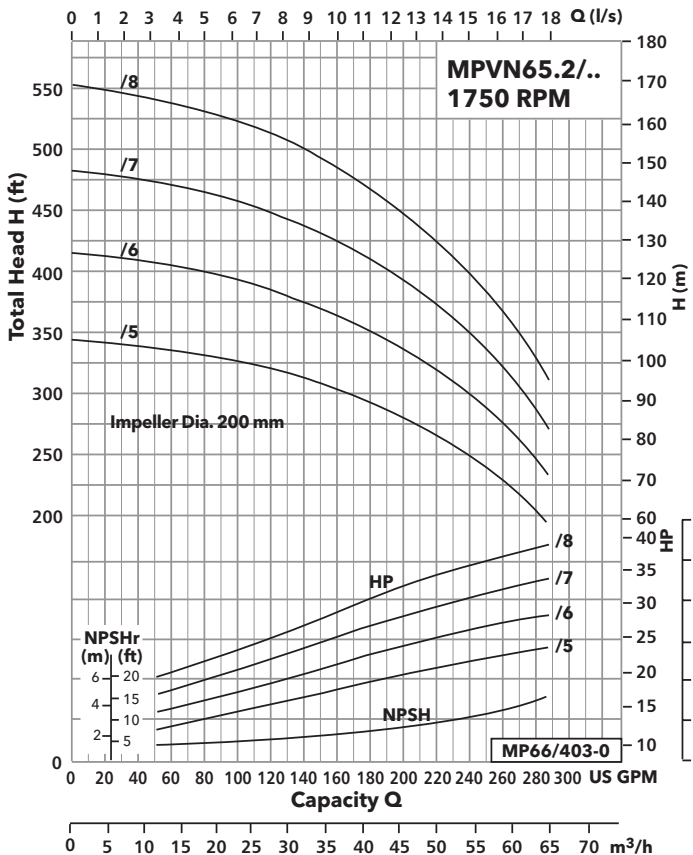
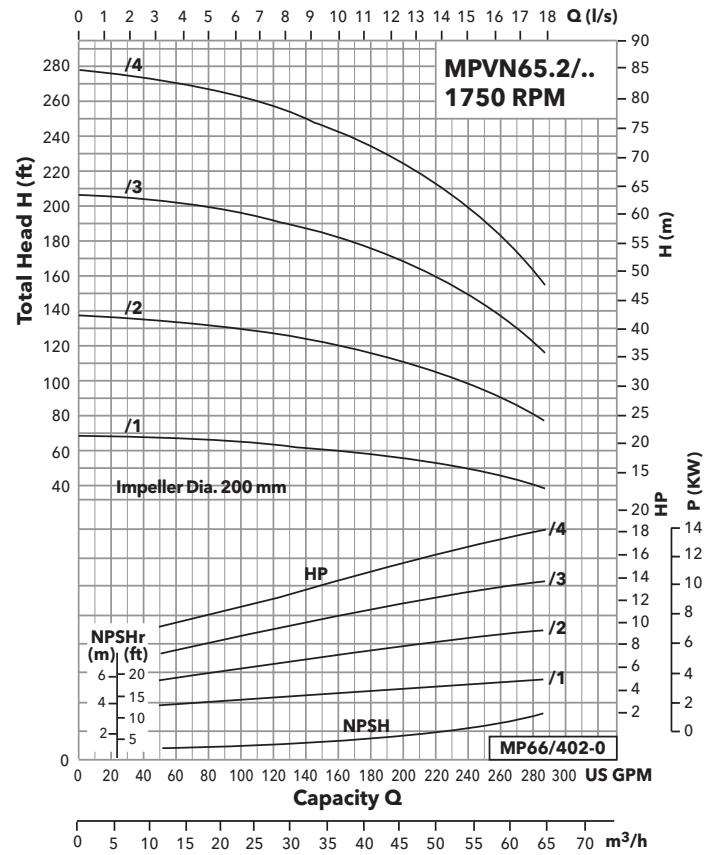
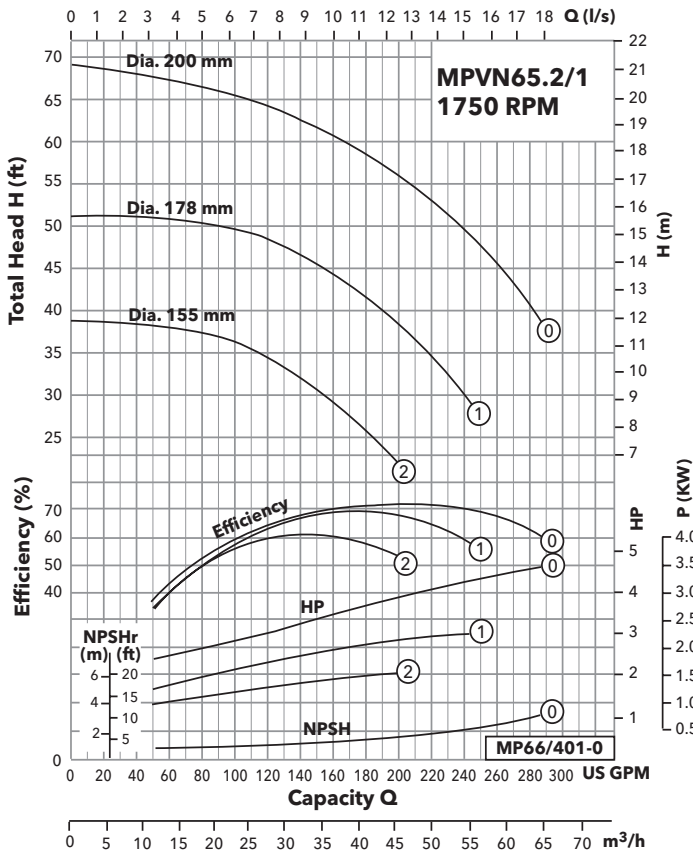

MPVN STANDARD CONSTRUCTION MPVN65.1, MPVN65.2

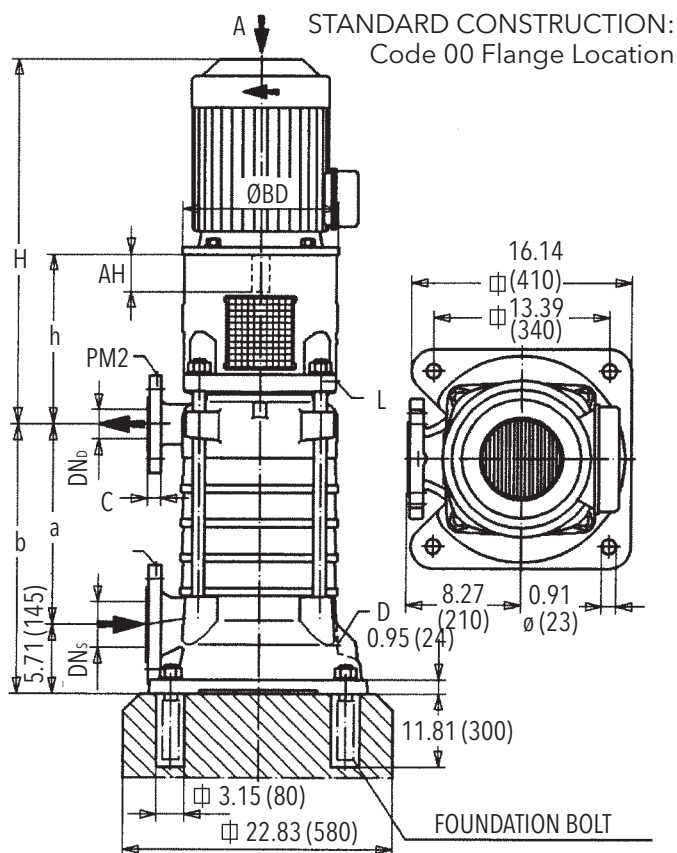

Number of Stages

	1*)	2*)	3	4	5	6	7	8	9
a	4.92 (125)	7.68 (195)	10.43 (265)	13.19 (335)	15.94 (405)	18.70 (475)	21.46 (545)	24.21 (615)	26.97 (685)
b	10.63 (270)	13.39 (340)	16.14 (410)	18.90 (480)	21.65 (550)	24.41 (620)	27.17 (690)	29.92 (760)	32.68 (830)

	10	11	12
a	29.72 (755)	32.48 (825)	35.24 (895)
b	35.43 (900)	38.19 (970)	40.94 (1040)

NEMA Motor	HP (rpm)		h	H	BD	AH
	3550	1750				
254TD	15	15	16.89 (429)	36.06 (916)	14.02 (356)	4.00 (101.6)
256TD	20	20	16.89 (429)	36.06 (916)	14.02 (356)	4.00 (101.6)
284TD	-	25	16.89 (429)	38.82 (986)	14.02 (356)	4.62 (117.3)
284TSD	25	-	16.89 (429)	38.82 (986)	14.02 (356)	3.25 (82.5)
286TD	-	30	16.89 (429)	38.82 (986)	14.02 (356)	4.62 (117.3)
286TSD	30	-	16.89 (429)	38.82 (986)	14.02 (356)	3.25 (82.5)
324TD	-	40	18.07 (459)	40.98 (1041)	17.99 (457)	5.25 (133.4)
324TSD	40	-	16.89 (429)	39.80 (1011)	17.99 (457)	3.75 (95.3)
326TD	-	50	18.07 (459)	40.98 (1041)	17.99 (457)	5.25 (133.4)
326TSD	50	-	16.89 (429)	39.80 (1011)	17.99 (457)	3.75 (95.3)
364TSD	60	-	16.89 (429)	40.71 (1034)	17.99 (457)	3.75 (95.3)
365TD	-	75	18.07 (459)	41.89 (1064)	17.99 (457)	5.88 (149.4)
365TSD	75	-	16.89 (429)	40.71 (1034)	17.99 (457)	3.75 (95.3)
405TSD	100	-	18.07 (459)	44.80 (1138)	22.01 (559)	4.25 (108.0)
444TSD	125	-	18.07 (459)	49.21 (1250)	22.01 (559)	4.75 (120.7)
445TSD	150	-	18.07 (459)	49.21 (1250)	22.01 (559)	4.75 (120.7)
447TSD	200	-	18.07 (459)	49.21 (1250)	22.01 (559)	4.75 (120.7)

ALTERNATIVE FLANGE LOCATIONS

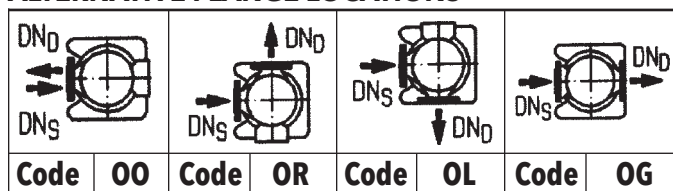

PUMP FLANGES

ASME B16.5							
DN	Class	D	K	C	d	L	z
Discharge 2½ (in.)	150	7.52 (191)	5.51 (140)	0.94 (24)	4.13 (105)	¾ (19)	4
	300	7.52 (191)	5.87 (149)	0.94 (24)	4.13 (105)	⅞ (22)	8
	600	8.07 (205)	5.87 (149)	1.10 (28)	4.13 (105)	⅞ (22)	8
Suction 4 (in.)	150	9.25 (235)	7.52 (191)	1.06 (27)	6.18 (157)	¾ (19)	8
	300	10.00 (254)	7.87 (200)	1.06 (27)	6.18 (157)	⅞ (22)	8

Dimensions in inches (mm).

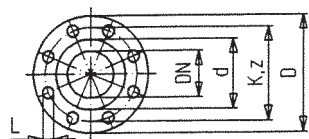

PM1 = Suction Gauge Conn. G1/4
 PM2 = Discharge Gauge Conn. G1/4
 L = Vent Conn. G1/2
 D = Drain Conn. G1/4

*) = Code 00 not possible, normal configuration code OG
 Dimensions in inches (mm).

SELECTION CHARTS MPVN 100.1 n = 3550 RPM

Single Stage

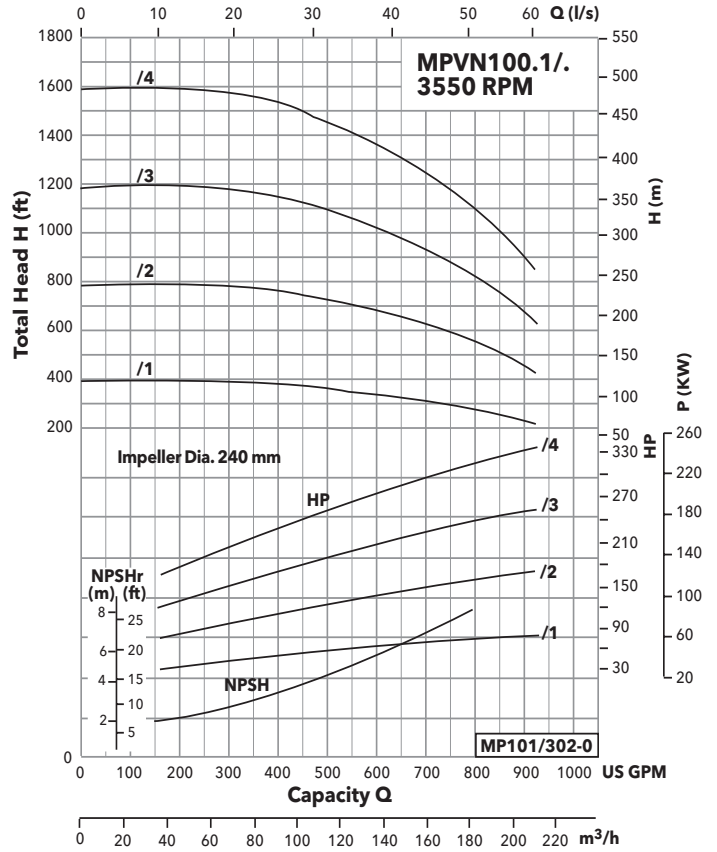
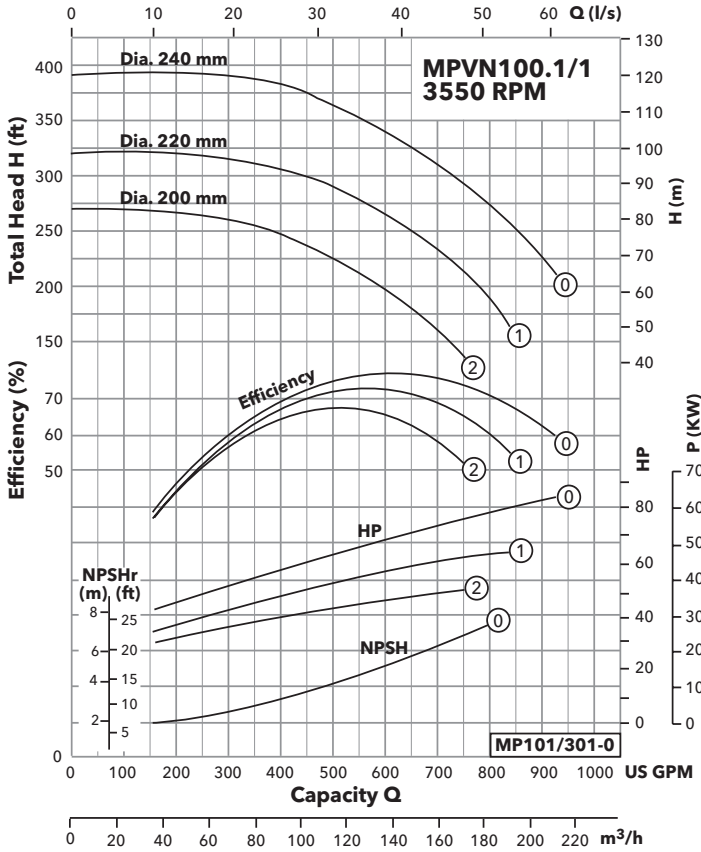

SELECTION CHARTS MPVN 100.2 n = 3550 RPM

Single Stage

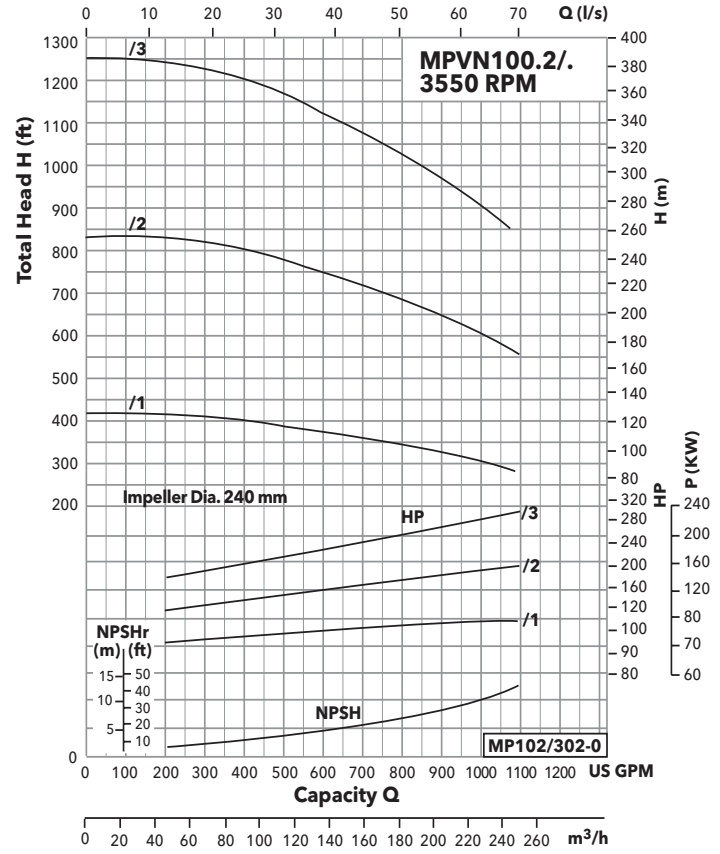
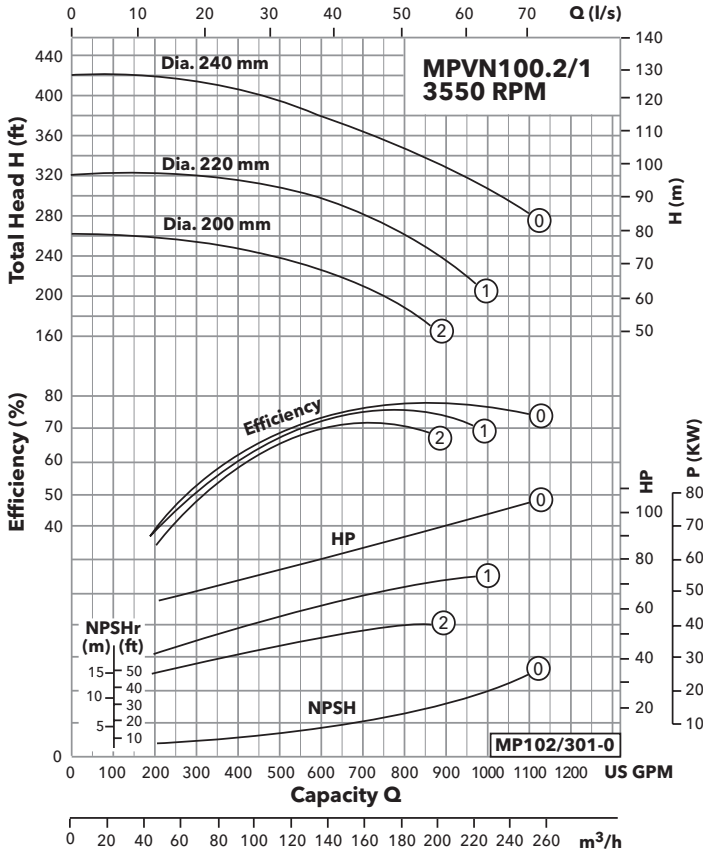

SELECTION CHARTS MPVN 100.1 n = 1750 RPM

Single Stage

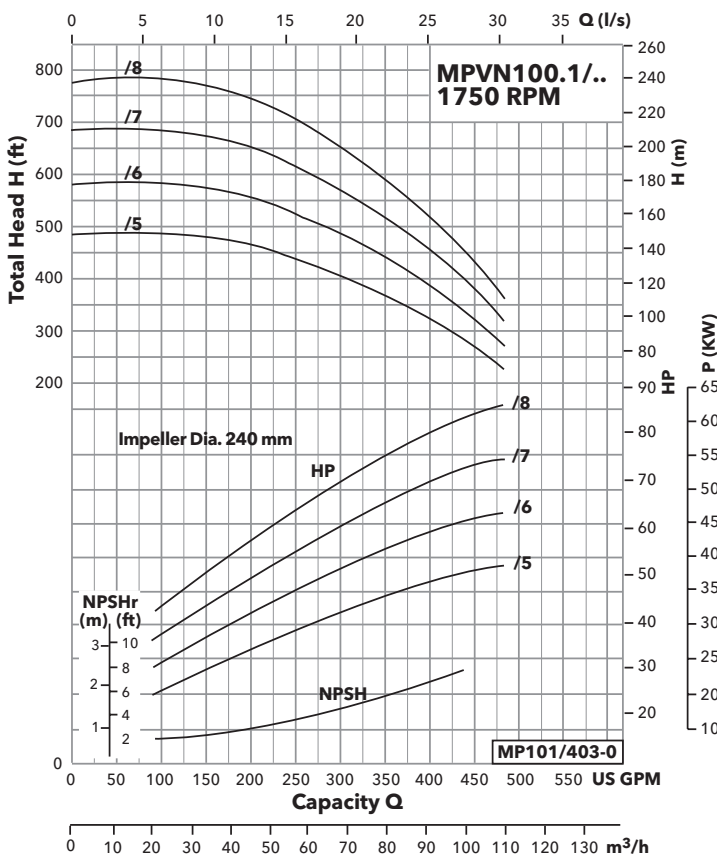
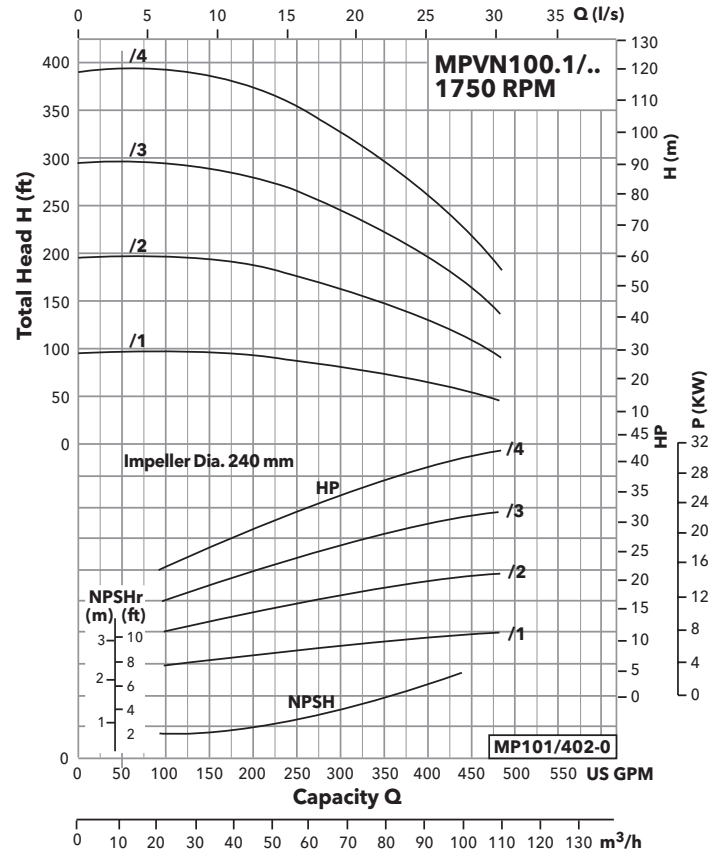
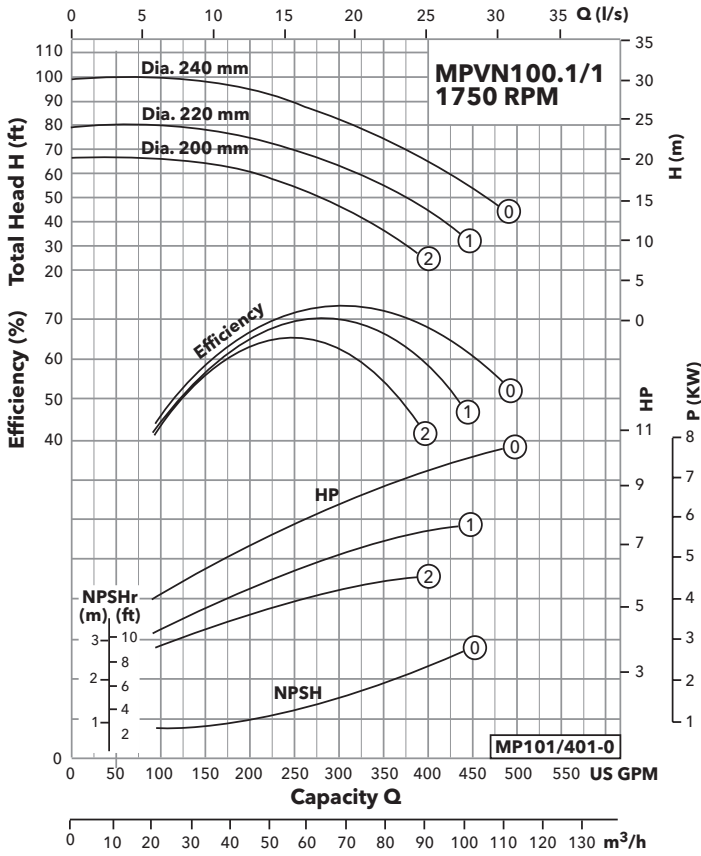

SELECTION CHARTS MPVN 100.2 n = 1750 RPM

Single Stage

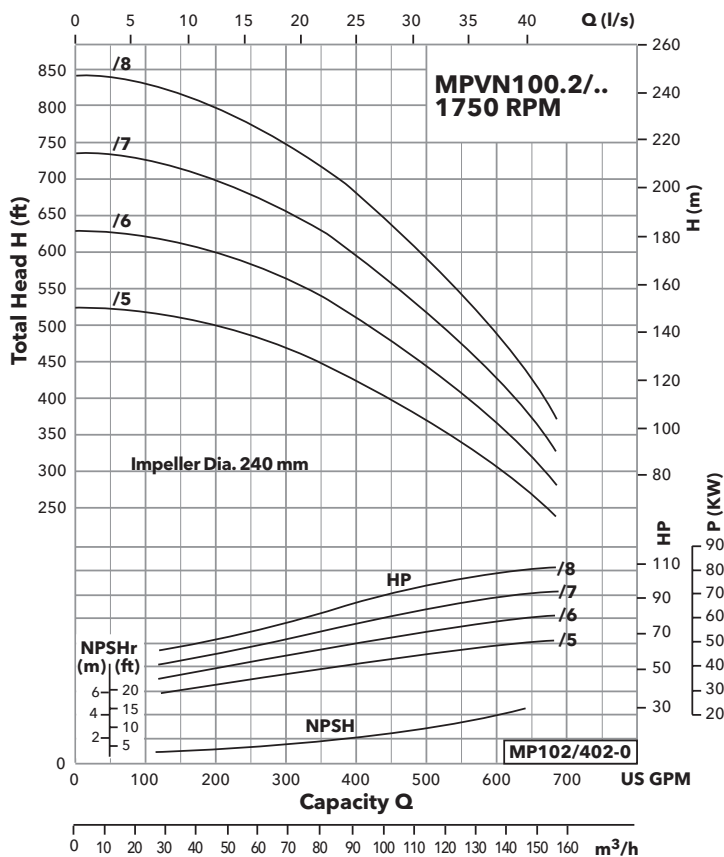
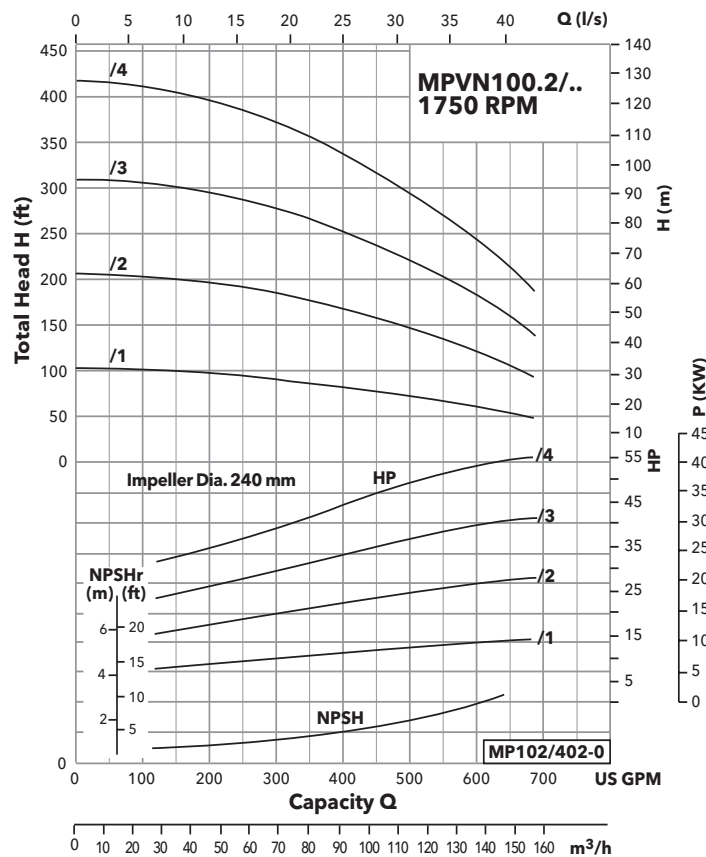
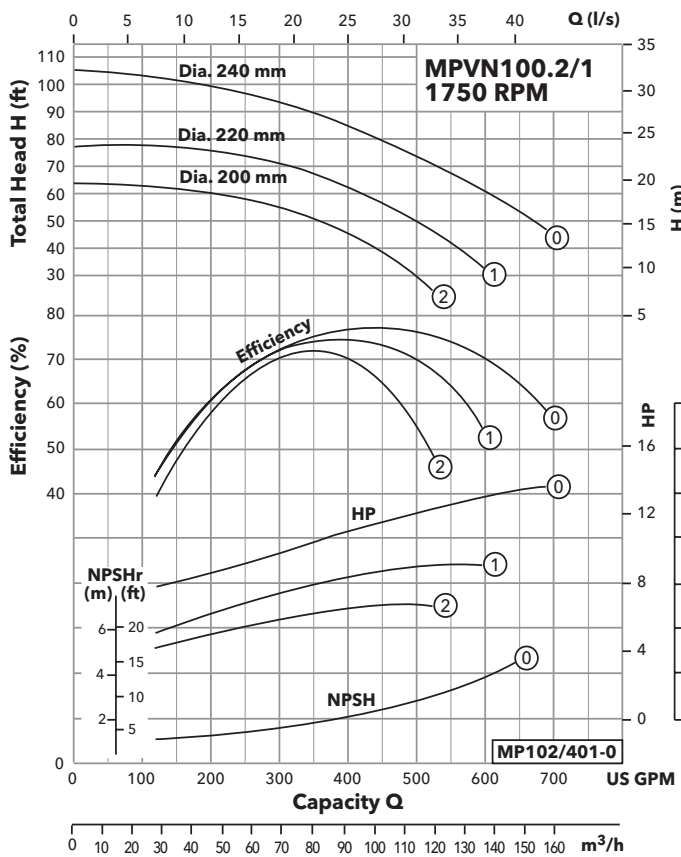

MPVN STANDARD CONSTRUCTION MPVN100.1, MPVN100.2

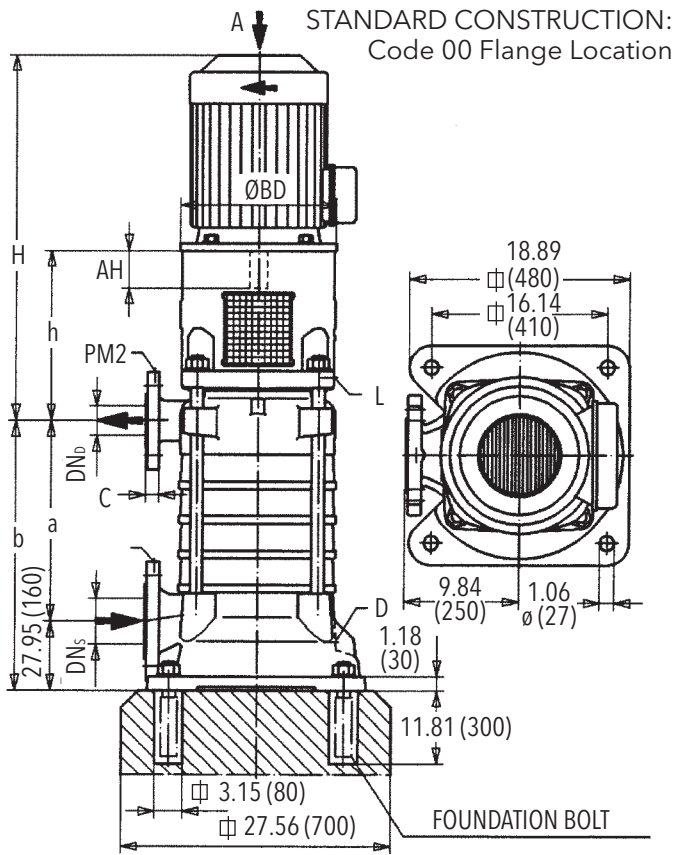

Number of Stages

	1*)	2*)	3	4	5
a	6.89 (175)	10.24 (260)	13.58 (345)	16.93 (430)	20.28 (515)
b	13.19 (335)	16.54 (420)	19.88 (505)	23.23 (590)	26.57 (675)
	6	7	8		
a	23.62 (600)	26.97 (685)	30.31 (770)		
b	29.92 (760)	33.27 (845)	36.61 (915)		

NEMA Motor	HP (rpm)		h	H	BD	AH
	3550	1750				
254TD	-	15	19.06 (484)	38.23 (971)	14.02 (356)	4.00 (101.6)
256TD	-	20	19.06 (484)	38.23 (971)	14.02 (356)	4.00 (101.6)
284TD	-	25	19.06 (484)	40.98 (1041)	14.02 (356)	4.00 (101.6)
286TD	-	30	19.06 (484)	40.98 (1041)	14.02 (356)	4.00 (101.6)
324TSD	-	40	20.24 (514)	43.15 (1096)	17.99 (457)	5.25 (133.4)
326TD	-	50	20.24 (514)	43.15 (1096)	17.99 (457)	5.25 (133.4)
364TD	-	60	20.24 (514)	44.06 (1119)	17.99 (457)	5.88 (149.4)
364TSD	60	-	19.06 (484)	42.87 (1089)	17.99 (457)	3.75 (95.3)
365TD	-	75	19.06 (484)	44.06 (1119)	17.99 (457)	5.88 (149.4)
365TSD	75	-	20.24 (514)	42.87 (1089)	17.99 (457)	3.75 (95.3)
405TD	-	100	19.06 (484)	48.35 (1228)	22.01 (559)	7.25 (184.2)
405TSD	100	-	21.61 (514)	46.97 (1193)	22.01 (559)	4.25 (108.0)
444TSD	125	-	20.24 (514)	51.38 (1305)	22.01 (559)	4.75 (120.7)
445TSD	150	-	20.24 (514)	51.38 (1305)	22.01 (559)	4.75 (120.7)
447TSD	200	-	20.24 (514)	55.39 (1407)	22.01 (559)	4.75 (120.7)
449TSD	250	-	20.24 (514)	58.39 (1483)	22.01 (559)	4.75 (120.7)
449TSD	300	-	20.24 (514)	58.39 (1483)	22.01 (559)	4.75 (120.7)
449TSD	350	-	20.24 (514)	58.39 (1483)	22.01 (559)	4.75 (120.7)

ALTERNATIVE FLANGE LOCATIONS

Code OO	Code OR	Code OL	Code OG

PUMP FLANGES

ASME B16.5							
DN	Class	D	K	C	d	L	z
Discharge 4 (in.)	150	9.25 (235)	7.52 (191)	1.06 (27)	6.14 (156)	3/4 (19)	8
	300	10.75 (273)	7.87 (200)	1.26 (32)	6.14 (156)	7/8 (22)	8
	600	10.75 (273)	8.50 (216)	1.26 (32)	6.14 (156)	1 (25)	8
Suction 5 (in.)	150	10.98 (279)	8.50 (216)	1.14 (29)	7.24 (184)	7/8 (22)	8
	300	10.98 (279)	9.25 (235)	1.14 (29)	7.24 (184)	7/8 (22)	8

Dimensions in inches (mm)

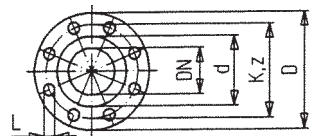

PM1 = Suction Gauge Conn. G1/4
 PM2 = Discharge Gauge Conn. G1/4
 L = Vent Conn. G1/2
 D = Drain Conn. G1/4

*) = Code OO not possible, normal configuration code OG
 Dimensions in inches (mm).

SELECTION CHARTS MPVN 125.1 n = 3550 RPM

Single Stage

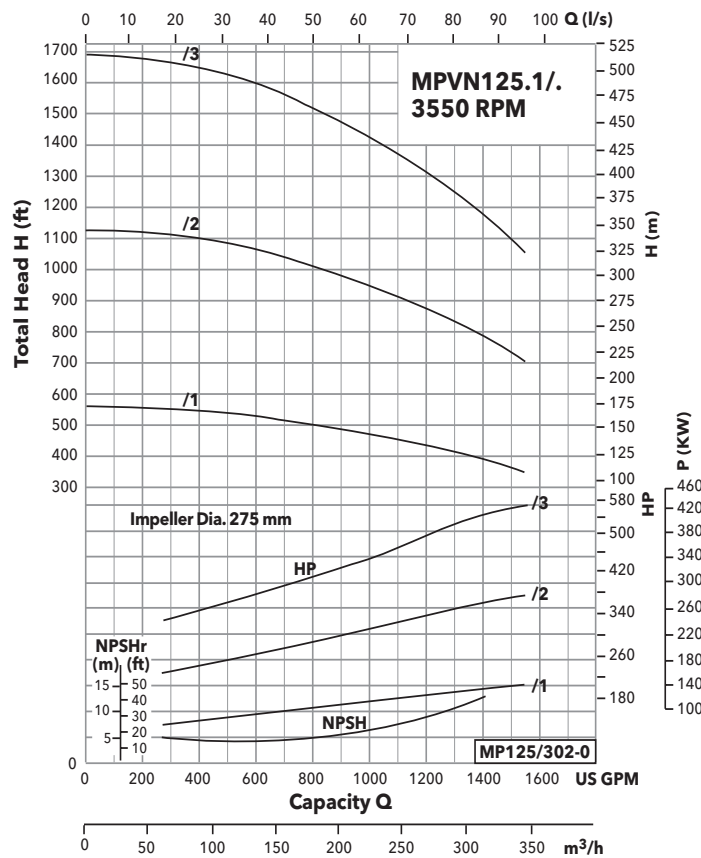
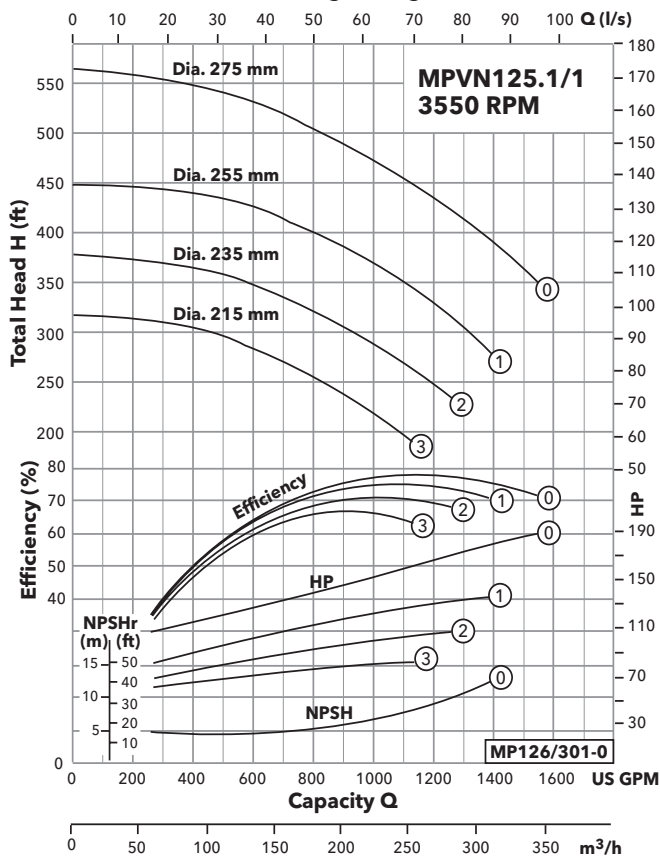

SELECTION CHARTS MPVN 125.2 n = 3550 RPM

Single Stage

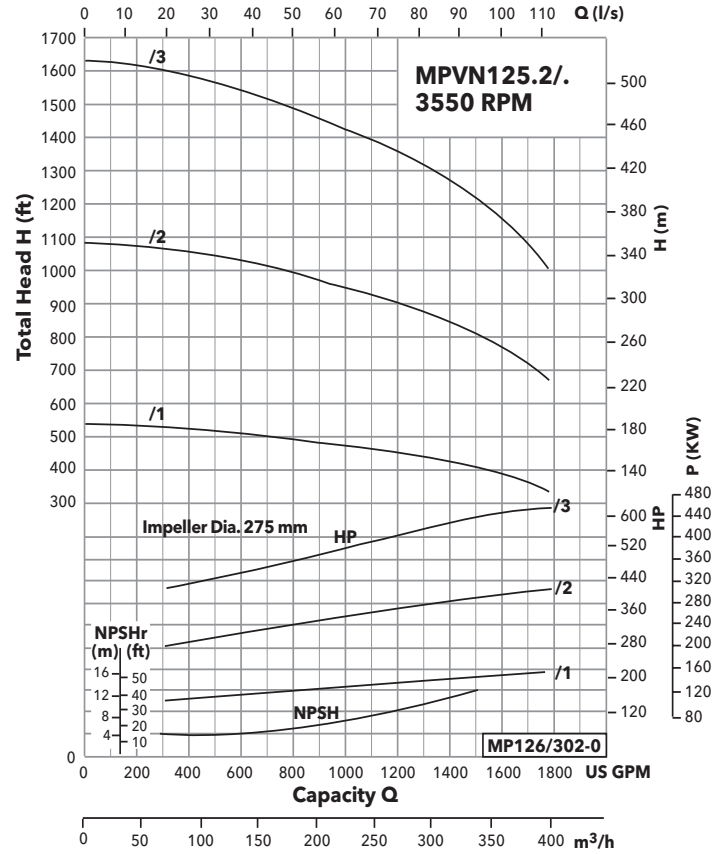
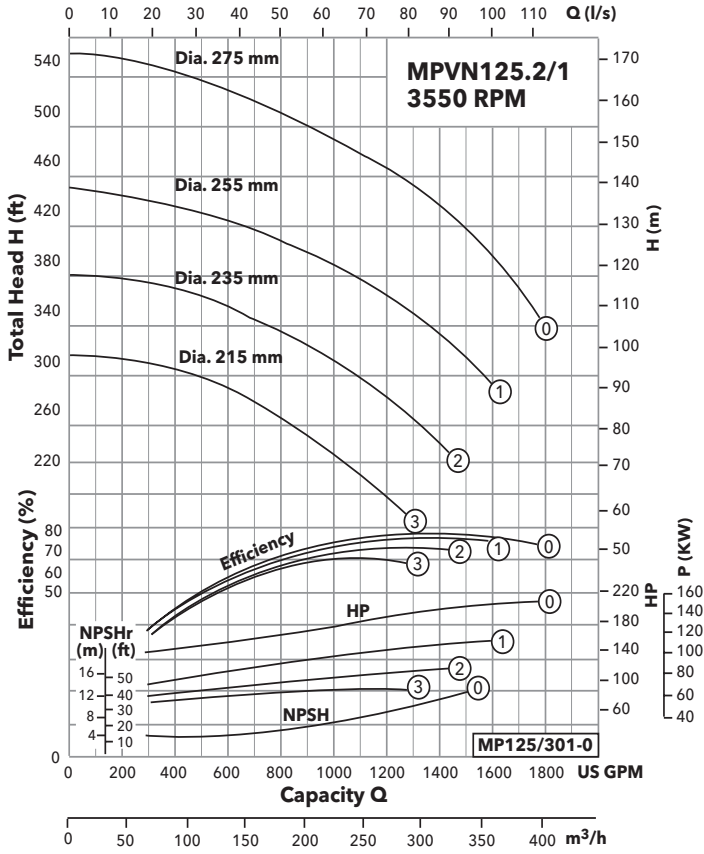

SELECTION CHARTS MPVN 125.1 n = 1750 RPM

Single Stage

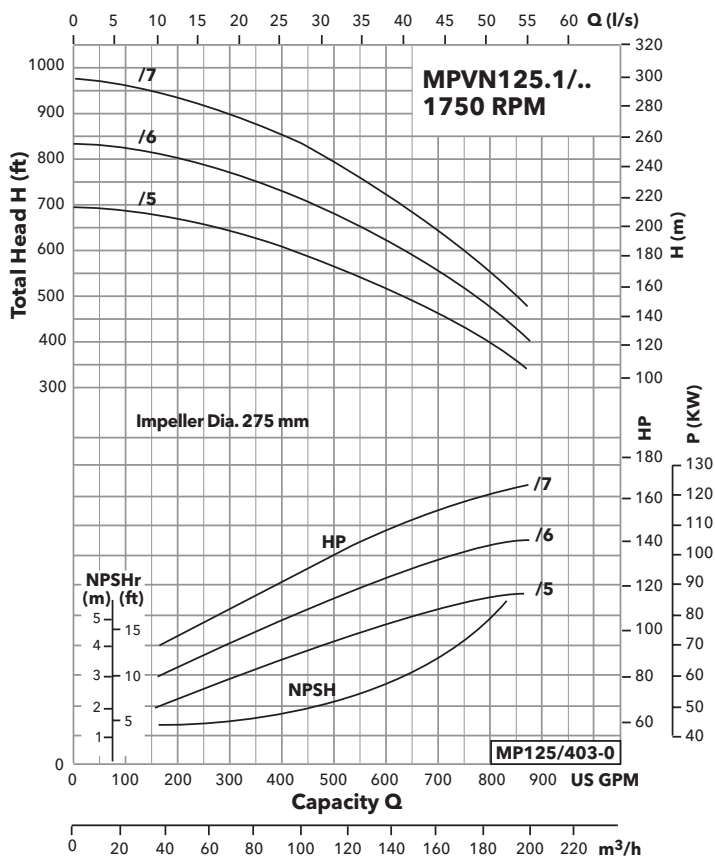
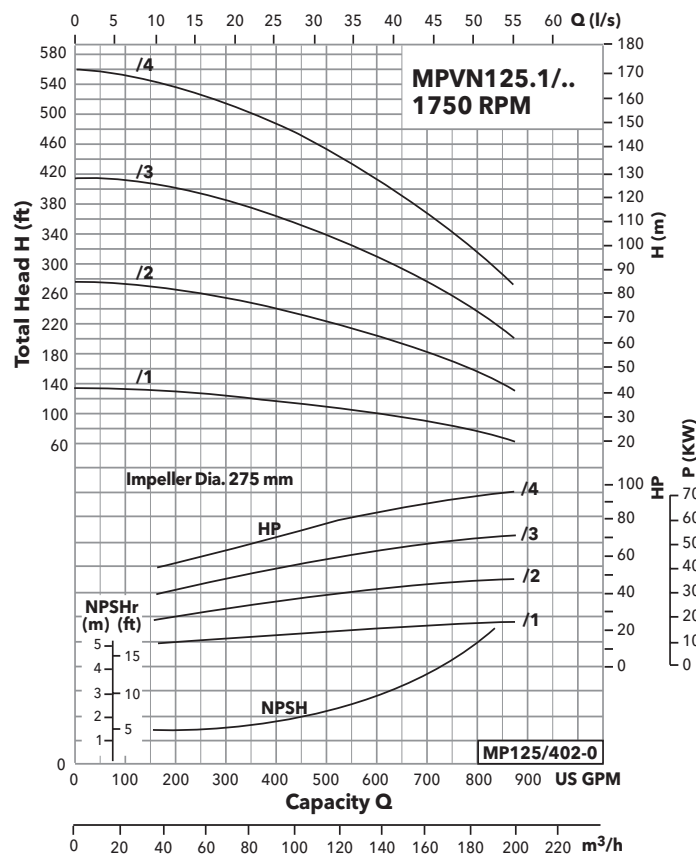
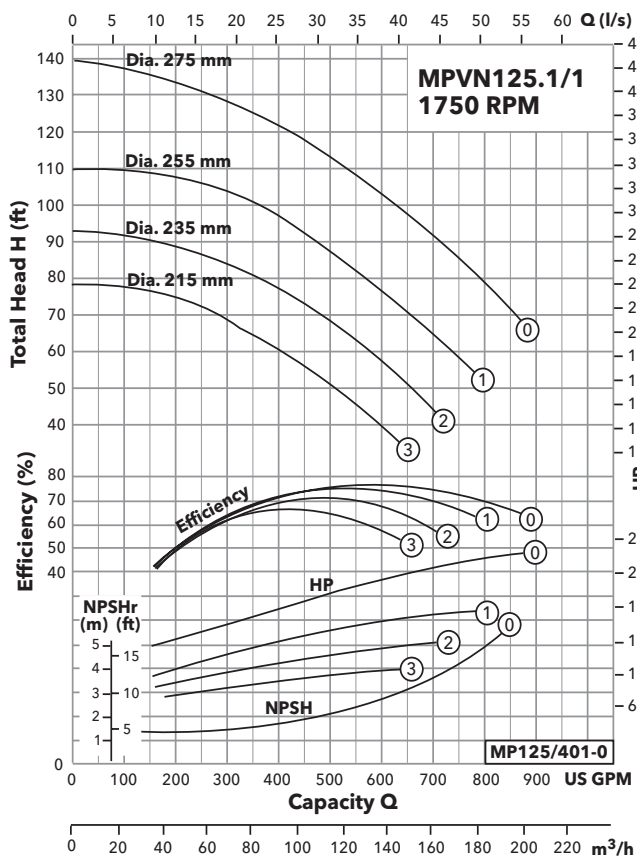

SELECTION CHARTS MPVN 125.2 n = 1750 RPM

Single Stage

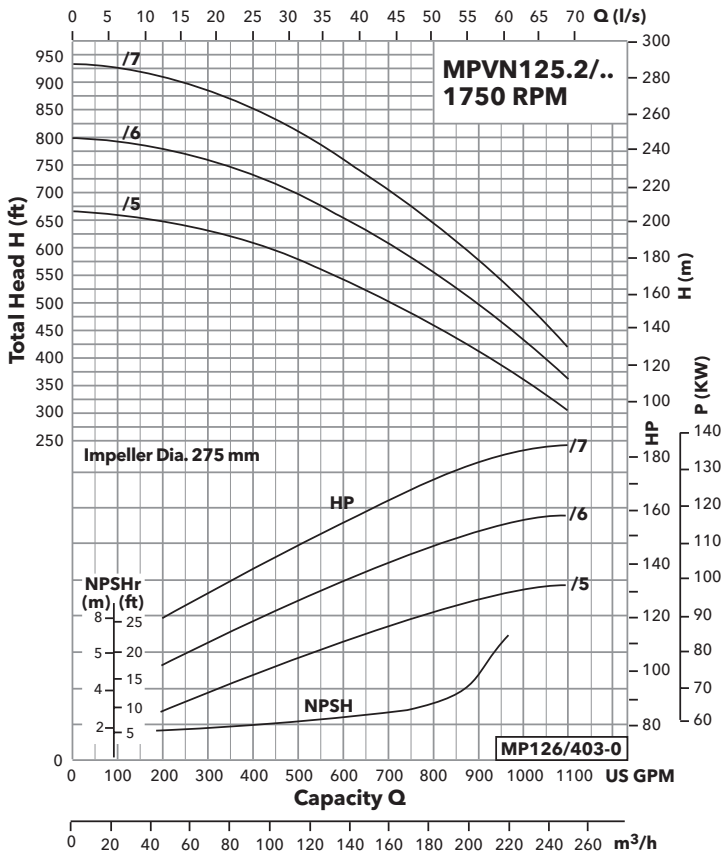
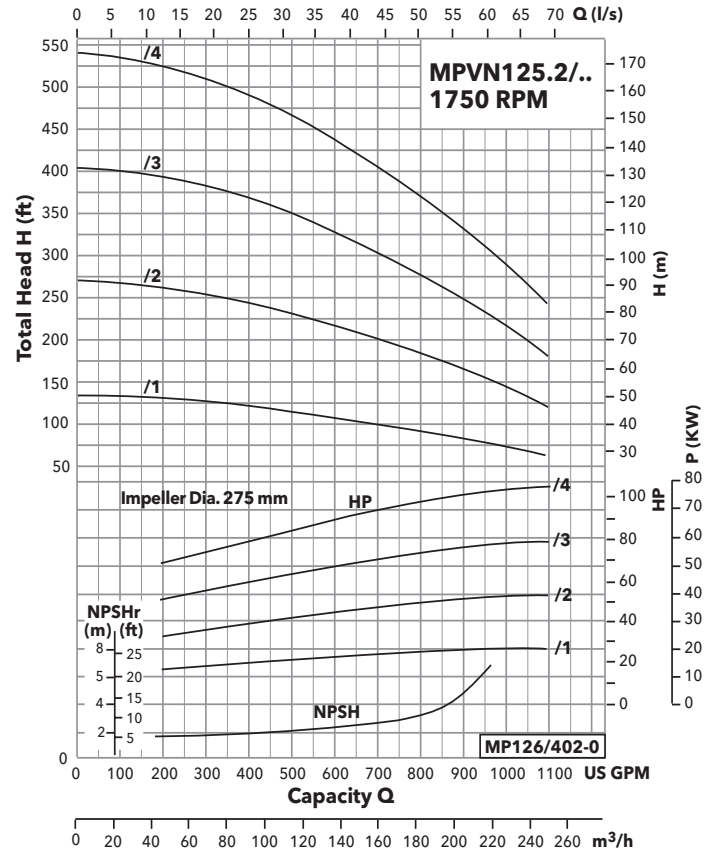
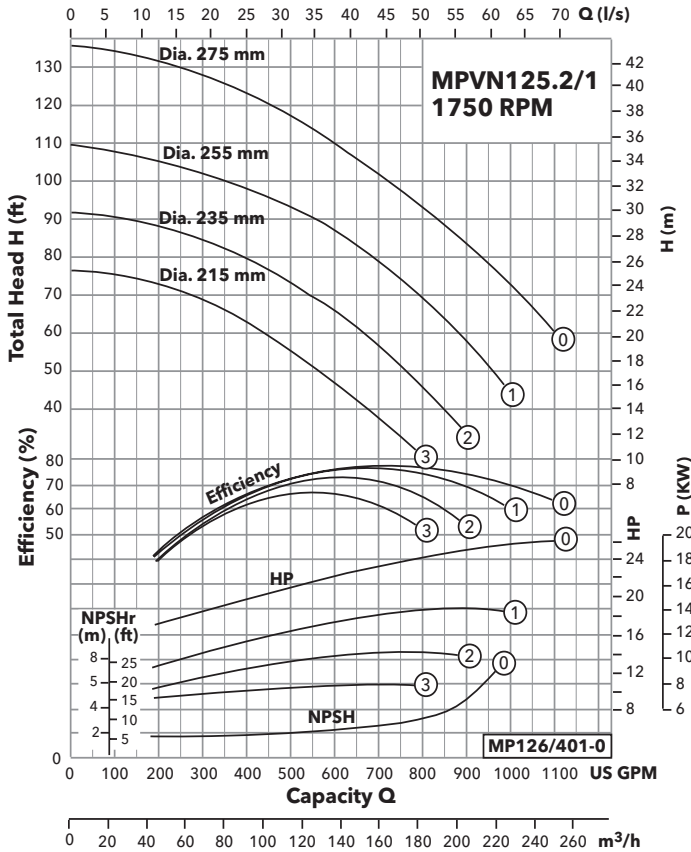

MPVN STANDARD CONSTRUCTION MPVN125.1, MPVN125.2

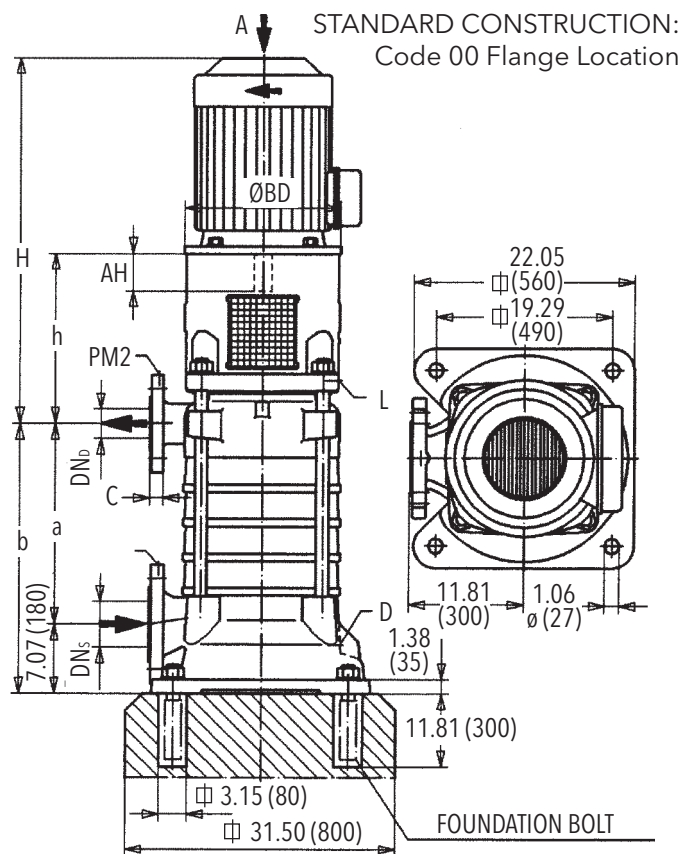

Number of Stages

	1*)	2*)	3	4	5	6	7
a	8.66 (220)	12.80 (325)	16.93 (430)	21.06 (535)	25.20 (640)	29.33 (745)	33.46 (850)
b	15.75 (400)	19.88 (505)	24.02 (610)	28.15 (715)	32.28 (820)	36.42 (925)	40.55 (1030)

NEMA Motor	HP (rpm)		h	H	BD	AH
	3550	1750				
324TD	-	40	23.50 (597)	47.13 (1197)	17.99 (457)	5.25 (133.4)
326TD	-	50	23.50 (597)	47.13 (1197)	17.99 (457)	5.25 (133.4)
364TD	-	60	23.50 (597)	47.32 (1202)	17.99 (457)	5.88 (149.4)
365TD	-	75	23.50 (597)	47.32 (1202)	17.99 (457)	5.88 (149.4)
405TD	-	100	25.98 (660)	52.72 (1339)	22.01 (559)	7.25 (184.2)
405TSD	100	-	23.50 (597)	50.35 (1279)	22.01 (559)	4.25 (108.0)
444TD	-	125	25.98 (660)	57.13 (1451)	22.01 (559)	8.50 (215.9)
444TSD	125	-	23.50 (597)	54.65 (1388)	22.01 (559)	4.75 (120.7)
445TD	-	150	23.50 (660)	57.13 (1451)	22.01 (559)	8.50 (215.9)
445TSD	150	-	25.98 (597)	54.65 (1388)	22.01 (559)	4.75 (120.7)
447TD	-	200	23.50 (660)	61.14 (1553)	22.01 (559)	8.50 (215.9)
447TSD	200	-	25.98 (597)	58.66 (1490)	22.01 (559)	4.75 (120.7)
449TD	-	250	25.98 (660)	64.13 (1629)	22.01 (559)	8.50 (215.9)
449TSD	250	-	23.50 (597)	61.65 (1566)	22.01 (559)	4.75 (120.7)
449TSD	300	-	23.50 (597)	61.65 (1566)	22.01 (559)	4.75 (120.7)
449TSD	350	-	23.50 (597)	61.65 (1566)	22.01 (559)	4.75 (120.7)
449TSD	400	-	23.50 (597)	61.65 (1566)	22.01 (559)	4.75 (120.7)
500TSD	500	-	23.50 (630)	69.80 (1773)	25.00 (635)	4.75 (120.7)

ALTERNATIVE FLANGE LOCATIONS

Code OO	Code OR	Code OL	Code OG

PUMP FLANGES

ASME B16.5							
DN	Class	D	K	C	d	L	z
Discharge 5 (in.)	150	10.98 (279)	8.50 (216)	1.14 (29)	7.24 (184)	7/8 (22)	8
	300	10.98 (279)	9.25 (235)	1.14 (29)	7.24 (184)	7/8 (22)	8
	600	12.99 (330)	10.51 (267)	1.38 (35)	7.24 (184)	1 1/8 (29)	8
Suction 6 (in.)	150	11.81 (300)	9.49 (241)	1.26 (32)	8.31 (211)	7/8 (22)	8
	300	12.48 (317)	10.63 (270)	1.26 (32)	8.31 (211)	7/8 (22)	12

Dimensions in inches (mm)

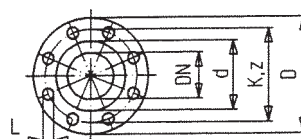

PM1 = Suction Gauge Conn. G1/4

PM2 = Discharge Gauge Conn. G1/4

L = Vent Conn. G1/2

D = Drain Conn. G1/4

*) = Code OO not possible, normal configuration code OG
Dimensions in inches (mm).

Xylem |'zīləm|

- 1) The tissue in plants that brings water upward from the roots;
- 2) a leading global water technology company.

We're 12,500 people unified in a common purpose: creating innovative solutions to meet our world's water needs. Developing new technologies that will improve the way water is used, conserved, and re-used in the future is central to our work. We move, treat, analyze, and return water to the environment, and we help people use water efficiently, in their homes, buildings, factories and farms. In more than 150 countries, we have strong, long-standing relationships with customers who know us for our powerful combination of leading product brands and applications expertise, backed by a legacy of innovation.

For more information on how Xylem can help you, go to www.xyleminc.com



Xylem, Inc.
2881 East Bayard Street Ext., Suite A
Seneca Falls, NY 13148
Phone: (800) 453-6777
Fax: (888) 322-5877
www.xyleminc.com/brands/gouldswatertechnology

Goulds is a registered trademark of Goulds Pumps, Inc. and is used under license.
© 2012 Xylem Inc. BMPVN April 2010