

Models LP301A & LP600



Contents:

Installation Instructions:	page 2
LP301A Specifications:	page 3
Exploded View:	page 4
Parts List / Kits:	page 5
LP600 Specifications:	page 6
Repair Instructions:	page 7-10
Pump Mounting Selection Guide:	page 10
Torque Specifications:	page 10
Trouble Shooting/Preventative Maintenance Check-List & Recommended Spare Parts List:	page 11
Dimensions:	back page
Warranty Information:	back page

INSTALLATION INSTRUCTIONS

Installation of the Giant Industries, Inc., pump is not a complicated procedure, but there are some basic steps common to all pumps. The following information is to be considered as a general outline for installation. If you have unique requirements, please contact Giant Industries, Inc. or your local distributor for assistance.

1. The pump should be installed flat on a base to a maximum of a 15 degree angle of inclination to ensure optimum lubrication.
2. The inlet to the pump should be sized for the flow rate of the pump with no unnecessary restrictions that can cause cavitation. Teflon tape should be used to seal all joints. If pumps are to be operated at temperatures in excess of 140° F, it is important to insure a positive head to the pump to prevent cavitation.
3. The discharge plumbing from the pump should be properly sized to the flow rate to prevent line pressure loss to the work area. It is essential to provide a safety bypass valve between the pump and the work area to protect the pump from pressure spikes in the event of a blockage or the use of a shut-off gun.

4. Use of a dampener is necessary to minimize pulsation at drive elements, plumbing, connections, and other system areas. The use of a dampener with Giant Industries, Inc. pumps is optional, although recommended by Giant Industries, Inc. to further reduce system pulsation. Dampeners can also reduce the severity of pressure spikes that occur in systems using a shut-off gun. A dampener must be positioned downstream from the unloader.

5. Crankshaft rotation on Giant Industries, Inc. pumps should be made in the direction designated by the arrows on the pump crankcase. Reverse rotation may be safely achieved by following a few guidelines available upon request from Giant Industries, Inc. Required horsepower for system operation can be obtained from the charts on pages 3 and 6.

6. Before beginning operation of your pumping system, remember: Check that the crankcase and seal areas have been properly lubricated per recommended schedules. Do not run the pump dry for extended periods of time. Cavitation will result in severe damage. Always remember to check that all plumbing valves are open and that pumped media can flow freely to the inlet of the pump.

Finally, remember that high pressure operation in a pump system has many advantages. But, if it is used carelessly and without regard to its potential hazard, it can cause serious injury.

IMPORTANT OPERATING CONDITIONS

Failure to comply with any of these conditions invalidates the warranty.

1. Prior to initial operation, add oil to the crankcase so that oil level is between the two lines on the oil dipstick. **DO NOT OVERFILL.**

Use SAE 85-140 industrial gear oil

Crankcase oil should be changed after the first 50 hours of operation, then at regular intervals of 500 hours or less depending on operating conditions.

2. Pump operation must not exceed rated pressure, volume, or RPM. A pressure relief device must be installed in the discharge of the system.

3. Acids, alkalines, or abrasive fluids cannot be pumped unless approval in writing is obtained before operation from Giant Industries, Inc.

4. Run the pump dry approximately 10 seconds to drain the water before exposure to freezing temperatures.

NOTE: Contact Giant Industries for Service School Information. Phone: (419)-531-4600

Specifications Model LP301A

Ratings (continuous)	14.1 GPM @ 4000 PSI @ 1000 RPM
Ratings (intermittent)	18 GPM @ 4000 PSI @ 1277 RPM
Inlet Pressure	Up to 140
Plunger Diameter	24 mm
Stroke	42 mm
Crankcase Oil Capacity	100 fl.oz.
Temperature of Pumped Fluids	Up to 140 °F
Inlet Port	1-1/4" BSP
Discharge Port	1" BSP
Crankshaft Mounting	Either Side
Shaft Rotation	Top of Pulley Towards Fluid End
Weight	110 lbs.
Crankshaft Diameter	35 mm

PULLEY INFORMATION

Pulley selection and pump speed are based on a 1725 RPM motor and "B" section belts. When selecting desired GPM, allow for a ±5% tolerance on pumps output due to variations in pulleys, belts and motors among manufacturers.

1. Select GPM required, then select appropriate motor and pump pulley from the same line.
2. The desired pressure is achieved by selecting the correct nozzle size that corresponds with the pump GPM.

HORSEPOWER INFORMATION

We recommend that a 1.1 service factor be specified when selecting an electric motor as the power source. To compute specific pump horsepower requirements, use the following formula:

$$HP = (GPM \times PSI) / 1440$$

LP301A PULLEY SELECTION AND HORSEPOWER REQUIREMENTS							
PUMP PULLEY	MOTOR PULLEY	RPM	GPM	2500 PSI	3000 PSI	3500 PSI	4000 PSI
12.75"	3.95"	500	7.05	12.2	14.7	17.1	19.6
12.75"	4.95"	640	9.02	15.6	18.8	21.9	25.1
12.75"	5.75"	750	10.57	18.4	22.0	25.7	29.4
12.75"	6.15"	805	11.35	19.7	23.6	27.6	31.5
12.75"	6.55"	865	12.2	21.2	25.4	29.6	33.9
12.75"	6.95"	940	13.25	23.0	27.6	32.2	36.8
12.75"	7.50"	1000	14.1	24.5	29.4	34.3	39.2
12.75"	7.50"	1277	18.0*	31.3	37.5	43.8	50.0*

* Intermittent duty only

Exploded View - LP301A/LP600

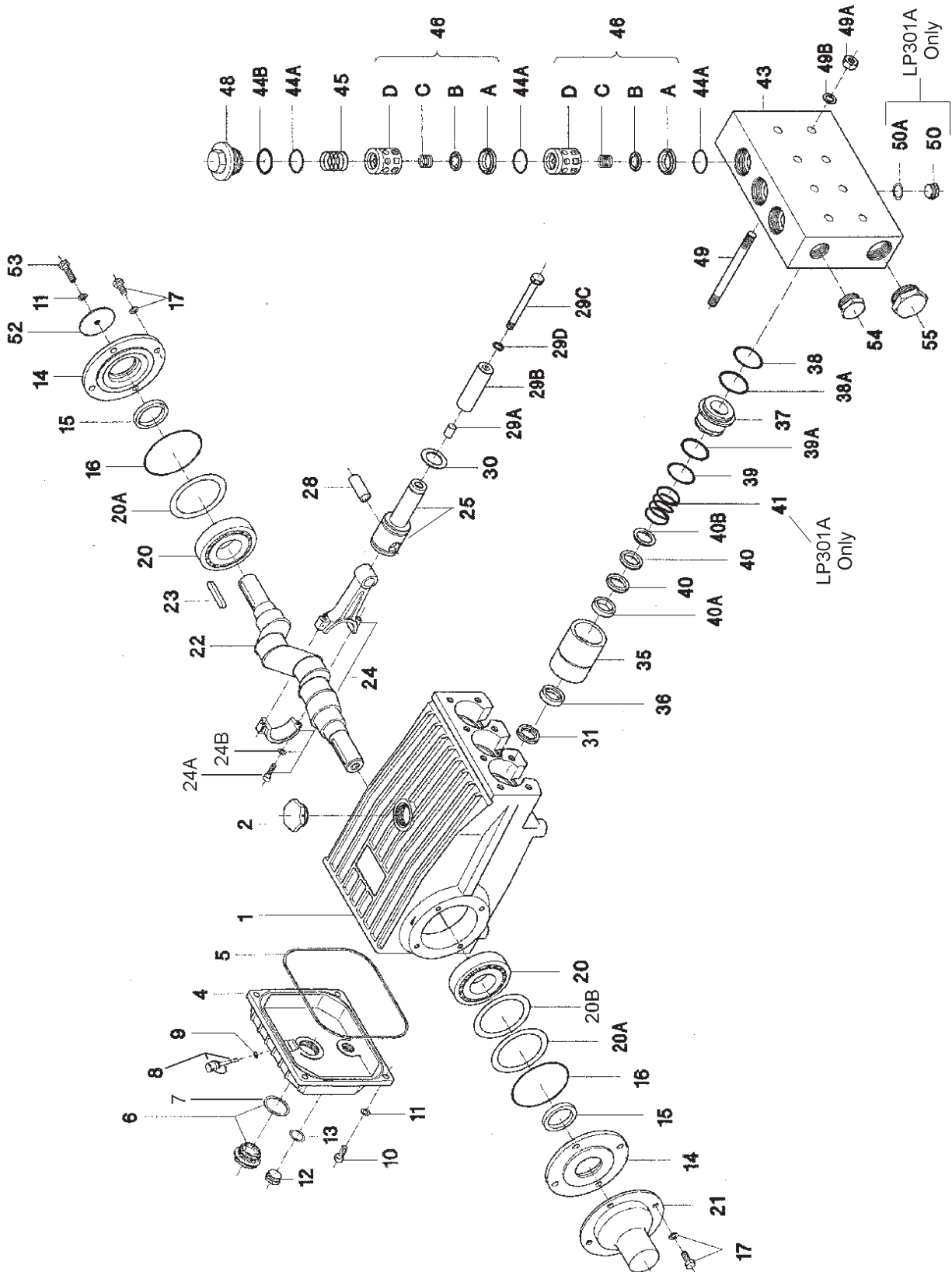

LP301A/LP600 PARTS LIST

ITEM	PART	DESCRIPTION	QTY	ITEM	PART	DESCRIPTION	QTY
1	07759	Crankcase	1	36	13238	Leakage Seal (LP301A)	3
2	13000	Oil Filler Plug Assy...	1	37	13239	Seal Case (LP600)	3
4	06085	Crankcase Cover	1	37	13240	Seal Case (LP301A)	3
5	07104	O-ring, Crankcase Cover	1	38	07140	O-Ring, Seal Case	3
6	07186	Oil Sight Glass w/Gasket	1	38A	13241	Support Ring for 38	3
7	07187	Gasket (For Sight Glass)	1	39	07141	O-Ring (LP600)	3
8	06086	Oil Dipstick Assy.	1	39	12055	O-Ring (LP301A)	3
9	01009	O-Ring, (For Dipstick)	1	39A	13036	Support Ring for 39 (LP600)	3
10	01010	Cylinder Screw	4	39A	07693	Support Ring for 39 (LP301A)	3
11	08094	Spring Ring	5	40	07322	V-Sleeve (LP600)	6
12	07109	Plug, G1/2"	1	40	06083	V-Sleeve (LP301A)	6
13	07182	Gasket	1	40A	07268	Pressure Ring (LP600)	3
14	07111	Bearing Cover	2	40A	13366	Pressure Ring (LP301A)	3
15	07112	Radial Shaft Seal	2	40B	07270	Support Ring for 40 (LP600)	3
16	07113	O-Ring for Bearing Cover	2	40B	13438	Guide Ring for 40 (LP301A)	3
17	07114	Hexagon Screw	8	41	07338	Pressure Spring (LP301A only)	3
20	07116	Taper Roller Bearing	2	43	13040	Valve Casing	1
20A	07117	Fitting Disc	1-3	44A	07150	O-Ring	9
20B	13001	Fitting Disc	1-3	44B	06266	Support Ring for O-Ring	3
21	07118	Shaft Protector	1	45	06078	Compression Spring	3
22	13242	Crankshaft	1	46	07067	Valve Assy., Complete (LP600)	6
23	13243	Woodruff Key	1	46	07060	Valve Assy., Complete (LP301A)	6
24	13340	Connecting Rod Assy.	3	46A	07064	Valve Seat	6
24A	13277	Inner Hex Screw	6	46B	13130	Valve Plate (LP600)	6
24B	13278	Spring Washer	6	46B	07063	Valve Plate (LP301A)	6
25	13341	Crosshead Assy.	3	46C	07062	Valve Spring	6
28	13232	Crosshead Pin	3	46D	07066	Spacer Pipe	6
29A	07125	Centering Sleeve	3	48	06077	Plug	3
29B	07126	Plunger Pipe (LP600)	3	49	07157	Stud bolt	8
29B	07127	Plunger Pipe (LP301A)	3	49A	07158	Hexagon Nut	8
29C	07131	Tensioning Screw	3	49B	07159	Disc	8
29D	07755	Copper Ring	3	50	12250	Plug, G-1/2", S.S. (LP301A only)	1
29D	07161-0100	Oil Seal	3	50A	13439	Steel Ring (LP301A only)	1
30	07779	Oil Scraper	3	52	13020	Disc for Crankshaft	1
31	07133*	Oil Seal	3	53	06607	Hexagon Screw	1
35	13235	Seal Sleeve (LP600)	3	54	13044	Plug, G 1"	2
35	13364	Seal Sleeve (LP301A)	3	55	13151	Plug, G 1-1/4"	2
36	13237	Leakage Seal (LP600)	3				

* This seal replaces former oil seal assembly (p/n 06120)

LP301A/LP600 REPAIR KITS

Plunger Packing Kits

LP301A # 09459

For pumps manufactured on or after 4/96

Item	Part #	Description	Qty.
36	13238	Leakage Seal	3
38	07140	O-Ring	3
38A	13241	Support Ring	3
39	12055	O-Ring	3
39A	07693	Support Ring	3
40	06083	V-Sleeve 6	
40A	13366	Pressure Ring	3

LP301A # 09198

For pumps manufactured before 4/96

Item	Part #	Description	Qty.
36	13238	Leakage Seal	3
38	07140	O-Ring	3
38A	13241	Support Ring	3
39	12055	O-Ring	3
39A	07693	Support Ring	3
40	13049	V-Sleeve 6	
40A	13366	Support Ring	3

LP600 # 09197

Item	Part #	Description	Qty.
36	13237	Leakage Seal	3
38	07140	O-Ring	3
38A	13241	Support Ring	3
39	07141	O-Ring	3
39A	13036	Support Ring	3
40	07322	V-Sleeve 6	
40A	07268	Pressure Ring	3

Valve Kits

LP301A # 09196

Item	Part #	Description	Qty.
46A	07064	Valve Seat	3
46B	07063	Valve Plate	3
46C	07062	Valve Spring	3
44A	07150	O-Ring	6
44B	06266	Support Ring	3

LP600 # 09195

Item	Part #	Description	Qty.
46A	07064	Valve Seat	3
46B	13130	Valve Plate	3
46C	07062	Valve Spring	3
44A	07150	O-Ring	6
44B	06266	Support Ring	3

Specifications Model LP600

Volume	Up to 9.7 GPM
Discharge Pressure	Up to 6000 PSI
Inlet Pressure	Up to 90 PSI
Speed	Up to 1000 RPM
Plunger Diameter	20 mm
Stroke	42 mm
Crankcase Oil Capacity	100 fl.oz.
Temperature of Pumped Fluids	Up to 140 °F
Inlet Port	1-1/4" BSP
Discharge Port	1" BSP
Crankshaft Mounting	Either Side
Shaft Rotation	Top of Pulley Towards Fluid End
Weight	110 lbs.
Crankshaft Diameter	35 mm

* Intermittent duty for pump speeds in excess of 805 RPM

PULLEY INFORMATION

Pulley selection and pump speed are based on a 1725 RPM motor and "B" section belts. When selecting desired GPM, allow for a ±5% tolerance on pumps output due to variations in pulleys, belts and motors among manufacturers.

1. Select GPM required, then select appropriate motor and pump pulley from the same line.
2. The desired pressure is achieved by selecting the correct nozzle size that corresponds with the pump GPM.

HORSEPOWER INFORMATION

We recommend that a 1.1 service factor be specified when selecting an electric motor as the power source. To compute specific pump horsepower requirements, use the following formula:

$$HP = (GPM \times PSI) / 1440$$

LP600 PULLEY SELECTION AND HORSEPOWER REQUIREMENTS							
GPM	PUMP PULLEY	MOTOR PULLEY	RPM	3000 PSI	4000 PSI	5000 PSI	6000 PSI
4.85	12.75"	3.95"	500	10.1	13.5	16.8	20.2
6.2	12.75"	4.95"	640	12.9	17.2	21.5	25.8
7.28	12.75"	5.75"	750	15.2	20.2	25.3	30.3
7.8	12.75"	6.15"	805	16.3	21.6	27.1	32.5
8.4	12.75"	6.55"	865	17.5	23.3	29.1	35.0
9.1	12.75"	6.95"	940	18.9	25.2	31.6	37.9
9.7	12.75"	7.50"	1000	20.2	26.9	33.7	40.4

LP301A/LP600 REPAIR INSTRUCTIONS

NOTE: Always take time to lubricate all metal and non-metal parts with a light film of oil before reassembling. This step will help ensure proper fit, at the same time protecting the pump non-metal parts (elastomers) from cutting and scoring.

TO CHECK VALVES



- 1) Loosen and remove tension plugs (48) with a 36mm socket wrench.

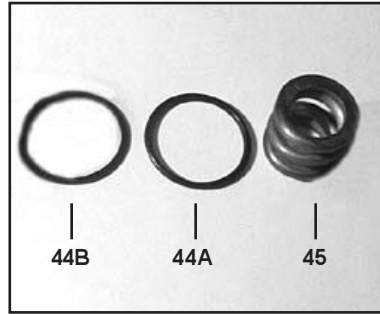

- 2) Remove the support ring (44B), o-ring (44A) and tension spring (45).



- 3) Take out discharge valve assemblies (46) by pulling them upwards out of the valve casing (43) with a snap-ring tongs or any other pull-off device. Then remove inlet valves in the same way.

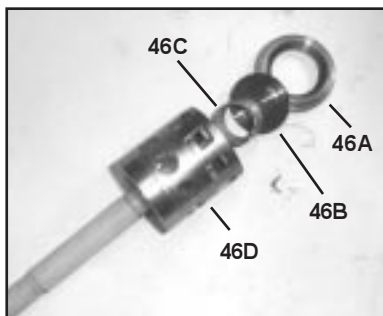

- 4) Loosen valve seats (46A) and valve spring (46C) from spacer pipe (46D) by lightly hitting the valve plate (46B) with a plastic stick. Check sealing surface and replace worn parts. Reassemble with new o-rings (44A) if possible and oil them before installing.



- 5) Tighten up tension plugs (48) to 107 ft.-lbs.

LP301A/LP600 REPAIR INSTRUCTIONS

NOTE: Always take time to lubricate all metal and non-metal parts with a light film of oil before reassembling. This step will help ensure proper fit, at the same time protecting the pump non-metal parts (elastomers) from cutting and scoring.

TO CHECK SEALS AND PLUNGER PIPE



- 6) Loosen the 8 nuts (49A) with a 19mm socket and pull off valve casing (43) to the front.



- 7) Remove the seal sleeve (35) from the manifold and /or crankcase.



- 8) Remove seal case (37) from seal sleeve (35).

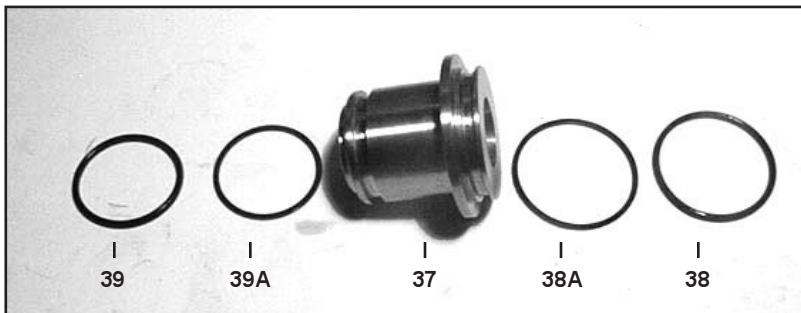

- 9) Check O-rings (39 & 38) and support rings (39A & 38A) on seal case (37).



- 10) Remove leakage seal (36) from the seal sleeve. If worn or damaged replace with new seal.

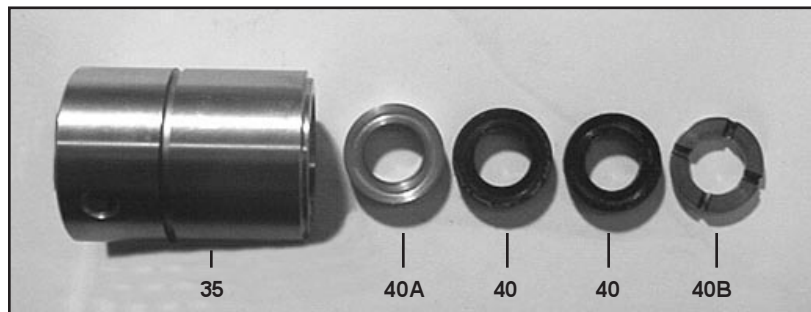

- 11) Remove the pressure ring (40A), v-sleeves (40), and support ring (40B), from the seal sleeve. For LP301A pumps, remove the pressure spring (41). Examine seals carefully and replace if worn. Clean surfaces of seal sleeves (35) which come in contact with the crankcase (1) and sealing surfaces of valve casing (43).

LP301A/LP600 REPAIR INSTRUCTIONS

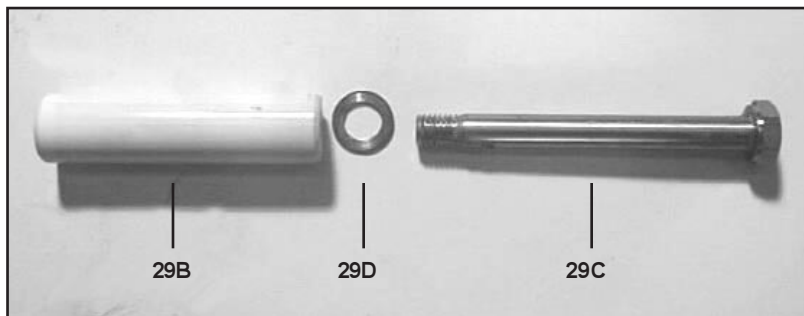

12) Check plunger surface (29B). If plunger pipe is worn out, loosen tension screws (29C) with a 15mm socket and pull off plunger pipe to the front. Clean front surface of plunger (29B) thoroughly. Apply a small drop of locktite to tension screw. Put a **new** crush washer (29D) onto tension screw. Put a thin coat of glue (Loctite) on the ring (or ceramic plunger side) and tighten screw to 265 in.-lbs.

13) Replace complete seal sleeve (35)/seal case (37) assembly into crankcase (1). Make sure that the weep hole points downward. **Note: To replace the oil seals (31), you will need to disassemble the gear end (see instructions below).**

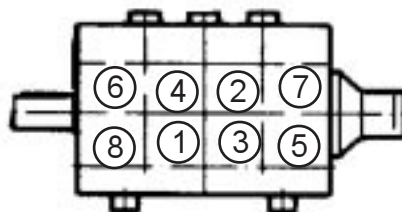
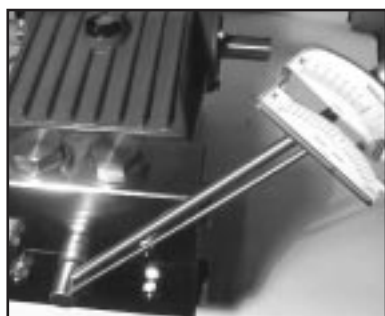

14) Place entire manifold/seal sleeve assembly over the studs and push firmly until seated against the crank-

case.
15) Tighten hex nuts (49A) in a crosswise pattern (shown above) to 59 ft.-lbs.

LP301A/LP600 REPAIR INSTRUCTIONS

TO DISMANTLE GEAR END

After removing valve casing (43) and plunger pipe (29B), drain the oil. Remove the gear cover (4) and both bearing covers (14). Loosen connecting rod screws (24A) and push the front of the connecting rod (24) forward as far as possible into the crosshead guide.

IMPORTANT! Connecting rods (24) are marked for identification. Do not twist connecting rod halves. Connecting rod is to be reinstalled in the same position on shaft journals.

Turning the crankshaft (22) slightly, hit it out carefully to the side with a rubber hammer.

IMPORTANT! Do not bend the connecting rod (24) shanks. Check crankshaft (22) and connecting rod (24) surfaces, radial shaft seals (15) and taper roller bearings (20).

To remove the oil seals (31) use a wooden rod and sharply hit down on the oil seals from the crankcase (1). Note: when replacing the oil seals, apply a small amount of locktight to the outside edges of each oil seal before re-inserting them into the crankcase.

To Reassemble

Using a soft tool, press in the outer bearing ring until the outer edge lines up with the outer edge of the bearing hole. Remove bearing cover (14) together with radial shaft seal (15) and o-ring (16). Fit crankshaft (22) through bearing hole on the opposite side. Press in outer bearing and tighten it inwards with the bearing cover, keeping the crankshaft in vertical position and turning slowly so that the taper rollers of the bearings touch the edge of the outer bearing ring. Adjust axial bearing clearance to at least 0.1mm and maximum 0.15mm by placing fitting discs (20A and 20B) under the bearing cover.

IMPORTANT! After assembly has been completed, the crankshaft should turn easily with very little clearance. Tighten connecting rod screws (24A) to 310 in.-lbs. Re-assemble the fluid end (see instructions above).

LP301A/LP600 TORQUE SPECIFICATIONS

<u>Position</u>	<u>Item#</u>	<u>Description</u>	<u>Torque Amount</u>
24A	13277	Inner Hex Screw, Connecting Rod	310 in.-lbs.
29C	07131	Tension Screw, Plunger	265 in.-lbs.
48	06077	Plug, Discharge	107 ft.-lbs.
49A	07158	Hexagon Nut, Stud Bolts	59 ft.-lbs.

Pump Mounting Selection Guide

<p>Bushings 06496 - 35 mm H Bushing</p>
<p>Pulley & Sheaves 07165 - 12.75" Cast Iron - 4 gr. AB Section</p>
<p>Rails 07357 - Plated Steel Channel Rails (L=11.75"xW=1.88"xH=3.00")</p>

PUMP SYSTEM MALFUNCTION

<u>MALFUNCTION</u>	<u>CAUSE</u>	<u>REMEDY</u>
The Pressure and/or the Delivery Drops	Worn packing seals Broken valve spring Belt slippage Worn or Damaged nozzle Fouled discharge valve Fouled inlet strainer Worn or Damaged hose Worn or Plugged relief valve on pump Cavitation pump for restrictions Unloader	Replace packing seals Replace spring Tighten or Replace belt Replace nozzle Clean valve assembly Clean strainer Repair/Replace hose Clean, Reset, and Replace worn parts Check suction lines on inlet of Check for proper operation
Water in crankcase	High humidity Worn seals	Reduce oil change interval Replace seals
Noisy Operation	Worn bearings Cavitation	Replace bearings, Refill crankcase oil with recommended lubricant Check inlet lines for restrictions and/or proper sizing
Rough/Pulsating Operation with Pressure Drop	Worn packing Inlet restriction Accumulator pressure Unloader Cavitation	Replace packing Check system for stoppage, air leaks, correctly sized inlet plumbing to pump Recharge/Replace accumulator Check for proper operation Check inlet lines for restrictions and/or proper size
Pump Pressure as gun Pressure	Restricted discharge plumbing	Re-size discharge plumbing to Drop at flow rate of pump Rated,
Excessive Leakage	Worn plungers Worn packing/seals Excessive vacuum Cracked plungers Inlet pressure too high	Replace plungers Adjust or Replace packing seals Reduce suction vacuum Replace plungers Reduce inlet pressure
High Crankcase Temperature	Wrong Grade of oil Improper amount of oil in crankcase	Giant oil is recommended Adjust oil level to proper amount

Preventative Maintenance Check-List & Recommended Spare Parts List						
Check	Daily	Weekly	50hrs	Every 500 hrs	Every 1500 hrs	Every 3000 hrs
Oil Level/Quality	X					
Oil Leaks	X					
Water Leaks	X					
Belts, Pulley		X				
Plumbing		X				
Recommended Spare Parts						
Oil Change (1 Gallon) p/n 1154			X	X		
Seal Spare Parts (1 kit/pump)					LP301A - p/n 09459 LP600 - p/n 09197	
Valve Spare Parts (1 kit/pump)						LP301A - p/n 09196 LP600 - p/n 09195

LP301A/LP600 DIMENSIONS (mm)

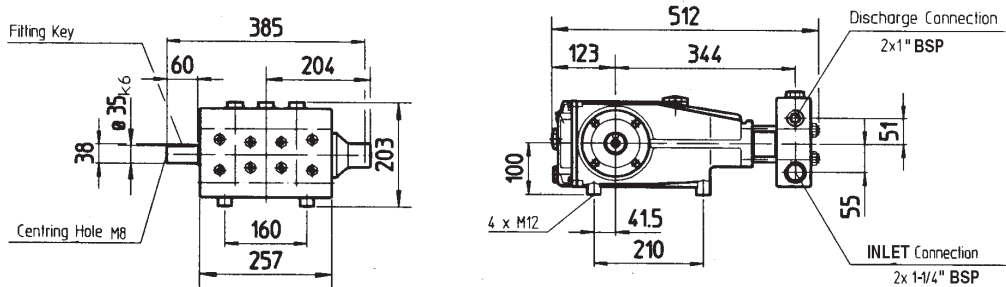

GIANT INDUSTRIES LIMITED WARRANTY

Giant Industries, Inc. pumps and accessories are warranted by the manufacturer to be free from defects in workmanship and material as follows:

1. For portable pressure washers and car wash applications, the discharge manifolds will never fail, period. If they ever fail, we will replace them free of charge. Our other pump parts, used in portable pressure washers and in car wash applications, are warranted for five years from the date of shipment for all pumps used in NON-SALINE, clean water applications.

2. One (1) year from the date of shipment for all other Giant industrial and consumer pumps.
3. Six (6) months from the date of shipment for all rebuilt pumps.
4. Ninety (90) days from the date of shipment for all Giant accessories.

This warranty is limited to repair or replacement of pumps and accessories of which the manufacturer's evaluation shows were defective at the time of shipment by the manufacturer. The following items are NOT covered or will void the warranty:

1. Defects caused by negligence or fault of the buyer or third party.
2. Normal wear and tear to standard wear parts.
3. Use of repair parts other than those manufactured or authorized by Giant.
4. Improper use of the product as a component part.
5. Changes or modifications made by the customer or third party.
6. The operation of pumps and or accessories exceeding the specifications set forth in the Operations Manuals provided by Giant Industries, Inc.

Liability under this warranty is on all non-wear parts and limited to the replacement or repair of those products returned freight prepaid to Giant Industries which are deemed to be defective due to workmanship or failure of material. A Returned Goods Authorization (R.G.A.) number and completed warranty evaluation form is required prior to the return to Giant Industries of all products under warranty consideration. Call (419)-531-4600 or fax (419)-531-6836 to obtain an R.G.A. number.

Repair or replacement of defective products as provided is the sole and exclusive remedy provided hereunder and the MANUFACTURER SHALL NOT BE LIABLE FOR FURTHER LOSS, DAMAGES, OR EXPENSES, INCLUDING INCIDENTAL AND CONSEQUENTIAL DAMAGES DIRECTLY OR INDIRECTLY ARISING FROM THE SALE OR USE OF THIS PRODUCT.

THE LIMITED WARRANTY SET FORTH HEREIN IS IN LIEU OF ALL OTHER WARRANTIES OR REPRESENTATION, EXPRESS OR IMPLIED, INCLUDING WITHOUT LIMITATION ANY WARRANTIES OR MERCHANTABILITY OR FITNESS FOR A PARTICULAR PURPOSE AND ALL SUCH WARRANTIES ARE HEREBY DISCLAIMED AND EXCLUDED BY THE MANUFACTURER.



GIANT INDUSTRIES, INC., 900 N. Westwood Ave., P.O. Box 3187, Toledo, Ohio 43607
PHONE (419) 531-4600, FAX (419) 531-6836, www.giantpumps.com
© Copyright 2002 Giant Industries, Inc.