



P.O. Box 342, Delavan, WI 53115
Phone: 1-800-365-6832
Fax: 1-800-526-3757
E-Mail: flotec@flotecpump.com
Web Site: http://www.flotecwater.com

OWNER'S MANUAL
Pitcher Pump

NOTICE D'UTILISATION
Pompe d'Amorçage

MANUAL DEL USUARIO
Bomba de Émbolo Buzo

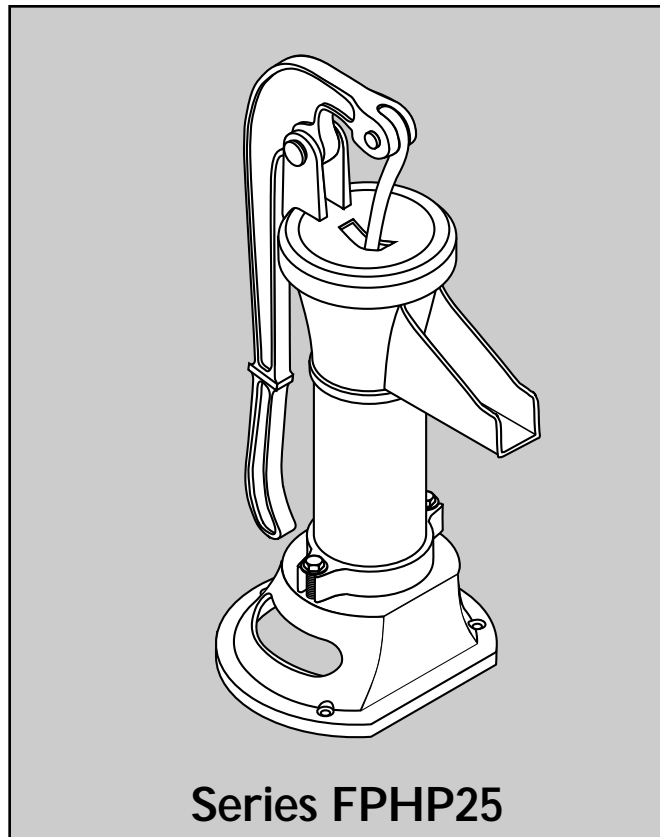

Water
is Our
Business™

Installation/Operation/Parts

*For further operating, installation,
or maintenance assistance:*

Call 1-800-365-6832

English Pages 2-4

Installation/Fonctionnement/Pièces

*Pour plus de renseignements
concernant l'utilisation,
l'installation ou l'entretien,*

Composer le 1 (800) 365-6832

Français Pages 5-7

Instalación/Operación/Piezas

*Para mayor información sobre el
funcionamiento, instalación o
mantenimiento de la bomba:*

Llame al 1-800-365-6832

Español Paginas 8-10

READ AND FOLLOW SAFETY INSTRUCTIONS!

 **This is the safety alert symbol.** When you see this symbol on your pump or in this manual, look for one of the following signal words and be alert to the potential for personal injury.

 **DANGER** warns about hazards that **will** cause serious personal injury, death or major property damage if ignored.

 **WARNING** warns about hazards that **can** cause serious personal injury, death or major property damage if ignored.

 **CAUTION** warns about hazards that **will** or **can** cause minor personal injury or property damage if ignored.

The label **NOTICE** indicates special instructions which are important but not related to hazards.

Carefully read and follow all safety instructions in this manual.

Do not allow pump to freeze. To do so will void warranty.

Pump water only with this pump.

Periodically inspect pump.

Wear safety glasses at all times when working on pumps.

Keep work area clean, uncluttered and properly lighted; store properly all unused tools and equipment.

Keep visitors and children at a safe distance from the work areas and open well heads.

ATTACH ORIGINAL RECEIPT HERE FOR WARRANTY CONSIDERATION.

Flotec Limited Warranty

Flotec warrants to the original consumer purchaser ("Purchaser") of its products that they are free from defects in material or workmanship.

If within twelve (12) months from the date of the original consumer purchase any such product shall prove to be defective, it shall be repaired or replaced at FLOTEC's option, subject to the terms and conditions set forth below. Your dated proof of purchase will be used to determine warranty eligibility.

Exceptions to the Twelve (12) Month Warranty

Ninety (90) Day Warranty:

If within ninety (90) days from original consumer purchase any Drill Pump, Pitcher Pump, or In-Line Water Filter Cartridge shall prove to be defective, it shall be replaced, subject to the terms set forth below.

Two (2) Year Warranty:

If within two (2) years from original consumer purchase any 1/3 HP Submersible Sump Pump shall prove to be defective, it shall be repaired or replaced at FLOTEC's option, subject to the terms and conditions set forth below.

Three (3) Year Warranty:

If within three (3) years from original consumer purchase any 4" Submersible Well Pump, or 1/2 HP Submersible Sump Pump, shall prove to be defective, it shall be repaired or replaced at FLOTEC's option, subject to the terms and conditions set forth below.

Four (4) Year Warranty:

If within four (4) years from original consumer purchase any Floodmate 6000™ Submersible Sump Pump shall prove to be defective, it shall be repaired or replaced at FLOTEC's option, subject to the terms and conditions set forth below.

Five (5) Year Warranty:

If within five (5) years from original consumer purchase any Pre-Charge water system tank shall prove to be defective, it shall be repaired or replaced at FLOTEC's option, subject to the terms and conditions set forth below.

General Terms and Conditions

Purchaser must pay all labor and shipping charges necessary to replace product covered by this warranty. This warranty shall not apply to acts of God, nor shall it apply to products which, in the sole judgement of FLOTEC, have been subject to negligence, abuse, accident, misapplication, tampering, alteration; nor due to improper installation, operation, maintenance or storage; nor to other than normal application, use or service, including but not limited to, operational failures caused by corrosion, rust or other foreign materials in the system, or operation at pressures in excess of recommended maximums.

Requests for service under this warranty shall be made by returning the defective product to the Retail outlet or to FLOTEC as soon as possible after the discovery of any alleged defect. FLOTEC will subsequently take corrective action as promptly as reasonably possible. No requests for service under this warranty will be accepted if received more than 30 days after the term of the warranty.

This warranty sets forth FLOTEC's sole obligation and purchaser's exclusive remedy for defective products.

FLOTEC SHALL NOT BE LIABLE FOR ANY CONSEQUENTIAL, INCIDENTAL, OR CONTINGENT DAMAGES WHATSOEVER.

THE FOREGOING WARRANTIES ARE EXCLUSIVE AND IN LIEU OF ALL OTHER EXPRESS WARRANTIES. IMPLIED WARRANTIES, INCLUDING BUT NOT LIMITED TO THE IMPLIED WARRANTIES OF MERCHANTABILITY AND FITNESS FOR A PARTICULAR PURPOSE, SHALL NOT EXTEND BEYOND THE DURATION OF THE APPLICABLE EXPRESS WARRANTIES PROVIDED HEREIN.

Some states do not allow the exclusion or limitation of incidental or consequential damages or limitations on how long an implied warranty lasts, so the above limitations or exclusions may not apply to you. This warranty gives you specific legal rights and you may also have other rights which vary from state to state.

FLOTEC • P.O. Box 342 • Delavan, WI U.S.A. 53115

Phone: 1-800-365-6832 • Fax: 1-800-526-3757

E-Mail: flotec@flotecpump.com • Web Site: <http://www.flotecwater.com>

INSTALLATION

Thread the pump into the top of the casing of a driven well or bolt it to the cover of a dug well.

NOTE: The base of the pump comes ready for use with a 1-1/4" pipe or it can be reduced with a bushing for use with a 1" pipe. Be certain there is a drop pipe extending down into the well water from the pitcher pump. The cap is adjustable for a wide range of handle positions.

Sealing Pipe Joints

Use only Teflon tape or Teflon based joint compounds for making all threaded connections to the pump itself. Make sure that all pipe joints in the suction pipe are air tight as well as water tight. *If the suction pipe can suck air, the pump will not be able to pull water from the well.*

Priming the Pump

CAUTION Never operate pump dry. Operating the pump without water may cause damage to the cup leather. ALWAYS fill pump with water before starting to pump.

NOTICE: The pump may need to be primed more than once before you can lift water. For best operation a foot valve should be installed at the bottom of the suction line.

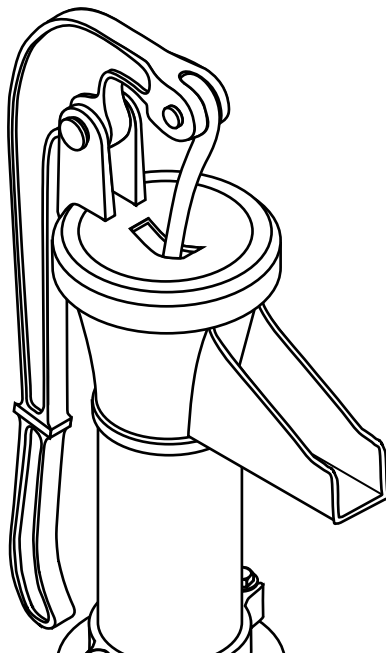

Figure 1: Prime the Pump

The pitcher pump must be primed before lifting water (Figure 1). Pour water in the top of the pitcher pump until it runs out of the spout. Wait 5 minutes until the cup leather swells enough to make contact with the pump wall. If necessary add more water.

MAINTENANCE

Replacing the Cup Leather

(Refer to the Exploded View, Page 4 for Key numbers)

- Step 1. Loosen the capscrew on the pump cap (Key No. 2) and lift the plunger assembly out of the pump.
- Step 2. Unscrew the cup leather holder (Key No. 7).
- Step 3. Remove old cup leather (Key No. 6), and put on new cup leather.
- Step 4. Screw leather cup holder back into original position.
- Step 5. Reinstall plunger assembly and cap (Key Nos. 1 through 7).
- Step 6. Insert capscrew and tighten.

Replacing the Valve Leather

(Refer to the Exploded View, Page 4 for Key numbers)

- Step 1. Remove one of the capscrews located at the base of the plunger body and loosen the other capscrew.
- Step 2. Remove the pump body (Key No. 8) from the pump base (Key No. 11).
- Step 3. Remove the check valve (Key No. 9) from the valve leather (Key No. 10).
- Step 4. Remove old valve leather. Clean any old leather off of column and base.
- Step 5. Position the raised end of check valve at the attached/hinged end of valve leather.
- Step 6. Reattach check valve to the valve leather with the screw, nut and washer.
- Step 7. Position new valve leather with check valve on base.
- Step 8. Reattach pump body to the base by reinstalling and tightening the capscrews, washers, and nuts.

**Thank you for purchasing
Flotec Products.**

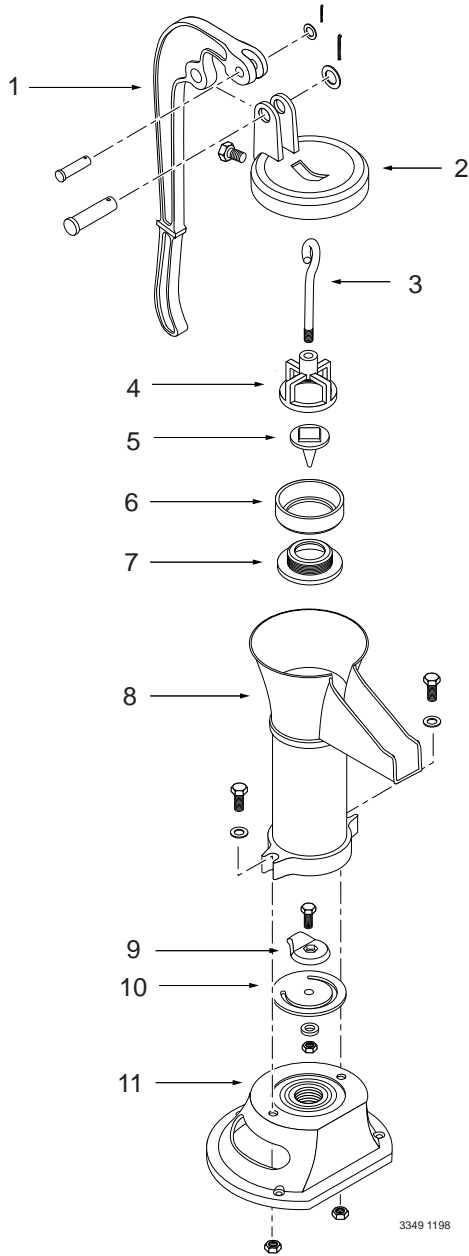

Model FPHP25

Key No.	Part Description	No. Used
1	Pump Handle	1
2	Pump Cap	1
3	Lift Rod	1
4	Plunger Valve Cage	1
5	Plunger Valve	1
6	Cup Leather *	1
7	Cup Leather Holder	1
8	Pump Body	1
9	Check Valve	1
10	Valve Leather *	1
11	Base	1

* Included with Part No. FPP0025

Troubleshooting

SYMPTOM	POSSIBLE CAUSE(S)	CORRECTIVE ACTION
Pump plunger moves but no water is delivered	Pump is not picking up prime Leak in suction side of pump Well is gaseous Intermittent over-pumping of well	Reprime pump. See "Priming Pump" in Owner's Manual. Suction pipe is sucking air. Check joints for leaks with soapy water. Consult factory about installing a sleeve in the well. Lower foot valve if possible. (Water drawn down below foot valve).