



# 290-2210 SERIES VACUUM PUMPING

**Features:**

- Up to 40GPM
- Pump Up to 60% Suspended Solids
- Self Priming Suction Lift to 25ft
- 23ft Discharge Head
- Low Shear, Low Emulsive Pumping
- Easy Maintenance

**Applications:**

- Grease Interceptors
- Oil, Water, Coolant Sump Draining
- Waste Slurry Transfers
- Pit Dewatering
- Marine / Recreational Pump-Outs
- Most Liquids with Suspended Solids
- Your Application ?



# General Construction:



## How It Works:

The rotary vane air pump creates a vacuum in the transfer cell. This vacuum will draw slurry into the stainless steel cell at up to 25ft. suction lift. When the tank is full it automatically pressurizes the cell discharging the slurry to drain at up to 23ft. discharge head. After the cell is discharged the cycle runs continually until manually shut off or the timered auto-off feature engages.

## Advantages:

The advantages of this design are the slurry never touches the pump, quiet operation, run dry capabilities, large solids to 1 1/2" dia. can be moved at considerable volumes, and one pump with several collection sites.



### Up to 25ft Suction Lift and 23ft Discharge Head

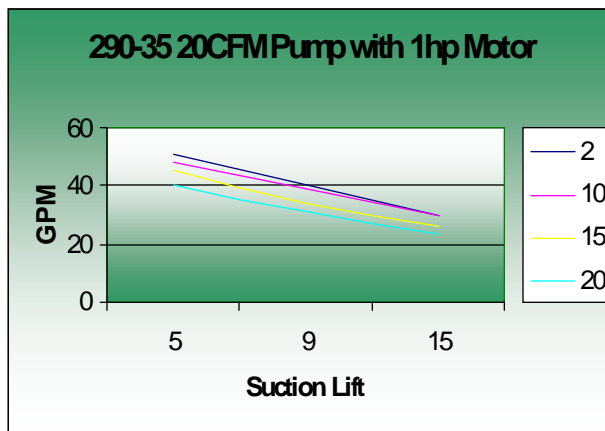
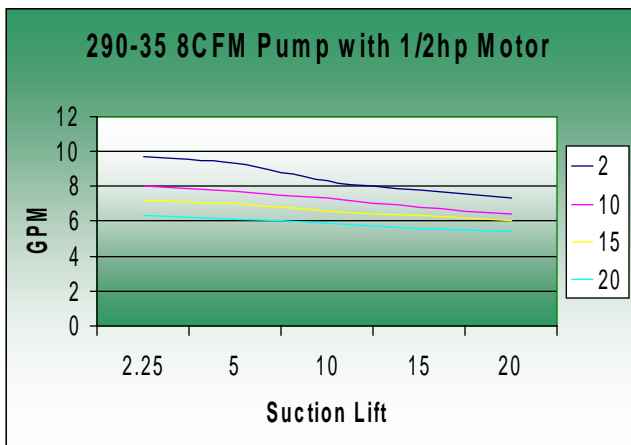

\*\*Other motor options are available including special electrical requirements.

# Vacuum Pump-Out Station 290-35-1HP

This Pump Out Station packages the 1hp vacuum pumping unit and 35 gallon transfer cell with other Edson products to provide an outstanding high performance pump out station for marina installations.

**290-35-1HP Pump Out Station** includes:

- 290-2210 Vacuum Pumping Unit
  - White Fiberglass Enclosure
  - Nema 4X Control Panel With Key Switch
  - Run Timer and 24V Start/Stop Safety Circuit
- 290-35-Tank Stainless Steel Transfer Cell
- 260-284 White Powder Coated Hose Stand
  - 100ft Hose Capacity
  - Start/Stop Circuit
- 261-25-150 Pump Out Hose Assembly 25ft x 1 1/2"ID.
  - 90° ball valve
  - set of (4) four deck / drain adapters
  - sightglass check valve



**290-35-1HP**

Shown with optional bronze hydrant

## Dimensional Information:

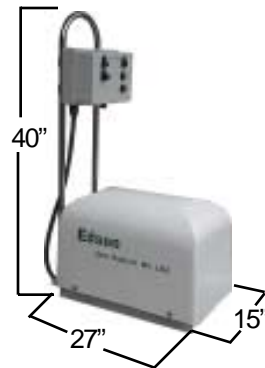

**Check Valve Material Options:** *Clear pvc check valve so you can see what is happening.*



Niytrile  
Viton

## Maintenance: *Its That Easy!!*

1. Inspect clear check valves for debris.



2. Check and maintain oil level .



Distances

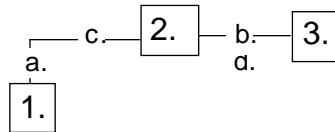

Legend  
 Elevation:  
 a. 23'  
 b. -2'  
 Horizontal:  
 c. 1000'  
 d. 200'

All dimensions are approximate.  
 Should **not** be used for Contractor estimating.

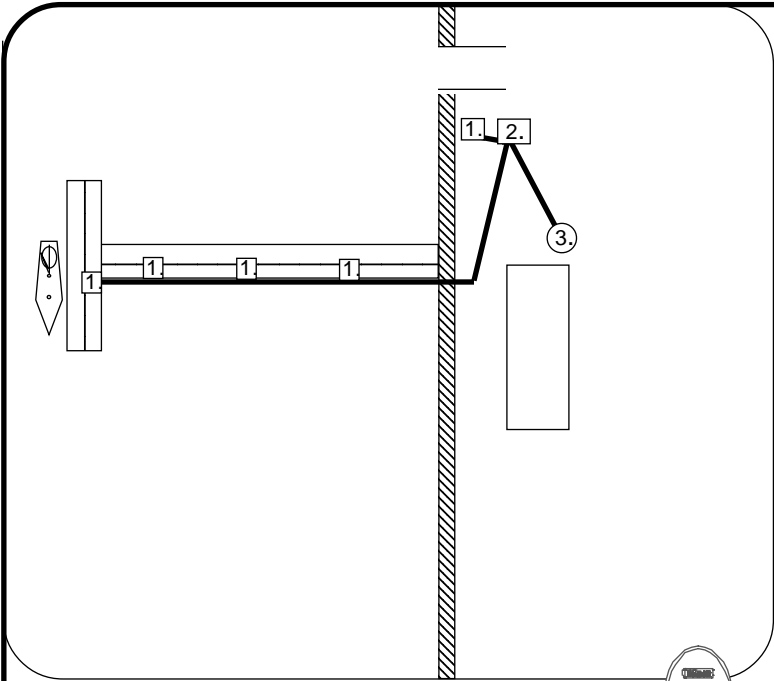

290-35-1HP  
 Shown With Optional Hydrant  
 270BR-150

2. Edson VacuMaster

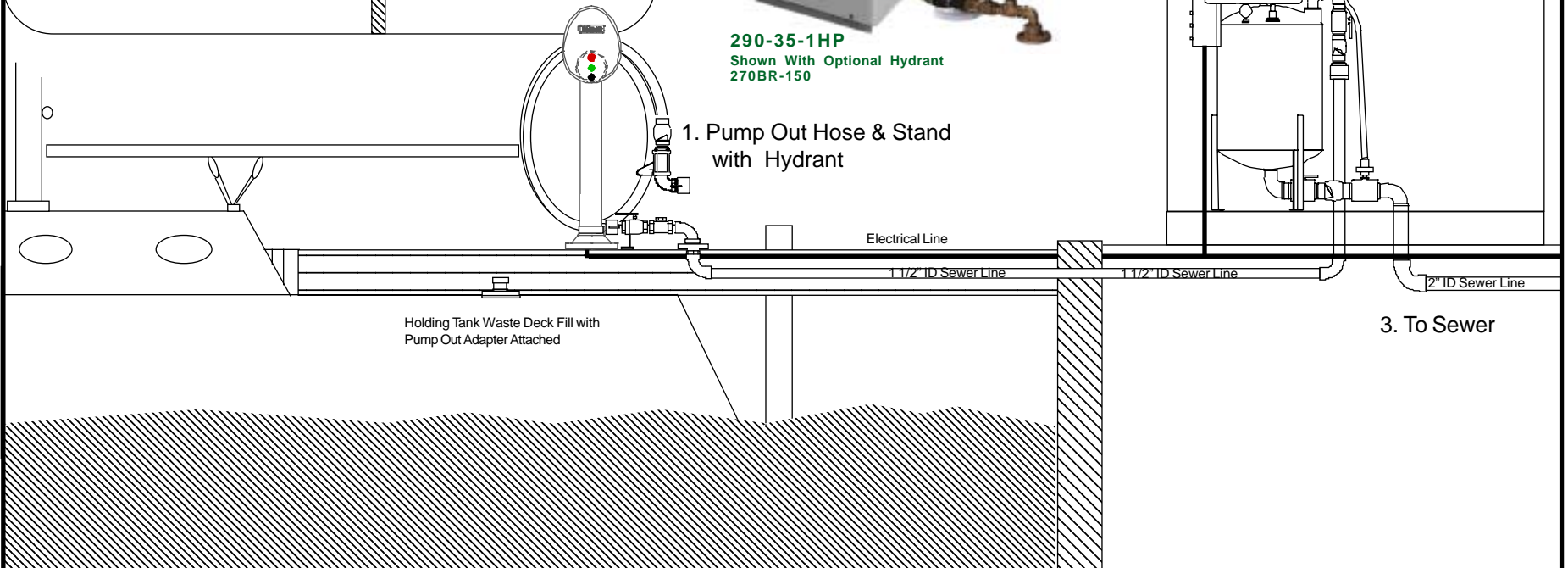
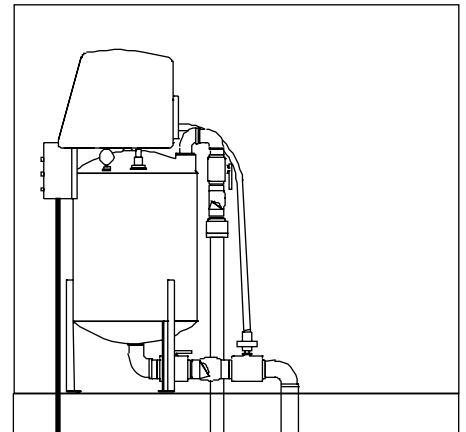

1. Pump Out Hose & Stand with Hydrant



146 Duchaine Blvd.  
 New Bedford, MA 02745  
 Tel:508-995-9711 Fax:508-995-5021

290-35-1HP Pump Out