

PISTON PUMP SERVICE MANUAL



3 FRAME: 280, 281, 290, 291

4 FRAME: 331, 333, 335, 430, 431, 435

5 FRAME: 323, 390

10 FRAME: 621, 623, 820, 821, 825, 1010, 1011, 1015

25 FRAME: 1520, 1521, 1525, 2520, 2521, 2525, 2520C

60 FRAME: 6020, 6021, 6024, 6040, 6041, 6044

INSTALLATION AND START-UP INFORMATION

Optimum performance of the pump is dependent upon the entire liquid system and will be obtained only with the proper selection, installation of plumbing, and operation of the pump and accessories.

SPECIFICATIONS: Maximum specifications refer to individual attributes. It is **not** implied that **all maximums** can be performed **simultaneously**. If more than one maximum is considered, check with your CAT PUMPS supplier to confirm the proper performance and pump selection. Refer to individual pump Data Sheet for complete specifications, parts list and exploded view.

LUBRICATION: Fill crankcase with special CAT PUMP oil per pump specifications [3FR-10 oz., 4FR-21 oz., 5FR-21 oz., 10FR-40 oz., 25FR-84 oz., 60FR-10 Qts.]. DO NOT RUN PUMP WITHOUT OIL IN CRANKCASE. Change initial fill after 50 hours running period. Thereafter, change oil every **3 months or 500 hour intervals**. [25FR, 60FR] **Oil adjustment** is vertical to start feed, horizontal to stop feed, 45° to drain reservoir. Additional lubrication may be required with increased hours of operation and temperature.

PUMP ROTATION: Pump was designed for forward rotation to allow optimum lubrication of the crosshead area. Reverse rotation is acceptable if the crankcase oil level is increased slightly above center dot to assure adequate lubrication.

PULLEY SELECTION: Select size of motor pulley required to deliver the desired flow from Horsepower Requirement and Pulley Selection Chart (refer to Tech Bulletin 003).

DRIVE SELECTION: The motor or engine driving the pump must be of adequate horsepower to maintain full RPM when the pump is under load. Select the electric motor from the Horsepower Requirement Chart according to required pump discharge flow, maximum **pressure at the pump** and drive losses of approximately 3-5%. Consult the manufacturer of gas or diesel engine for selection of the proper engine size.

MOUNTING: Mount the pump on a rigid, horizontal surface in a manner to permit drainage of crankcase oil. An uneven mounting surface will cause extensive damage to the pump base. To minimize piping stress, **use appropriate flexible hose to inlet and discharge ports**. Use the correct belt; make sure pulleys are aligned. Excessive belt tension may be harmful to the bearings. Hand rotate pump before starting to be certain shaft and bearings are free moving.

LOCATION: If the pump is used in extremely dirty or humid conditions, it is recommended pump be enclosed. Do not store or operate in excessively high temperature areas or without proper ventilation.

INLET CONDITIONS: Refer to complete **Inlet Condition Check-List** in this manual before starting system. DO NOT STARVE THE PUMP OR RUN DRY. Temperatures above 130°F are permissible. Add 1/2 PSI inlet pressure per each degree F over 130°F. Elastomer or RPM changes may be required. See Tech Bulletin 002 or call CAT PUMPS for recommendations.

C.A.T.: Installation of a C.A.T. (Captive Acceleration Tube) is recommended in applications with stressful inlet conditions such as high temperatures, booster pump feed, long inlet lines or quick closing valves.

DISCHARGE CONDITIONS: OPEN ALL VALVES BEFORE STARTING SYSTEM to avoid deadhead overpressure condition and severe damage to the pump or system.

Install a **Pulsation Dampening** device onto the discharge head or in the discharge line. Be certain the pulsation dampener (Prrrrr-o-lator) is properly precharged for the system pressure (refer to individual Data Sheet).

A **reliable Pressure Gauge** should be installed near the discharge outlet of the high pressure manifold. This is extremely important for adjusting pressure regulating devices and also for proper sizing of the nozzle or restricting orifice. The pump is rated for a maximum pressure; this is the **pressure** which would be **read at the discharge manifold of the pump**, NOT AT THE GUN OR NOZZLE.

Use PTFE thread tape or pipe thread sealant (sparingly) to connect accessories or plumbing. Exercise caution not to wrap tape beyond the last thread to avoid tape from becoming lodged in the pump or accessories. This condition will cause a malfunction of the pump or system.

PRESSURE REGULATION: All systems require both a primary pressure regulating device (i.e., regulator, unloader) and a secondary pressure safety relief device (i.e., pop-off valve, safety valve). The primary pressure device must be installed on the discharge side of the pump. The function of the primary pressure regulating device is to protect the pump from over pressurization, which can be caused by a plugged or closed off discharge line. Over pressurization can severely damage the pump, other system components and can cause bodily harm. The secondary safety relief device must be installed in-line between the primary device and pump on the discharge side of the manifold. This will ensure pressure relief of the system if the primary regulating device fails. Failure to install such a safety device will void the warranty on the pump.

If a large portion of the pumped liquid is by-passed (not used) when the high pressure system is running, this by-pass liquid should be routed to an adequately sized, baffled supply tank or to drain. If routed to the pump inlet, the **by-pass liquid can quickly develop excessive heat and result in damage to the pump**. A temperature control device to shut the system down within the pump limits or multiple THERMO VALVES must be installed in the by-pass line to protect the pump.

NOZZLES: A worn nozzle will result in loss of pressure. Do not adjust pressure regulating device to compensate. Replace nozzle and reset regulating device to system pressure.

PUMPED LIQUIDS: Some liquids may require a **flush between operations or before storing**. For pumping liquids other than water, contact your CAT PUMPS supplier.

STORING: For extended storing or between use in cold climates, drain all pumped liquids from pump and **flush with antifreeze solution to prevent freezing and damage** to the pump. DO NOT RUN PUMP WITH FROZEN LIQUID (refer to Tech Bulletin 083).

WARNING

All systems require both a primary pressure regulating device (i.e., regulator, unloader) and a secondary pressure safety relief device (i.e., pop-off valve, safety valve). Failure to install such relief devices could result in personal injury or damage to the pump or to system components. CAT PUMPS does not assume any liability or responsibility for the operation of a customer's high pressure system.

World Headquarters

CAT PUMPS

1681 - 94th Lane N.E. Minneapolis, MN 55449-4324

Phone (763) 780-5440 — FAX (763) 780-2958

e-mail: techsupport@catpumps.com

www.catpumps.com

International Inquiries

FAX (763) 785-4329

e-mail: intlsales@catpumps.com



The Pumps with Nine Lives

CAT PUMPS (U.K.) LTD.

1 Fleet Business Park, Sandy Lane, Church Crookham, Fleet

Hampshire GU52 8BF, England

Phone Fleet 44 1252-622031 — Fax 44 1252-626655

e-mail: sales@catpumps.co.uk

N.V. CAT PUMPS INTERNATIONAL S.A.

Heiveldekens 6A, 2550 Kontich, Belgium

Phone 32-3-450.71.50 — Fax 32-3-450.71.51

e-mail: cpi@catpumps.be www.catpumps.be

CAT PUMPS DEUTSCHLAND GmbH

Buchwiese 2, D-65510 Idstein, Germany

Phone 49 6126-9303 0 — Fax 49 6126-9303 33

e-mail: catpumps@t-online.de www.catpumps.de



CAUTION: Before commencing with service, shut off drive (electric motor, gas or diesel engine) and turn off water supply to pump. Relieve all discharge line pressure by triggering gun or opening valve in discharge line.

After servicing is completed, turn on water supply to pump, start drive, reset pressure regulating device and secondary valve, read system pressure on the gauge at the pump head. Check for any leaks, vibration or pressure fluctuations and resume operation.

SERVICING THE VALVE ASSEMBLIES

Disassembly

1. Remove the two (2), four (4) or eight (8) Hex Flange Nuts securing the Discharge Manifold to the crankcase of the pump.
2. Support the Discharge Manifold and tap from the backside with soft mallet. Gradually work free from Cylinders.
3. Valve assemblies will remain in the Manifold. **Pump models with the o-ring groove on the outside of the valve seat require the assistance of a Reverse Pliers Tool to remove the valve seat.** The Valve, Spring and Retainer will then fall out when the Manifold is inverted.

Pump models without the o-ring groove on the outside of the Valve Seat permit the Seat, Valve, Spring and Retainer all to fall out when Manifold is inverted.

Reassembly

1. Examine Retainer for wear and replace as needed. Place Retainer in manifold chamber with nylon tab down.
2. Examine Spring for fatigue and replace as needed. Insert Spring into center of Retainer.
3. Inspect the Valves for wear, ridges or pitting and replace as needed.

NOTE: Seating side of Flat Valves may be lapped on flat surface using 240 grit paper. Quiet Valves due to their shape must be replaced. Insert Valve over Spring with dimpled side up.

NOTE: Do not mix Quiet Valve and Flat Valve Assemblies.

4. Examine Valve Seats for wear, pitting or grooves. Lap the **Flat Valve Seats** with 240 grit paper or replace if evidence of excessive wear. **Quiet Valve Seats** must be replaced if worn. Install Seats with **dishside down**.

5. Examine O-Rings and Back-up-Rings on the Valve Seat if used and replace if worn. Always lubricate O-Rings for ease of installation and to avoid damage.

NOTE: First install O-Ring in groove on seat towards seating surface, then Back-up-Ring.

NOTE: Models without outer groove on seat require the O-Ring to be placed on lip of retainer.

NOTE: On Model 390, examine O-Rings on Discharge Valve Adapter and replace if cut or worn. Lubricate O.D. of Adapter O-Rings and press Adapter into Discharge Manifold.

6. Install O-Ring, then Back-up-Ring on exposed Cylinder. **Back-up-Rings go to low pressure side of the O-Rings.** Lubricate O-Rings and Back-up-Rings on exposed Cylinder. Exercise caution when slipping Manifold over Cylinders to avoid damaging Cylinder O-Rings. Completely press Manifold over Cylinders.

NOTE: On Model 390, Discharge Valve Adapter will press into Cylinders when Manifold is reassembled to crankcase.

7. Replace two (2), four (4) or eight (8) Hex Flange Nuts and torque per chart.

NOTE: Replace all original Shims if used. When new manifold is used reshim pump. When starting the pump, check to see that there is no Cylinder motion as this will cause premature failure of the cylinder O-Rings. Center Cylinder motion indicates improper shimming. Refer to Tech Bulletin 017 for more information.

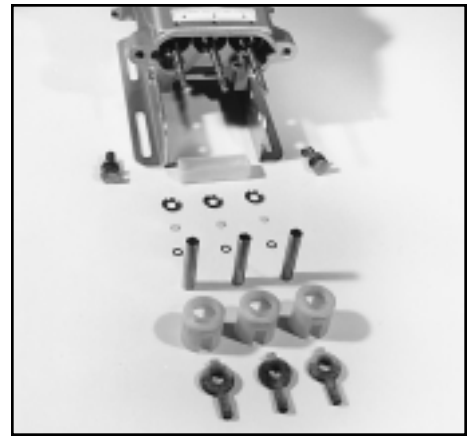

SERVICING THE PUMPING SECTION

■ Standard Piston Pump

Disassembly

1. Remove the Discharge Manifold as described in Servicing the Valve Assemblies section.
2. Grasp Cylinders by hand and with an up and down motion, pull Cylinders from Inlet Manifold.

(Model 390) When removing the Discharge Manifold to service the Piston Assemblies, the Discharge Adapters will generally remain in the discharge ports of the manifold. They can be easily removed with a pliers. Examine the adapter O-Rings and replace if worn or cut. Lubricate the O-Rings and outer surface of the adapters for ease of installation. Install the **smaller diameter, long extension** of the adapter into the discharge manifold ports.

3. Remove Cotterpin, Nut and Washer from Piston Rod.
4. Remove Retainer, Spacer, Piston-Cup Assembly and Inlet Valve.

(Model 390) After removing the Inlet Valve, the Inlet Adapters will be visible in the inlet manifold ports. Remove the Adapters with a pliers. Examine the O-Rings and replace if worn or cut. Lubricate the O-Rings and outer surface of the adapter for ease of installation. Install the **smaller diameter, long extension** of the adapter into the inlet manifold ports.

Reassembly

1. Examine Inlet Valve surface for pitting, scale or grooves. Reverse Valve and sand inlet side of Valve using 240 grit paper for clean surface or replace if evidence of excessive wear. Slip onto Rod.
2. Examine Piston seating surface and lightly sand on flat surface using 240 grit paper. If extreme pitting or sharp edges are present, replace Piston.

3. Examine Cup for wear, cracking, tearing or separation from the Piston. If worn replace and lubricate before installing on Piston.

Note cup installation: Wipe cup inserter with oil. Slip bac-cup Ring (when used) onto piston. Push Cup over inserter and square with all surfaces. Faulty Cup installation causes premature Cup failure. Some models use a one-piece Piston Assembly. The Cup does not separate from the Piston. Replace entire assembly. Lubricate Piston Assembly and slip Piston-Cup assembly onto Piston Rod with **lip facing discharge**.

4. Replace Piston Spacer and Retainer on Rod.
 5. Replace Washer, thread on Nut and torque per chart.
- NOTE: Always replace with new stainless steel Cotterpin and turn ends under.**
6. Examine Cylinder walls for scoring or etching which causes premature wear of Cups and replace as needed.
 7. Lubricate Cylinder and replace O-Rings and/or Back-up-Rings if worn or damaged. **Back-up-Rings go to low pressure side of the o-rings.** Carefully slip Cylinder over Rod Ends and push into Inlet Manifold with **Back-up-Rings facing the discharge manifold**.
 8. Position Discharge Manifold onto pump as described, replace fasteners and torque per chart.

SERVICING THE PUMPING SECTION

■ Sleeved-Type Piston Models

Disassembly

Models 6024-6044 have special cylinder adapters, sleeved-type pistons and V-packings instead of piston-cup assemblies.

1. After removing the Discharge Manifold, slip Cylinders off Piston Rods. It is best to leave the Cylinder Adapters and Springs in the Inlet Manifold as they may score the sleeved-type Pistons when removed. The V-packings will remain in the Cylinders.
2. Press worn V-packings from Cylinders.
3. Remove Cotterpins, Slotted Nuts, Washers and Piston Retainers. Pull sleeved-type Pistons from each Piston Rod. Next slip sleeved-type Spacer and Inlet Valve from each Piston Rod.
4. Lubricate and install new O-Rings on Cylinders and Adapters.
5. Inspect Inlet Valve surfaces. If Inlet Valves are worn, lap with 240 grit paper or replace if evidence of excessive damage. If sleeved-type piston inlet surface is worn or the outer diameter is scored, replace it.

Reassembly

1. First install Inlet Valve then sleeved-type Piston onto piston Rod with the **lapped end toward the inlet valve**.
2. Install the sleeved-type Spacer.
3. Install new V-packings in the Cylinder in the following order:
 - a. Install all parts in one Cylinder, then move to the next Cylinder.
 - b. Rotate Crankshaft to extend one Piston Rod completely forward.
 - c. Lubricate V-packings and Cylinder I.D. and place **O-ring end of cylinder on work surface**.
 - d. Install into Cylinder Female Packing Spacer, black Female Adapter, V-packings, nylon Male Adapter and **Male Packing Spacer with "V" side down**.
 - e. Install Spring in outer end of Cylinder and slip Cylinder Assembly over Piston Rod end. Press Cylinder into manifold chamber. The Spring in the Cylinder will be in your palm as the Cylinder Assembly is installed. Use the Spring to hold parts in Cylinder as it is slid over Piston Rod.
4. Remove Spring from Cylinder, install Retainer, conical Washer, Slotted Nut and torque per chart.
5. Install new Cotterpin and bend ends back.
6. Replace Spring in Cylinder.
7. Lubricate inlet and discharge ends of adapter and install Back-up-Rings first, then O-Rings onto adapter. Lubricate O. D. of **small diameter inlet end** of adapter and press into Cylinder.

8. Rotate Crankshaft to extend new Piston Rod. Proceed as above with second and third Cylinders. Proceed with standard Piston Pump Servicing.

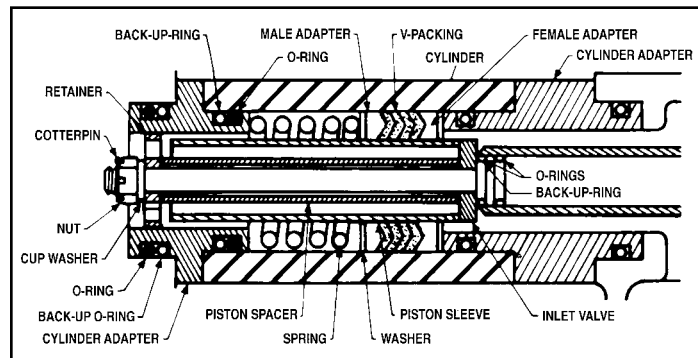

■ Hi-Temp Models

Before installing the Inlet Valve in the Model 2520C, be certain the **spacer is installed first**, then proceed with standard Inlet Valve, Roulon Piston Assembly, Piston Spacer, Piston Retainer, Washer, Nut and Cotterpin.

SERVICING SLEEVES AND SEALS

Disassembly

1. Remove Discharge Manifold and Piston Assemblies as described.
2. Remove Inlet Manifold containing seals.
3. Grasp Sleeves and with a pulling and twisting motion remove the Sleeve from the Piston Rod.

NOTE: Grasp Sleeve with pliers only if replacing worn Sleeves, as the procedure will mar the Sleeves.

4. Remove Seal Retainer.
5. Remove and examine O-Rings and/or Back-up-Rings on Piston Rod for wear and replace as needed.

Reassembly

1. Visually inspect that Barrier-Slinger is in position.
2. Lubricate new O-Rings and/or Back-up-Rings and slip onto Piston Rod. Install the first O-Ring (A) in the groove on the Piston Rod. Next position Back-up-Ring (B) against the stepped shoulder. Then install the second O-Ring (C). Exercise caution as you slip the O-Ring over the thread end of the Piston Rod.

NOTE: The Model 390 pump does not have a sleeve Back-up-Ring and has only one sleeve O-Ring which is installed in the groove on the Piston Rod (A).

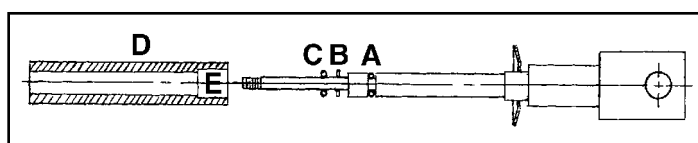

3. Examine Sleeves for scoring or etching and replace. **Immerse sleeves (D) in oil and carefully twist and push sleeve onto rod with machined counter bore end first (E).**
4. Install Seal Retainers. If Wicks are used, replace Wicks, thoroughly saturate with oil, place in Seal Retainer and install retainer.
5. Place Inlet Manifold on pair of clearance blocks with **crankcase side down** and drive out old seals.
6. Invert Inlet Manifold with **crankcase side up** and install new Seals. Lubricate O.D. of Seal and install Prrrrm-A-Lube Seal with **garter spring down**. If using blue dot seal, install **blue dot** seal facing up.

NOTE: When using alternate materials, the fit of the special materials may be snug and require gently driving the LPS into position with a cylinder of the same diameter to assure a square seating and no damage to the LPS.

NOTE: 25FR and 60FR do not have Prrrrm-A-Lube option. Install with spring down.

7. Slip lubricated Seal inserters onto Piston Rod ends, position Inlet Manifold onto pump and remove Seal inserters. Some models secure Inlet Manifold to crankcase. Replace fasteners and torque per chart.
8. Reassemble Piston Assemblies and Discharge Manifold as described.
9. Replace original quantity of Shims on each stud before replacing Discharge Manifold. Refer to Tech Bulletin 017.

■ Hi-Temp Models

On the Model 2520C series, the Seal with the lip, the adapter and the Seal with grease pocket can be driven from the Inlet Manifold.

To install a new Seal assembly, place Manifold on work surface with **crankcase side up**. Install **new seal with lip** in chamber with **garter spring down**. Next examine O-Ring and Adapter and replace either if worn. Lubricate outer surface of Adapter and install new O-Ring. Press Adapter into chamber, **smaller diameter end first**. Next install **grease pocket seal with garter spring down**. Then proceed with standard reassembly of pump.



The hi-temp models also have a special vented **Inlet Valve Spacer (A)** Following the installation of the Piston Rod O-Rings (B) and Sleeve (C), slip this vented Spacer onto the Rod with the **tapered end forward**. Then install O-Ring (D) in the tapered groove and proceed with standard Piston Assembly.

SERVICING CRANKCASE SECTION

1. While Inlet Manifold, Sleeves and Seal Retainers are removed, examine Crankcase Seals for wear.
2. Check oil for proper level and for evidence of water in the oil. Change crankcase oil on a regular schedule. See Preventative Maintenance Check-List.
3. Rotate Crankshaft by hand to feel for smooth bearing movement.
4. Examine Crankshaft Oil Seal externally for drying, cracking or leaking.
5. Consult your local CAT PUMPS supplier if Crankcase Service is required.

TORQUE SEQUENCE

4 BOLT MFLD

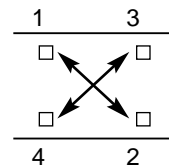

8 BOLT MFLD

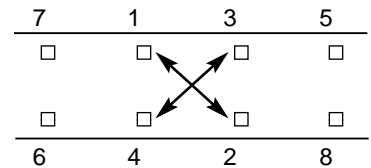

PREVENTATIVE MAINTENANCE CHECK-LIST

Check	Daily	Weekly	50 hrs.	500 hrs.*	1500 hrs.**	3000 hrs.**
Clean Filters	x					
Oil Level/Quality	x					
Oil Leaks	x					
Water Leaks	x					
Belts, Pulley		x				
Plumbing		x				
Initial Oil Change			x			
Oil Change				x		
Seal Change					x	
Valve Change						x
Accessories					x	

- * If other than CAT PUMPS special multi-viscosity ISO68 oil is used, change cycle should be every 300 hours.
- ** Each system's maintenance cycle will be exclusive. If system performance decreases, check immediately. If no wear at 1500 hours, check again at 2000 hours and each 500 hours until wear is observed. Valves typically require changing every other seal change. Duty cycle, temperature, quality of pumped liquid and inlet feed conditions all effect the life of pump wear parts and service cycle.
- ** Remember to service the regulator/unloader at each seal servicing and check all system accessories and connections before resuming operation.

TORQUE CHART

Pump Item Pump Model	Thread	Tool Size [P/N]	in. lbs.	ft. lbs.	Nm
PISTON ROD NUT					
284.....	M4	M8 Hex [25052]	25	2.0	3
280, 290, 323, 333, 390, 430, 10 FR	M6	M10 Hex [25082]	55	4.4	6
1020, 1520, 2020.....	M7	M10 Hex [25082]	115	9.4	13
25 FR.....	M8	M13 Hex [25324]	115	9.4	13
6020, 6040.....	M14	M24 Hex [44046]	390	32.5	44
6024, 6044.....	M10	M17 Hex [25083]	220	18.1	25
MANIFOLD STUD/NUT AND CYLINDER BOLTS					
280, 284, 290, 323, 333, 390, 430	M8	M12 Hex	115	9.4	13
10 FR.....	M10	M17 Hex [25083]	220	18.1	25
25 FR.....	M12	M19 Hex	350	28.9	39
6020, 6024, 6040, 6044	M16	M24 Hex [44046]	565	47.0	64
BUBBLE OIL GAUGE					
.....	M28	Oil Gauge Tool [44050]	45	3.6	5
MOUNTING SCREWS					
280, 290, 333, 430.....	M8	M13 Hex [25324]	100-115	8.3-9.5	12-13
520, 623, 820, 1010.....	M10	M17 Hex [25083]	205	17.1	24
25 FR.....	M12	M19 Hex	285-345	23.7-28.8	34-40
CONNECTING ROD SCREWS					
3 FR, 4 FR, 5 FR.....	M7	M10 Hex [25082]	95	7.96	11
10 FR, 25 FR.....	M8	M13 Hex [25324]	130	10.8	15
60 FR.....	M10	M17 Hex [25083]	390	32.5	44

TECHNICAL BULLETIN REFERENCE CHART

No.	Subject	Models
001	Long to Short Cylinders	10FR
002	Inlet Pressure VS Liquid Temperature	All Models
003	Power Unit Drive Packages	3PFR - 68PFR, 10FR - 60FR
005	"B" Manifold and Stepped Valve Seat	10FR
008	Motor Pulley Selection Chart	3PFR - 15PFR, 3FR - 25FR
009	Piston Rod and Seal	25FR
012	Sleeve-Type Piston Pump V-Packing Inserters	3FR, 4FR, 10FR, 25FR, 60FR
016	Bac-Cup Piston Assemblies	290, 323, 333, 430, 623
017	Shimming of Discharge Manifolds	3FR, 4FR, 10FR, 25FR
020	Quiet Valve Kits	280, 333, 430, 623, 820, 1010
021	Piston Rod, Sleeve and Seal	1020, 1520, 2020, 2520
024	Lubrication of Lo-Pressure Seals	All Models
025	Four Screw Crankcase Cover	333 and 430
026	Threaded Style Oil Gauge and Crankcase Cover	280, 290, 333, 430, 10FR
030	Flanged Nut Discharge Manifold	280, 323, 333, 390, 430
033	Crankcase and Rear Cover	270, 279, 280, 290
034	Servicing Crankcase Section	3FR, 4FR, 10FR, 25FR
036	Cylinder and Plunger Reference Chart	All Models
037	Machined Piston Assembly	323, 333, 623
038	Blue Dot Seal and Wick	323, 4FR, 10FR
039	Flat Valves VS Quiet Valves	390
042	Four Screw Crankcase Cover	623, 820, 1010
063	Hi-Temp, Cooled Inlet Renamed	2520C
064	By-Pass Hose Sizing	All Unloaders/Regulators
074	Torque Chart	Piston and Plunger Pumps
077	Oil Drain Kit	All Models (except 2SF/4SF)
084	Eye-Bolt Relocation	60FR, 60PFR, 68PFR

INLET CONDITION CHECK-LIST

Review Before Start-Up

Inadequate inlet conditions can cause serious malfunctions in the best designed pump. Surprisingly, the simplest of things can cause the most severe problems or go unnoticed to the unfamiliar or untrained eye. REVIEW THIS CHECK-LIST BEFORE OPERATION OF ANY SYSTEM. Remember, no two systems are alike, so there can be no ONE best way to set-up a system. All factors must be carefully considered.

INLET SUPPLY should exceed the maximum flow being delivered by the pump to assure proper performance.

- Open inlet shut-off valve and turn on water supply to avoid starving pump. **DO NOT RUN PUMP DRY.**
- Temperatures above 130°F are permissible. Add 1/2 PSI inlet pressure per each degree F over 130°F. Elastomer or RPM changes may be required. See Tech Bulletin 002 or call CAT PUMPS for recommendations.
- Avoid closed loop systems especially with high temperature, ultra-high pressure or large volumes. Conditions vary with regulating/unloader valve.
- Low vapor pressure liquids, such as solvents, require a booster pump and C.A.T. to maintain adequate inlet supply.
- Higher viscosity liquids require a positive head and a C.A.T. to assure adequate inlet supply.
- Higher temperature liquids tend to vaporize and require positive heads and C.A.T. to assure adequate inlet supply.
- When using an inlet supply reservoir, size it to provide adequate liquid to accommodate the maximum output of the pump, generally a minimum of 6-10 times the GPM (however, a combination of system factors can change this requirement); provide adequate baffling in the tank to eliminate air bubbles and turbulence; install diffusers on all return lines to the tank.

INLET LINE SIZE should be adequate to avoid starving the pump.

- Line size must be a minimum of one size larger than the pump inlet fitting. Avoid tees, 90 degree elbows or valves in the inlet line of the pump to reduce the risk of flow restriction and cavitation.
- The line **MUST** be a FLEXIBLE hose, NOT a rigid pipe, and reinforced on SUCTION systems to avoid collapsing.
- The simpler the inlet plumbing the less the potential for problems. Keep the length to a minimum, the number of elbows and joints to a minimum (ideally no elbows) and the inlet accessories to a minimum.
- Use pipe sealant to assure air-tight, positive sealing pipe joints.

INLET PRESSURE should fall within the specifications of the pump.

- Acceleration loss of liquids may be increased by high RPM, high temperatures, low vapor pressures or high viscosity and may require pressurized inlet and C.A.T. to maintain adequate inlet supply. **DO NOT USE C.A.T. WITH SUCTION INLET.**
- Optimum pump performance is obtained with +20 PSI (1.4 BAR) inlet pressure and a C.A.T. for certain applications. With adequate inlet plumbing, most pumps will perform with flooded suction. Maximum inlet pressure is 40 PSI (2.8 BAR). Negative suction up to -8.5 PSI (-0.5 BAR) can be achieved with optimum plumbing conditions.
- After prolonged storage, pump should be rotated by hand and purged of air to facilitate priming. Disconnect the discharge port and allow liquid to pass through pump and measure flow.

INLET ACCESSORIES are designed to protect against overpressurization, control inlet flow, contamination or temperature and provide ease of servicing.

- A shut-off valve is recommended to facilitate maintenance.
- Installation of a C.A.T. is essential in applications with stressful conditions such as high temperatures, booster pump feed or long inlet lines. **Do not use C.A.T. with negative inlet pressure.**
- A stand pipe can be used in some applications to help maintain a positive head on the pump inlet line.
- Inspect and clean inlet filters on a regular schedule to avoid flow restriction.
- A pressure gauge is recommended to monitor the inlet pressure and should be mounted **AS CLOSE TO THE PUMP INLET** as possible. **Short term, intermittent cavitation will not register on a standard gauge.** A pressure transducer is necessary to accurately read inlet pressure.
- All accessories should be sized to avoid restricting the inlet flow.
- All accessories should be compatible with the solution being pumped to prevent premature failure or malfunction.
- Optional inlet protection can be achieved by installing a pressure cut off switch between the inlet filter and the pump to shut off pump when there is no positive inlet pressure.

BY-PASS TO INLET Care should be exercised when deciding the method of by-pass from control valves.

- It is recommended the by-pass be directed to a baffled reservoir tank, with at least one baffle between the by-pass line and the inlet line to the pump.
- Although not recommended, by-pass liquid may be returned to the inlet line of the pump if the system is properly designed to protect your pump. When a pulsation dampener is used, a **PRESSURE REDUCING VALVE** must be installed on the inlet line (**BETWEEN THE BY-PASS CONNECTION AND THE INLET TO THE PUMP**) to avoid excessive pressure to the inlet of the pump. It is also recommended that a **THERMO VALVE** be used in the by-pass line to monitor the temperature build-up in the by-pass loop to avoid premature seal failure.
- A reinforced, flexible, low pressure hose rated up to 300 PSI should be used for routing by-pass back to the pump inlet.
- Caution should be exercised not to undersize the by-pass hose diameter and length. Refer to Technical Bulletin 064 for additional information on the size and length of the by-pass line.
- Check the pressure in the by-pass line to avoid overpressurizing the inlet.
- The by-pass line should be connected to the pump inlet line at a gentle angle of 45° or less and no closer than 10 times the pump inlet port diameter e.g. 1-1/2" port size = 15" distance from pump inlet port.

HOSE FRICTION LOSS

Water* Flow Gal/Min	PRESSURE DROP IN PSI PER 100 FT OF HOSE WITH TYPICAL WATER FLOW RATES Hose Inside Diameters, Inches						
	1/4	5/16	3/8	1/2	5/8	3/4	1"
0.5	16	5	2				
1	54	20	7	2			
2	180	60	25	6	2		
3	380	120	50	13	4	2	
4		220	90	24	7	3	
5		320	130	34	10	4	
6			220	52	16	7	1
8			300	80	25	10	2
10			450	120	38	14	3
15			900	250	80	30	7
20			1600	400	121	50	12
25				650	200	76	19
30					250	96	24
40					410	162	42
50					600	235	62
60						370	93

*At a fixed flow rate with a given size hose, the pressure drop across a given hose length will be directly proportional. A 50 ft. hose will exhibit one-half the pressure drop of a 100 ft. hose. Above values shown are valid at all pressure levels.

WATER LINE PRESSURE LOSS PRESSURE DROP IN PSI PER 100 FEET

Water GPM	Steel Pipe—Nominal Dia.						Brass Pipe—Nominal Dia.						Copper Tubing O.D. Type L					
	1/4	3/8	1/2	3/4	1	1 1/2	1/4	3/8	1/2	3/4	1	1 1/2	1/4	3/8	1/2	5/8	3/4	7/8
1	8.5	1.9					6.0	1.6					120	13	2.9	1.0		
2	30	7.0	2.1				20	5.6	1.8				400	45	10	3.4	1.3	
3	60	14	4.5	1.1			40	11	3.6				94	20	6.7	2.6		
5	150	36	12	2.8			100	28	9.0	2.2			230	50	17	6.1	3.0	
8	330	86	28	6.7	1.9		220	62	21	5.2	1.6		500	120	40	15	6.5	
10	520	130	43	10	3.0		320	90	30	7.8	2.4		180	56	22	10		
15	270	90	21	6.2	1.6		190	62	16	5.0	1.5		120	44	20			
25	670	240	56	16	4.2	2.0	470	150	40	12	3.8	1.7		330	110	50		
40		66	17	8.0				39	11	5.0				550	200	88		
60																		
80																		
100																		

RESISTANCE OF VALVES AND FITTINGS

Nominal Pipe Size Inches	Inside Diameter Inches	Equivalent Length of Standard Pipe in Feet							
		Gate Valve	Globe Valve	Angle Valve	45° Elbow	90° Elbow	180° Close Ret	Tee Thru Run	Tee Thru Branch
1/2	0.622	0.41	18.5	9.3	0.78	1.67	3.71	0.93	3.33
3/4	0.824	0.54	24.5	12.3	1.03	2.21	4.90	1.23	4.41
1	1.049	0.69	31.2	15.6	1.31	2.81	6.25	1.56	5.62
1 1/4	1.380	0.90	41.0	20.5	1.73	3.70	8.22	2.06	7.40
1 1/2	1.610	1.05	48.0	24.0	2.15	4.31	9.59	2.40	8.63
2	2.067	1.35	61.5	30.8	2.59	5.55	12.30	3.08	11.60
2 1/2	2.469	1.62	73.5	36.8	3.09	6.61	14.70	3.68	13.20
3	3.068	2.01	91.5	45.8	3.84	8.23	18.20	4.57	16.40
4	4.026	2.64	120.0	60.0	5.03	10.80	23.90	6.00	21.60

Arriving at a total line pressure loss, consideration should then be given to pressure loss created by valves, fittings and elevation of lines.

If a sufficient number of valves and fittings are incorporated in the system to materially affect the total line loss, add to the total line length, the equivalent length of line of each valve or fitting.

TYPICAL RESERVOIR TANK RECOMMENDED 6 TO 10 TIMES SYSTEM CAPACITY

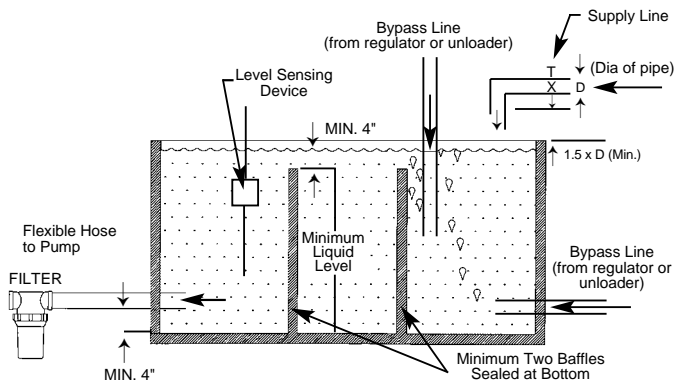

Handy Formulas to Help You

Q. How can I find the RPM needed to get specific GPM (Gallons Per Minute) I want?

A. $\text{Desired RPM} = \text{Desired GPM} \times \frac{\text{Rated RPM}}{\text{Rated GPM}}$

Q. I have to run my pump at a certain RPM. How do I figure the GPM I'll get?

A. $\text{Desired GPM} = \text{Desired RPM} \times \frac{\text{Rated GPM}}{\text{Rated RPM}}$

Q. Is there a simple way to find the approximate horsepower I'll need to run the pump?

A. $\text{Electric Brake Horsepower Required} = \frac{\text{GPM} \times \text{PSI}}{1460} \times \frac{1}{\text{Mech. Efficiency}}$ (Standard 85%)

Q. What size motor pulley should I use?

A. $\text{Pump Pulley (Outer Diameter)} \times \frac{\text{Pump RPM}}{\text{Motor/Engine RPM}}$ (Consult Engine Mfr.)

Q. How do I calculate the torque for my hydraulic drive system?

A. $\text{Torque (ft. lbs.)} = 3.6 \left(\frac{\text{GPM} \times \text{PSI}}{\text{RPM}} \right)$

Avoid Cavitation Damage

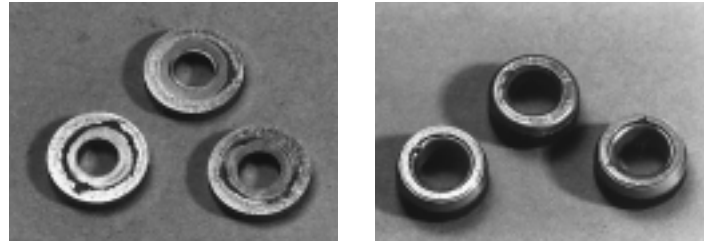

One or several of the conditions shown in the chart below may contribute to cavitation in a system resulting in premature wear, system downtime and unnecessary operating costs.

CONDITION	SOLUTION
Inadequate inlet line size	<ul style="list-style-type: none"> • Increase line size to the inlet port or one size larger
Water hammering liquid acceleration/deacceleration	<ul style="list-style-type: none"> • Install C.A.T. Tube • Move pump closer to liquid supply
Rigid Inlet Plumbing	<ul style="list-style-type: none"> • Use flexible wire reinforced hose to absorb pulsation and pressure spikes
Excessive Elbows in Inlet Plumbing	<ul style="list-style-type: none"> • Keep elbows to a minimum and less than 90°
Excessive Liquid Temperature	<ul style="list-style-type: none"> • Use Thermo Valve in bypass line • Do not exceed pump temperature specifications • Substitute closed loop with baffled holding tank • Adequately size tank for frequent or high volume bypass • Pressure feed high temperature liquids • Properly ventilate cabinets and rooms
Air Leaks in Plumbing	<ul style="list-style-type: none"> • Check all connections • Use PTFE thread tape or pipe thread sealant
Agitation in Supply Tank	<ul style="list-style-type: none"> • Size tank according to pump output — Minimum 6-10 times system GPM • Baffle tank to purge air from liquid and separate inlet from discharge
High Viscosity Liquids	<ul style="list-style-type: none"> • Verify viscosity against pump specifications before operation • Elevate liquid temperature enough to reduce viscosity • Lower RPM of pump • Pressure feed pump • Increase inlet line size
Clogged Filters	<ul style="list-style-type: none"> • Perform regular maintenance or use clean filters to monitor build up • Use adequate mesh size for liquid and pump specifications

DIAGNOSIS AND MAINTENANCE

One of the most important steps in a high pressure system is to establish a regular maintenance program. This will vary slightly with each system and is determined by various elements such as the duty cycle, the liquid being pumped, the actual specifications vs rated specifications of the pump, the ambient conditions, the inlet conditions and the accessories in the system. A careful review of the necessary inlet conditions and protection devices required before the system is installed will eliminate many potential problems.

CAT PUMPS are very easy pumps to service and require far less frequent service than most pumps. Typically, only common tools are required, making in-field service convenient, however, there are a few custom tools, special to certain models, that do simplify the process. This service manual is designed to assist you with the disassembly and reassembly of your pump. The following guide will assist in determining the cause and remedy to various operating conditions. You can also review our **FAQ** or **SERVICE** sections on our **WEB SITE** for more facts or contact CAT PUMPS directly.

PROBLEM	PROBABLE CAUSE	SOLUTION	
Low pressure	<ul style="list-style-type: none"> •Worn nozzle. •Belt slippage. •Air leak in inlet plumbing. •Pressure gauge inoperative or not registering accurately. •Relief valve stuck, partially plugged or improperly adjusted. •Inlet suction strainer (filter) clogged or improperly sized. •Abrasives in pumped liquid. •Leaky discharge hose. •Inadequate liquid supply. •Severe cavitation. •Worn seals or cups. •Worn or dirty inlet/discharge valves. 	<ul style="list-style-type: none"> •Replace with properly sized nozzle. •Tighten belt(s) or install new belt(s). •Tighten fittings and hoses. Use PTFE liquid or tape. •Check with new gauge. Replace worn or damaged gauge. •Clean/adjust relief valve. Replace worn seats/valves and o-rings. •Clean filter. Use adequate size filter. Check more frequently. •Install proper filter. •Replace discharge hose with proper rating for system. •Pressurize inlet and install C.A.T. •Check inlet conditions. •Install new seal kit or cup kit. Increase frequency of service. •Clean inlet/discharge valves or install new valve kit. 	
Pulsation	<ul style="list-style-type: none"> •Faulty Pulsation Dampener. •Foreign material trapped in inlet/discharge valves. 	<ul style="list-style-type: none"> •Check precharge. If low, recharge, or install a new dampener. •Clean inlet/discharge valves or install new valve kit. 	
Water leak	<ul style="list-style-type: none"> •Under the manifold •Into the crankcase •At the cylinders 	<ul style="list-style-type: none"> •Worn cups or Lo-Pressure Seals. •Worn sleeve o-rings. •Humid air condensing into water inside the crankcase. •Excessive wear to seals and cups. •Cut or worn o-rings. Scored sealing surface on manifold. Distorted manifold. 	<ul style="list-style-type: none"> •Install new cup or seal kit. Increase frequency of service. •Install new seal kit with o-rings. •Install oil cap protector. Change oil every 3 months or 500 hours. •Install new seal kit or cup kit. Increase frequency of service. •Install new o-rings, cylinders or discharge manifold.
Knocking noise	<ul style="list-style-type: none"> •Inlet supply •Bearing •Pulley 	<ul style="list-style-type: none"> •Inadequate inlet liquid supply. •Broken or worn bearing. •Loose pulley on crankshaft 	<ul style="list-style-type: none"> •Check liquid supply. Increase line size, pressurize and install C.A.T. •Replace bearing. •Check key and tighten set screw.
Oil leak	<ul style="list-style-type: none"> •Crankcase oil seals. •Crankshaft oil seals and o-rings. •Drain plug •Bubble gauge •Rear cover •Filler cap 	<ul style="list-style-type: none"> •Worn crankcase oil seals. •Worn crankshaft oil seals or o-rings on bearing cover. •Loose drain plug or worn drain plug o-ring. •Loose bubble gauge or worn bubble gauge gasket. •Loose rear cover or worn rear cover o-ring. •Loose filler cap or excessive oil in crankcase. 	<ul style="list-style-type: none"> •Install new crankcase oil seals. •Remove bearing cover and install new o-rings and/or oil seals. •Tighten drain plug or replace o-ring. •Tighten bubble gauge or replace gasket. •Tighten rear cover or replace o-ring. •Tighten filler cap. Fill crankcase to specified capacity.
Pump runs extremely rough	<ul style="list-style-type: none"> •Inlet conditions •Pump valves •Pump seals or cups 	<ul style="list-style-type: none"> •Restricted inlet or air entering the inlet plumbing •Stuck inlet/discharge valves. •Leaking Lo-Pressure seals or cups. 	<ul style="list-style-type: none"> •Correct inlet size plumbing. Check for air tight seal. •Clean out foreign material or install new valve kit. •Install new seal kit or cup kit. Increase frequency of service.
Premature cup or seal failure	<ul style="list-style-type: none"> •Scored cylinders or sleeves. •Front edge of piston sharp. •Over pressure to inlet manifold. •Abrasive material in the liquid being pumped. •Excessive pressure and/or temperature of pumped liquid. •Running pump dry. •Starving pump of adequate liquid. •Eroded manifold. 	<ul style="list-style-type: none"> •Replace cylinders or install new sleeve and seal kit. •Replace piston. •Reduce inlet pressure per specifications. •Install proper filtration at pump inlet and clean regularly. •Check pressure and inlet liquid temperature. •DO NOT RUN PUMP WITHOUT LIQUID. •Increase hose one size larger than inlet port size. Pressurize and install C.A.T. •Replace manifold. Check liquid compatibility. 	