

Base Mounted Turbine Pumps

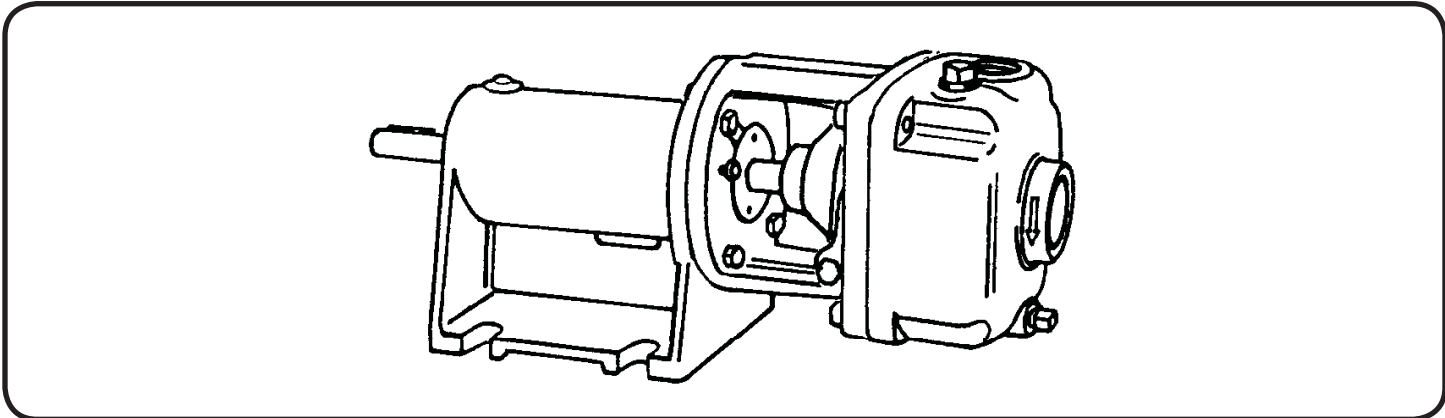

4ES - 1725 RPM - 60Hz.
ES - 3450 RPM - 60Hz.
 (See Individual curves for symbol number)

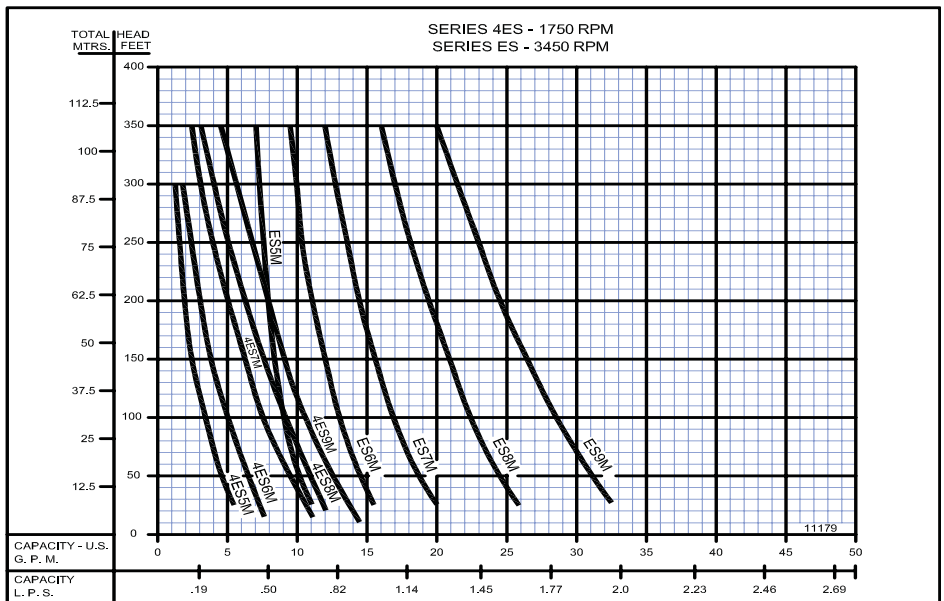

ES - 2900 RPM - 50Hz.
 (See Individual curves for symbol number)

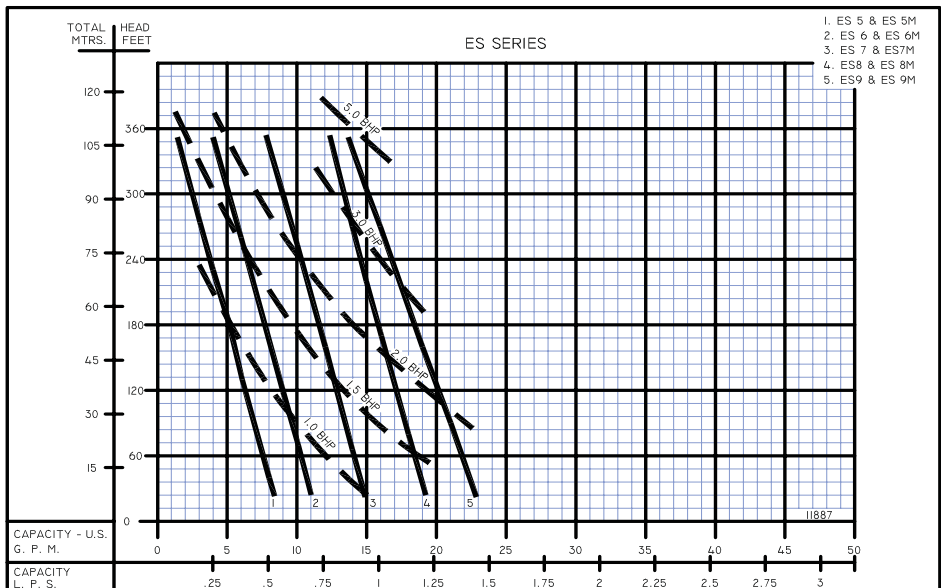

Individual performance curves should be checked for final selection.

Base Mounted Turbine Pumps

1750 RPM

60Hz - PERFORMANCE AND SELECTION CHART															
Capacity in GPM (LPS) at Total Head in Feet (m) or Pressure Shown															
Catalog Number	PSI (kpa)	8.6 (59)	17.2 (118)	26 (179)	43.3 (298)	54.1 (373)	64.9 (447)	75.8 (522)	86.6 (597)	97.4 (671)	108.3 (746)	119.1 (821)	130 (896)	140.1 (965)	151.8 (1045)
	Feet (m)	20 (6)	40 (12)	60 (18)	100 (30)	125 (38)	150 (45)	175 (53)	200 (60)	225 (68)	250 (76)	275 (83)	300 (91)	325 (99)	350 (106)
ES5M	GPM (LPS) BHP	5.6 (.35) .10	4.9 (.30) .12	4.2 (.26) .15	3.2 (.20) .22	2.8 (.17) .28	2.4 (.15) .35	2.1 (.13) .41	1.8 (.11) .48	1.6 (.10) .52	1.4 (.08) .59	1.2 (.07) .65	1.0 (.06) .69		
	Motor Size	1/4 HP			1/3 HP		1/2 HP			3/4 HP					
ES6M	GPM (LPS) BHP	7.7 (.48) .15	6.9 (.43) .20	6.2 (.39) .25	5.0 (.31) .35	4.4 (.27) .42	3.9 (.24) .48	3.6 (.22) .52	3.2 (.20) .58	2.9 (.18) .62	2.6 (.16) .65	2.4 (.15) .70	2.1 (.13) .78		
	Motor Size	1/4 HP			1/2 HP			3/4 HP			1 HP				
ES7M	GPM (LPS) BHP	10.5 (.66) .20	9.4 (.59) .28	8.6 (.54) .32	7.2 (.45) .48	6.5 (.41) .55	5.9 (.37) .64	5.4 (.34) .75	4.8 (.30) .85	4.4 (.27) .92	4.0 (.25) 1.10	3.5 (.22) 1.20	3.1 (.19) 1.35	2.7 (.17) 1.50	2.3 (.14) 1.70
	Motor Size	1/4 HP	1/3 HP		1/2 HP	3/4 HP			1 HP		1 1/4 HP		1 1/2 HP		2 HP
ES8M	GPM (LPS) BHP	12.1 (.76) .35	11.2 (.70) .42	10.3 (.64) .50	8.9 (.56) .65	8.2 (.51) .75	7.5 (.47) .85	6.8 (.42) .95	6.2 (.39) 1.10	5.6 (.35) 1.20	5.0 (.31) 1.35	4.5 (.28) 1.5	4.0 (.25) 1.6	3.6 (.22) 1.75	3.1 (.19) 1.95
	Motor Size	1/2 HP			3/4 HP		1 HP		1 1/2 HP				2 HP		
ES9M	GPM (LPS) BHP	14.5 (.91) .40	13.1 (.82) .52	12.1 (.76) .61	10.4 (.65) .80	9.6 (.60) .90	8.8 (.55) 1.05	8.2 (.51) 1.15	7.5 (.47) 1.30	6.9 (.43) 1.42	6.3 (.39) 1.60	5.7 (.35) 1.75	5.2 (.32) 1.90	4.8 (.30) 2.10	4.2 (.26) 2.35
	Motor Size	1/2 HP	3/4 HP		1 HP		1 1/2 HP				2 HP		3 HP		

3450 RPM

60Hz - PERFORMANCE AND SELECTION CHART															
Capacity in GPM (LPS) at Total Head in Feet (m) or Pressure Shown															
Catalog Number	PSI (kpa)	8.6 (59)	17.2 (118)	26 (179)	43.3 (298)	54.1 (373)	64.9 (447)	75.8 (522)	86.6 (597)	97.4 (671)	108.3 (746)	119.1 (821)	130 (896)	140.1 (965)	151.8 (1045)
	Feet (m)	20 (6)	40 (12)	60 (18)	100 (30)	125 (38)	150 (45)	175 (53)	200 (60)	225 (68)	250 (76)	275 (83)	300 (91)	325 (99)	350 (106)
ES5M	GPM (LPS) BHP	10.8 (.68) .60	10.4 (.65) .65	10.0 (.63) .70	9.2 (.58) .80	8.8 (.55) .91	8.6 (.54) .98	8.3 (.52) 1.10	8.0 (.50) 1.20	7.8 (.49) 1.30	7.6 (.47) 1.4	7.4 (.46) 1.52	7.2 (.45) 1.75	7.1 (.44) 1.85	7.0 (.44) 2.00
	Motor Size	3/4 HP			1 HP			1 1/2 HP			2 HP				
ES6M	GPM (LPS) BHP	15.6 (.98) .85	15.2 (.95) .90	14.6 (.92) 1.00	13.5 (.85) 1.20	12.9 (.81) 1.35	12.4 (.78) 1.45	11.9 (.75) 1.60	11.6 (.73) 1.70	11.2 (.70) 1.85	10.8 (.68) 1.95	10.4 (.65) 2.10	10.1 (.63) 2.20	9.8 (.61) 2.30	9.5 (.59) 2.50
	Motor Size	1 HP			1 1/2 HP			2 HP			3 HP				
ES7M	GPM (LPS) BHP	20.0 (1.26) 1.30	19.6 (1.23) 1.38	18.7 (1.17) 1.55	17.3 (1.09) 1.80	16.6 (1.04) 1.95	15.9 (1.00) 2.12	15.3 (.96) 2.28	14.8 (.93) 2.45	14.3 (.90) 2.60	13.8 (.87) 2.80	13.3 (.83) 2.95	12.8 (.80) 3.15	12.5 (.78) 3.25	12.1 (.75) 3.5
	Motor Size	1 1/2 HP		2 HP			3 HP			5 HP					
ES8M	GPM (LPS) BHP	26.2 (1.65) 1.60	25.6 (1.61) 1.70	24.5 (1.54) 1.80	22.9 (1.44) 2.20	22.0 (1.38) 2.40	21.2 (1.33) 2.60	20.5 (1.29) 2.80	19.8 (1.24) 3.00	19.2 (1.21) 3.30	18.5 (1.16) 3.60	18.0 (1.13) 3.80	17.4 (1.09) 4.10	16.9 (1.06) 4.40	16.4 (1.03) 4.90
	Motor Size	2 HP			3 HP			5 HP							
ES9M	GPM (LPS) BHP	32.0 (2.01) 2.00	31.5 (1.98) 2.10	30.5 (1.92) 2.30	28.6 (1.61) 2.70	27.5 (1.73) 3.00	26.5 (1.67) 3.20	25.6 (1.61) 3.50	24.7 (1.55) 3.70	23.9 (1.50) 3.90	23.0 (1.45) 4.20	22.2 (1.40) 4.40	21.5 (1.35) 4.60	20.7 (1.30) 4.90	20.0 (1.26) 5.10
	Motor Size	2 HP	3 HP			5 HP						7 1/2 HP			

NOTE: When pumping hot water over 180°F (82.2°C), check the NPSH available in the pumping system against the required pump NPSH shown on pump performance curves. Available NPSH must be greater than required NPSH.

Base Mounted Turbine Pumps

50Hz - PERFORMANCE AND SELECTION CHART															
Capacity in GPM (LPS) at Total Head in Feet (m) or Pressure Shown															
Catalog Number	PSI (kpa)	13 (89)	17.2 (118)	26 (179)	43.3 (298)	54.1 (373)	64.9 (447)	75.8 (522)	86.6 (597)	97.4 (671)	108.3 (746)	119.1 (821)	130 (896)	140.1 (965)	151.8 (1045)
	Feet (m)	30 (9)	40 (12)	60 (18)	100 (30)	125 (38)	150 (45)	175 (53)	200 (60)	225 (68)	250 (76)	275 (83)	300 (91)	325 (99)	350 (106)
ES5M	GPM (LPS) BHP	8.2 (.51) .990	8.0 (.50) .991	7.5 (.47) .994	6.6 (.41) .996	6.0 (.37) .998	5.6 (.35) 1.00	5.2 (.32) 1.05	4.8 (.30) 1.11	4.0 (.25) 1.23	3.5 (.22) 1.33	3.0 (.18) 1.43	2.5 (.15) 1.51		
	Motor Size	1 HP						1½ HP							
ES6M	GPM (LPS) BHP	11.0 (.69) .990	10.5 (.66) .993	10.3 (.64) .996	9.2 (.58) 1.06	9.0 (.56) 1.09	8.3 (.52) 1.14	7.8 (.49) 1.15	7.3 (.46) 1.24	6.8 (.42) 1.34	6.2 (.39) 1.49	5.5 (.34) 1.68	5.0 (.31) 1.77	4.5 (.28) 1.87	4.0 (.25) 1.98
	Motor Size	1 HP			1½ HP					2 HP					
ES7M	GPM (LPS) BHP	15.0 (.94) .94	14.5 (.91) 1.05	14.0 (.88) 1.13	13.2 (.83) 1.33	12.8 (.80) 1.42	12.2 (.76) 1.55	11.7 (.73) 1.63	11.2 (.70) 1.75	10.5 (.66) 1.89	10.0 (.63) 2.0	9.5 (.59) 2.28	9.0 (.56) 2.5	8.3 (.52) 2.83	8.0 (.50) 2.94
	Motor Size	1 HP	1½ HP			2 HP				3 HP					
ES8M	GPM (LPS) BHP	19.2 (1.21) 1.27	19.0 (1.19) 1.38	18.4 (1.16) 1.55	17.5 (1.10) 1.80	17.0 (1.07) 1.90	16.5 (1.04) 2.02	16.0 (1.00) 2.07	15.3 (.96) 2.21	15.0 (.94) 2.27	14.5 (.91) 2.52	14.0 (.88) 2.74	13.3 (.83) 3.19	13.0 (.82) 3.39	12.2 (.76) 3.95
	Motor Size	1½ HP		2 HP			3 HP					5 HP			
ES9M	GPM (LPS) BHP	22.5 (1.41) 1.5	22.3 (1.40) 1.55	22.0 (1.38) 1.63	20.5 (1.29) 2.09	20.0 (1.26) 2.18	19.3 (1.21) 2.35	18.5 (1.16) 2.50	18.0 (1.13) 2.61	17.3 (1.09) 2.65	17.8 (1.12) 2.83	16.0 (1.00) 3.41	15.0 (.94) 3.98	14.5 (.91) 4.17	13.7 (.86) 4.42
	Motor Size	1½ HP	2 HP		3 HP					5 HP					



NOTE: When pumping hot water over 180°F (82.2°C), check the NPSH available in the pumping system against the required pump NPSH shown on pump performance curves. Available NPSH must be greater than required NPSH.

Base Mounted Turbine Pumps

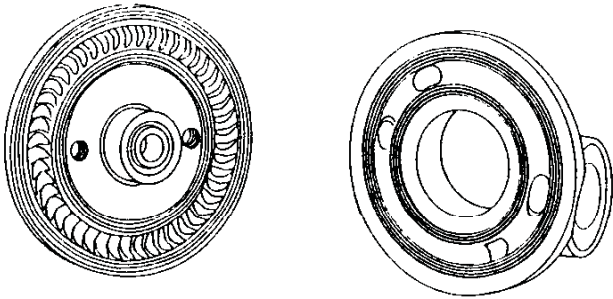

BURKS exclusive, unique regenerative type turbine pumps are designed to handle clear water and many other non-abrasive, lower viscosity liquids on high pressure, low capacity applications with the greatest possible efficiency. BURKS is the only turbine pump with Life-Lok[®] External Impeller Adjustment feature that allows readjustment of impeller without disturbing piping, disassembling pump or replacing parts. Gives up to 40% longer service life than turbine pumps of other designs. Coupling guard furnished on all complete Base-Mounted units manufactured by Burks Pumps. Not furnished with purchase of pump only, but required.

QUALITY FEATURES:

- Self-Priming
- Compact, space-saving size
- Dependable carbon/ceramic mechanical shaft seal for temperatures to 225°F (107°C).
- Bronze impeller with Monel blades - the only moving part
- Bronze raceway with cast-in vortex pockets - will not vapor lock
- #303 Stainless Steel pump shaft
- Easy to service
- Every pump factory tested
- Available Bronze fitted, all Bronze, Stainless Steel

MAXIMUM OPERATING CONDITIONS	
TEMPERATURE (For Standard Buna-N Seal)	225°F (107°C)
INLET PRESSURE	100 PSI (689kPa)
CASING WORKING PRESSURE	250 PSI (1723kPa)

FOR TEMPERATURES TO 500°F (260°C)

Series ES Pumps are available in a Jacketed Seal Cavity design for pumping hot oil, hot water and heat transfer fluids in common use in high temperature heating or cooling applications. This feature greatly extends seal life in high temperature applications. To order, add suffix "J" to pump catalog number for temperatures below 400°F (204°C) and add suffix "JK" to pump catalog number for temperatures over 400°F (204°C). *Example: ES6MJ.* See Section on High Temperature Pumps for more information.

MATERIALS OF CONSTRUCTION			
PART	BRONZE FITTED	ALL BRONZE	STAINLESS STEEL
Bearing Housing	Cast Iron	Cast Iron	Cast Iron
Adapter	Cast Iron	Bronze	#316 Stainless
Case	Cast Iron	Bronze	#316 Stainless
Raceway	Bronze	Bronze	#303 Stainless
Impeller	Bronze (Monel Blades)	Bronze (Monel Blades)	#303 Stainless
Shaft	#303 Stainless	#303 Stainless	#303 Stainless
Shaft Seal	Carbon-Ceramic SS - Buna-N	Carbon-Ceramic SS - Buna-N	Carbon-Ceramic SS - Buna-N

Base Mounted Turbine Pumps

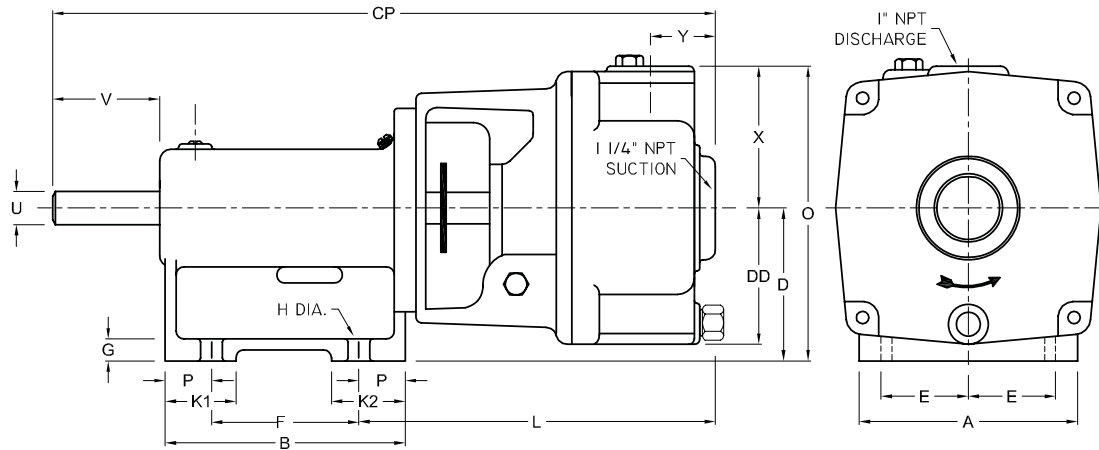

DIMENSIONS IN INCHES (mm)																					
A	B	CP	CP (S.S.)	D	DD	E	F	G	H	K1	K2	L	L (S.S.)	O	P	S	U	V	X	Y	Y (S.S.)
5 (126)	5½ (139)	15½ (384)	16⅛ (424)	3½ (88)	3⅝ (79)	2 (50)	3¾ (85)	½ (13)	½ (13)	1⅝ (41)	1⅞ (42)	8¾ (212)	8⅜ (224)	6¾ (171)	1⅞ (27)	1⅜ (30)	¾ (19)	2¼ (57)	¾ (82)	1⅞ (42)	1⅞ (42)

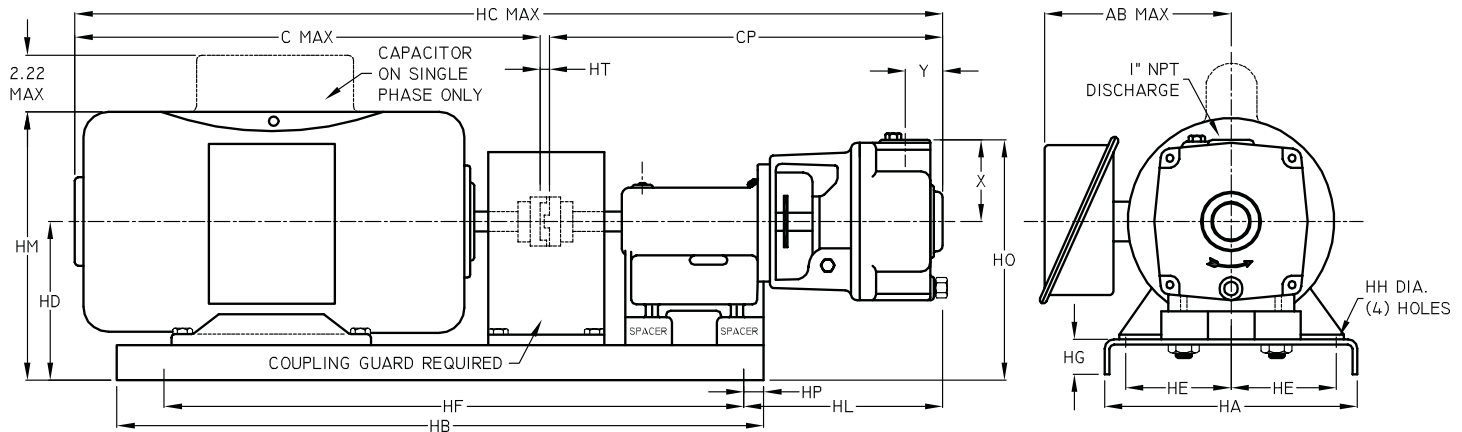

DIMENSIONS IN INCHES (mm)																						
Motor Frame	AB	C	CP	CP (S.S.)	HA	HB	HC	HC (S.S.)	HD	HE	HF	HG	HH	HL	HL (S.S.)	HM	HO	HP	HT	X	Y	Y (S.S.)
56	---	12½ (318)	15⅝ (384)	16⅛ (424)	8 (203)	22 (558)	28⅝ (715)	28⅝ (727)	6 (152)	3 (76)	20 (508)	2½ (63)	1⅞ (17)	8⅞ (211)	8⅜ (224)	9⅞ (233)	9¼ (234)	1 (25)	9/16 (14)	¾ (82)	1⅞ (42)	1⅞ (42)
143T	6⅞ (157)	10⅞ (271)	15⅝ (384)	16⅛ (424)	8 (203)	22 (558)	26⅝ (669)	26⅞ (681)	6 (152)	3 (76)	20 (508)	2½ (63)	1⅞ (17)	8⅞ (211)	8⅜ (224)	9⅞ (241)	9¼ (234)	1 (25)	9/16 (14)	¾ (82)	1⅞ (42)	1⅞ (42)
145T	6⅞ (157)	11⅞ (271)	15⅝ (384)	16⅛ (424)	8 (203)	22 (558)	27⅝ (695)	27⅞ (706)	6 (152)	3 (76)	20 (508)	2½ (63)	1⅞ (17)	8⅞ (211)	8⅜ (224)	9⅞ (241)	9¼ (234)	1 (25)	9/16 (14)	¾ (82)	1⅞ (42)	1⅞ (42)
182T	8¼ (209)	12¾ (323)	15⅝ (384)	16⅛ (424)	10 (254)	25 (635)	28⅞ (728)	29⅞ (740)	7 (177)	4 (101)	23 (584)	2½ (63)	1⅞ (17)	8⅞ (211)	8⅜ (224)	11½ (292)	10¼ (260)	1 (25)	13/16 (20)	¾ (82)	1⅞ (42)	1⅞ (42)
184T	8¼ (209)	13¼ (349)	15⅝ (384)	16⅛ (424)	10 (254)	25 (635)	29⅞ (754)	30⅞ (765)	7 (177)	4 (101)	23 (584)	2½ (63)	1⅞ (17)	8⅞ (211)	8⅜ (224)	11½ (292)	10¼ (260)	1 (25)	13/16 (20)	¾ (82)	1⅞ (42)	1⅞ (42)
213T	8¼ (209)	15¼ (400)	15⅝ (384)	16⅛ (424)	11 (279)	28¾ (730)	31⅞ (804)	32⅞ (790)	7¾ (196)	4½ (114)	26¼ (679)	2½ (63)	1⅞ (17)	8⅞ (211)	8⅜ (224)	13⅞ (331)	11 (279)	1 (25)	13/16 (20)	¾ (82)	1⅞ (42)	1⅞ (42)
215T	8¼ (209)	17¼ (438)	15⅝ (384)	16⅛ (424)	11 (279)	28¾ (730)	33⅞ (842)	33⅞ (854)	7¾ (196)	4½ (114)	26¼ (679)	2½ (63)	1⅞ (17)	8⅞ (211)	8⅜ (224)	13⅞ (331)	11 (279)	1 (25)	13/16 (20)	¾ (82)	1⅞ (42)	1⅞ (42)

A strainer, approximately 20 mesh, should be installed on the suction side of the pump to prevent chips, scale or hard foreign particales from entering the pump and damaging the raceway and impeller.

Base Mounted Turbine Pumps

1725 RPM

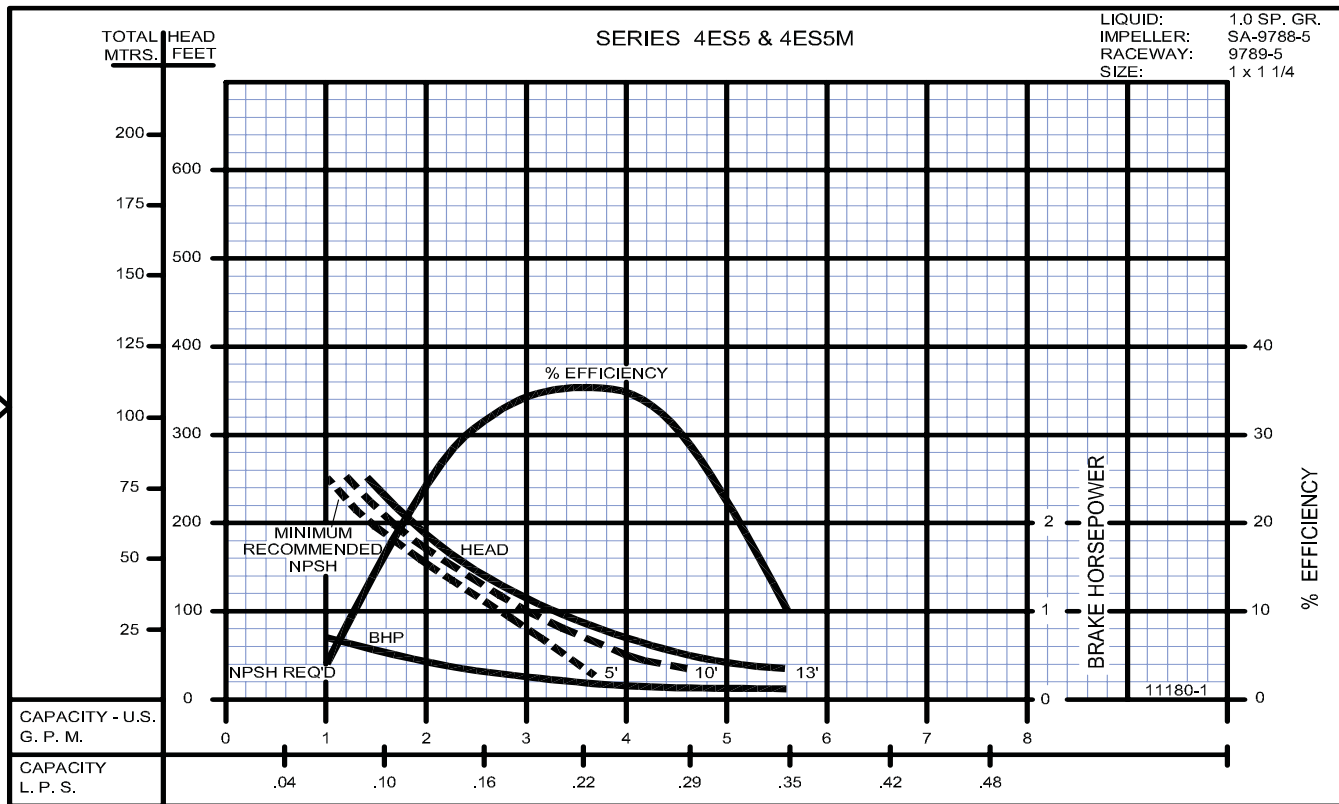

3450 RPM

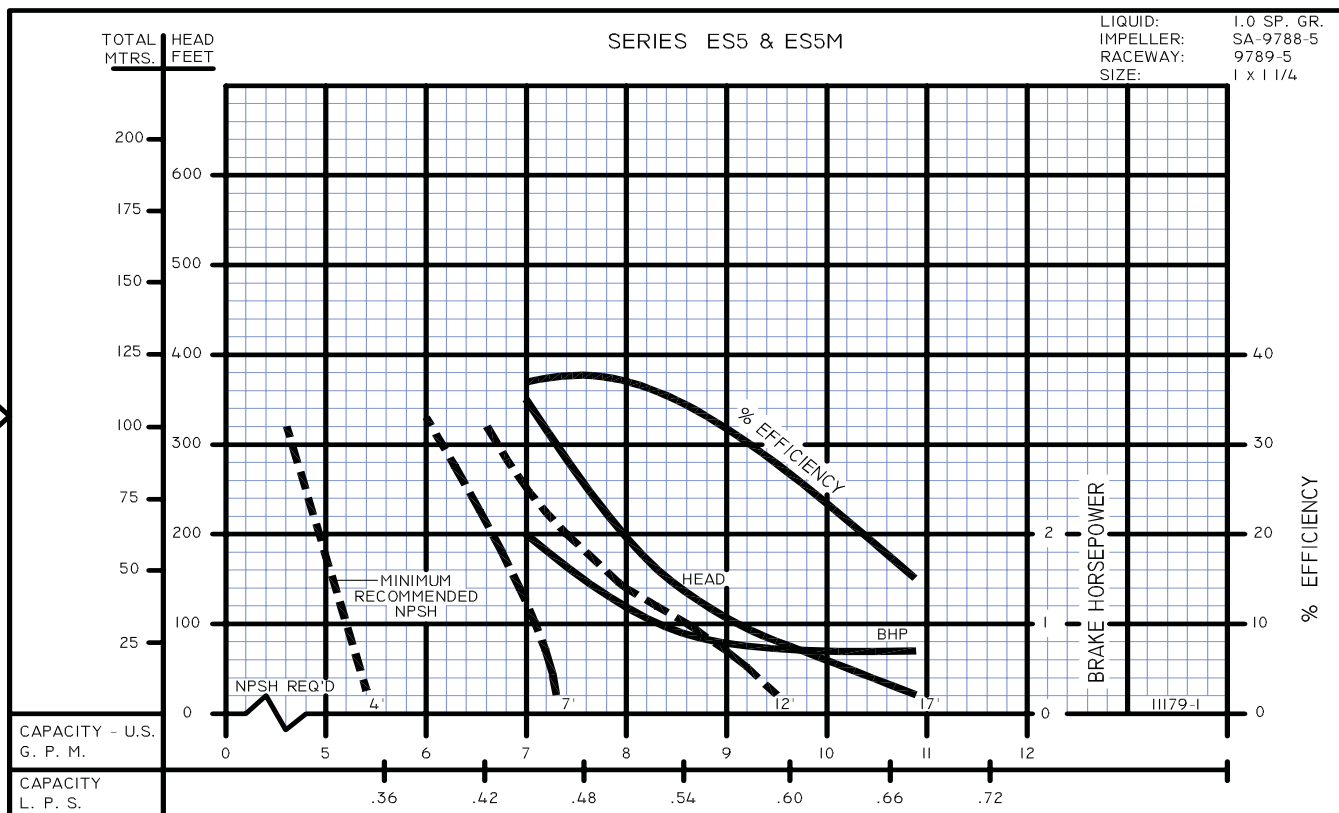

SECTION 6B
PAGE 6
DATE 1/06

CRANE[®]

PUMPS & SYSTEMS

A Crane Co. Company

USA: (937) 778-8947 • Canada: (905) 457-6223 • International: (937) 615-3598

Base Mounted Turbine Pumps

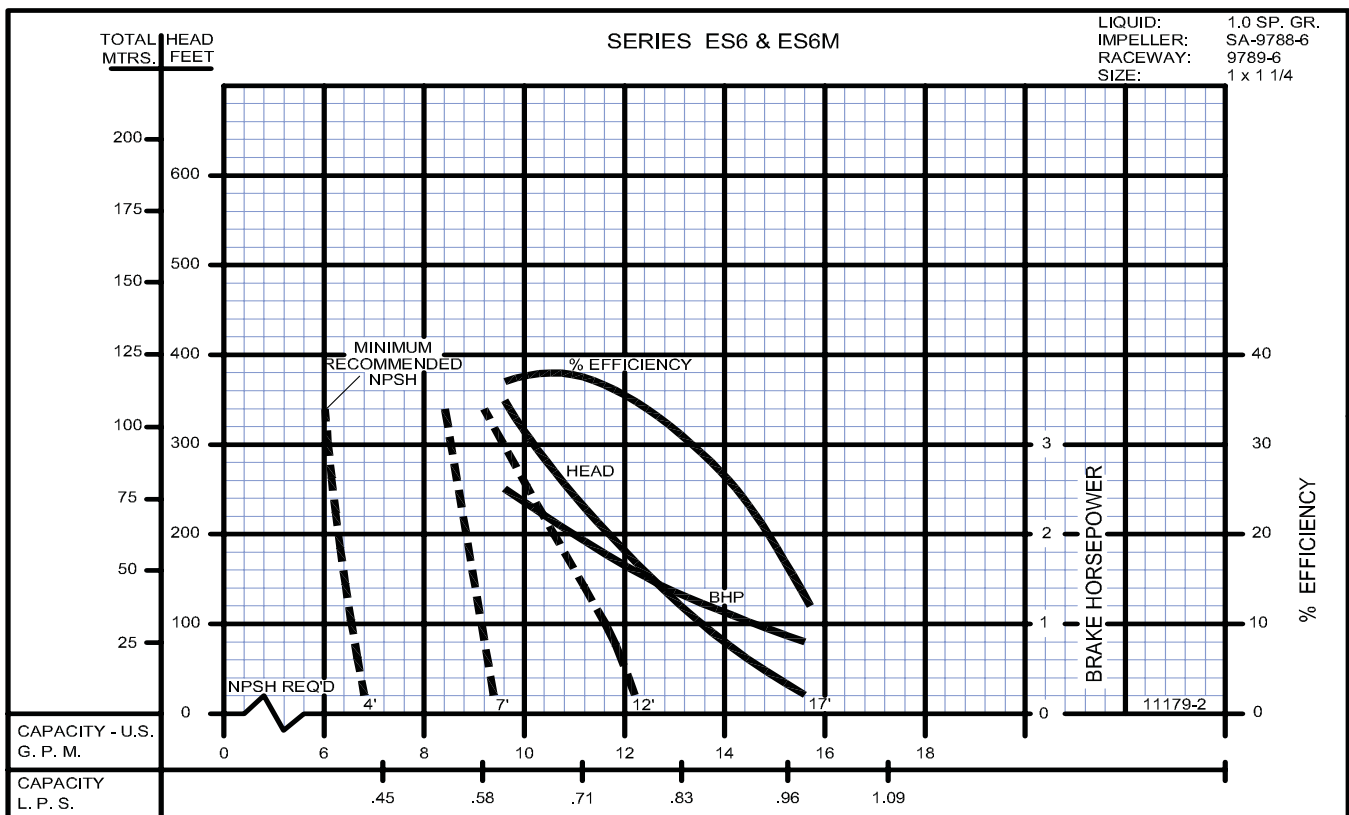
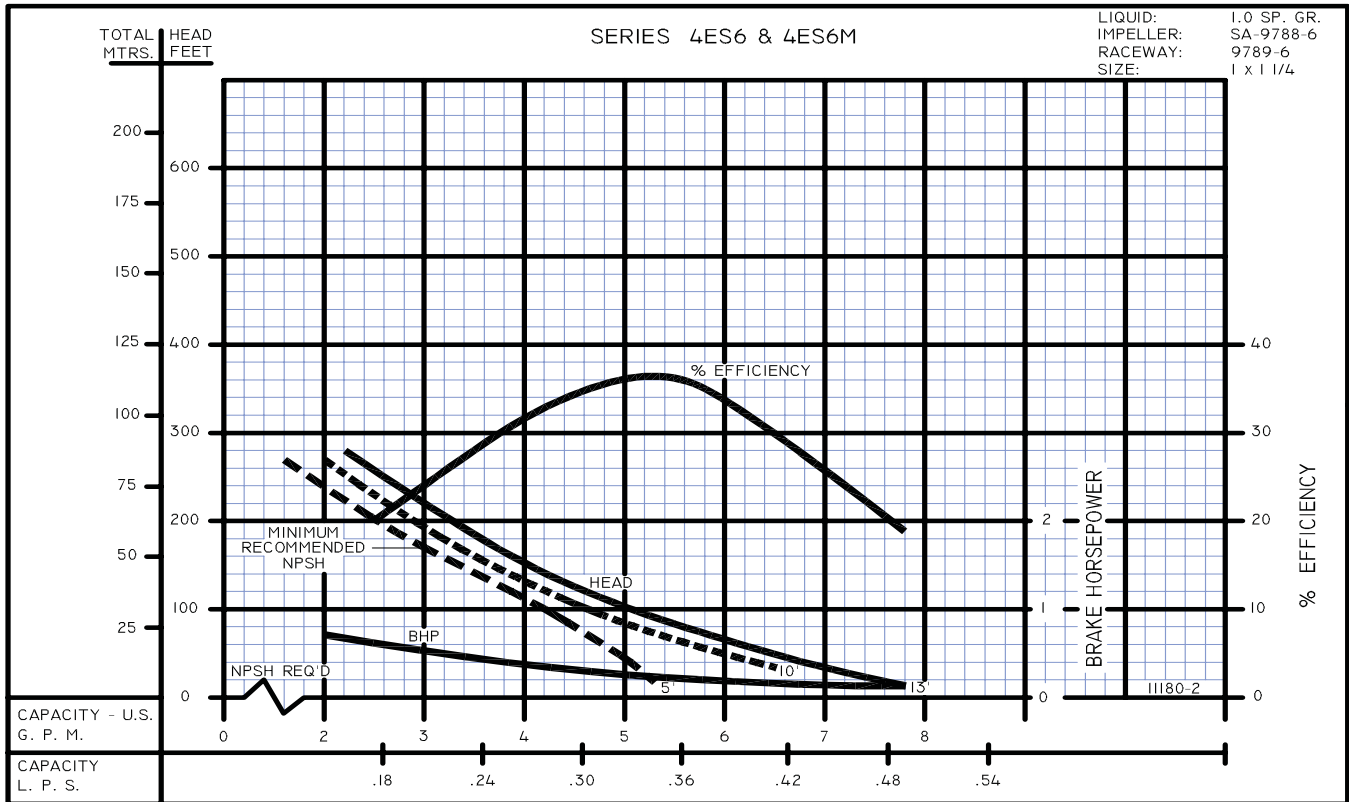

Base Mounted Turbine Pumps

1725
RPM

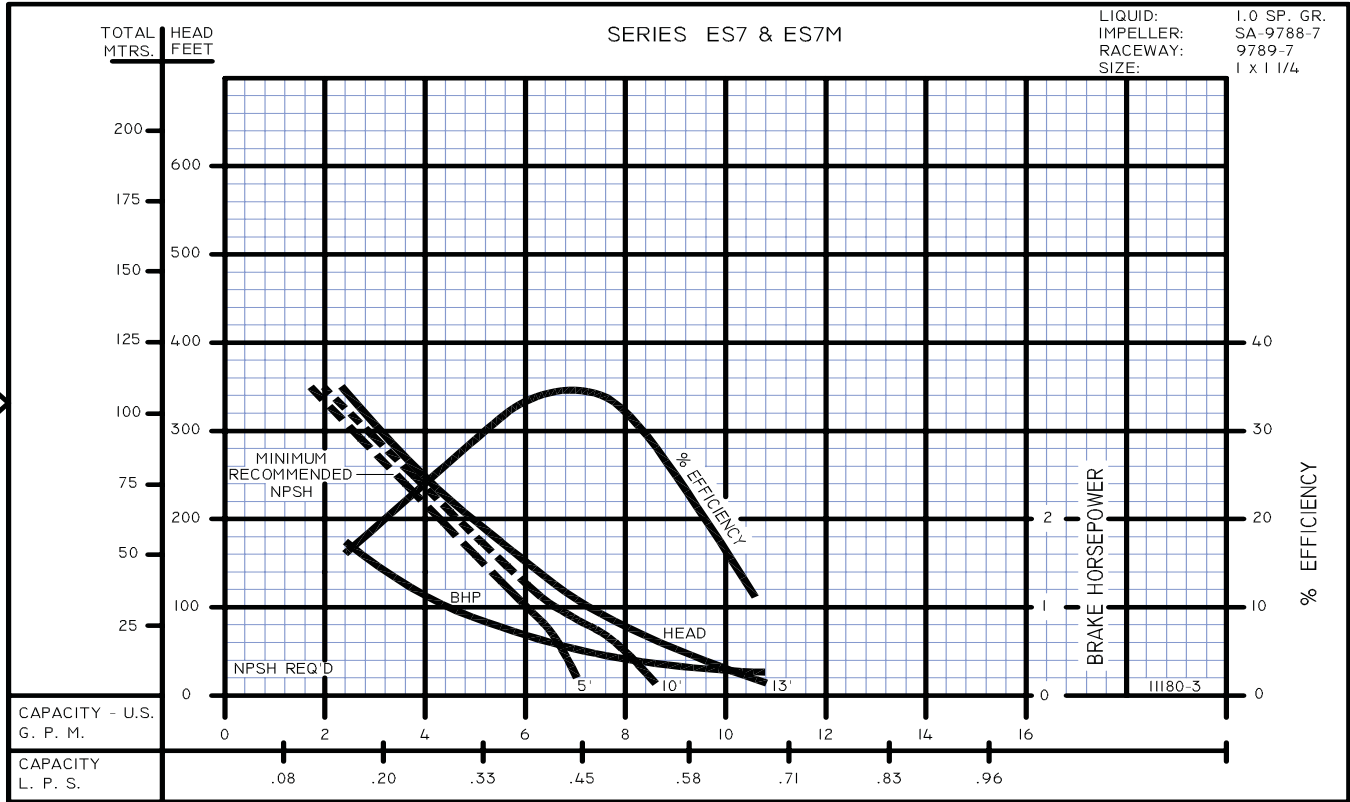

3450
RPM

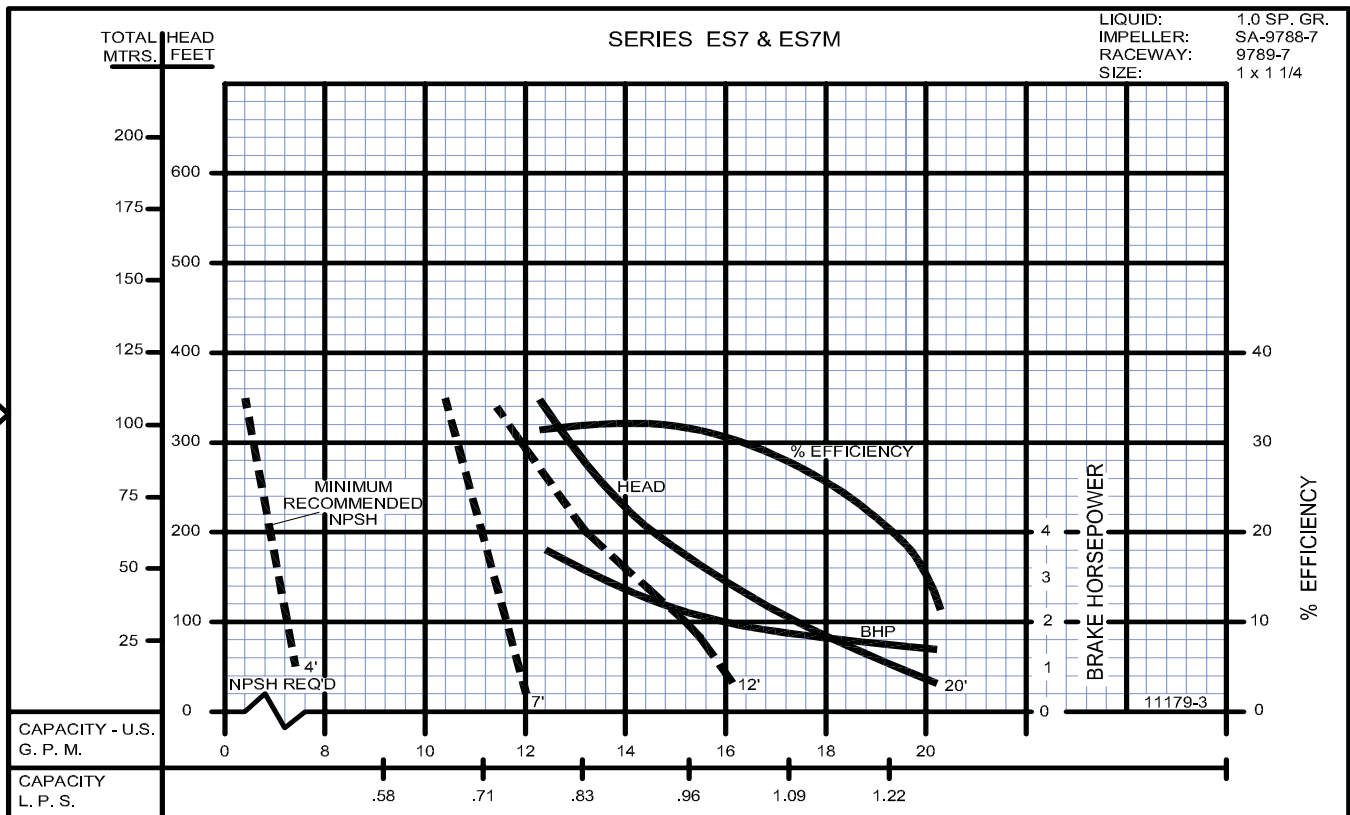

SECTION 6B
PAGE 8
DATE 1/06

CRANE[®]

PUMPS & SYSTEMS

A Crane Co. Company

USA: (937) 778-8947 • Canada: (905) 457-6223 • International: (937) 615-3598

Base Mounted Turbine Pumps

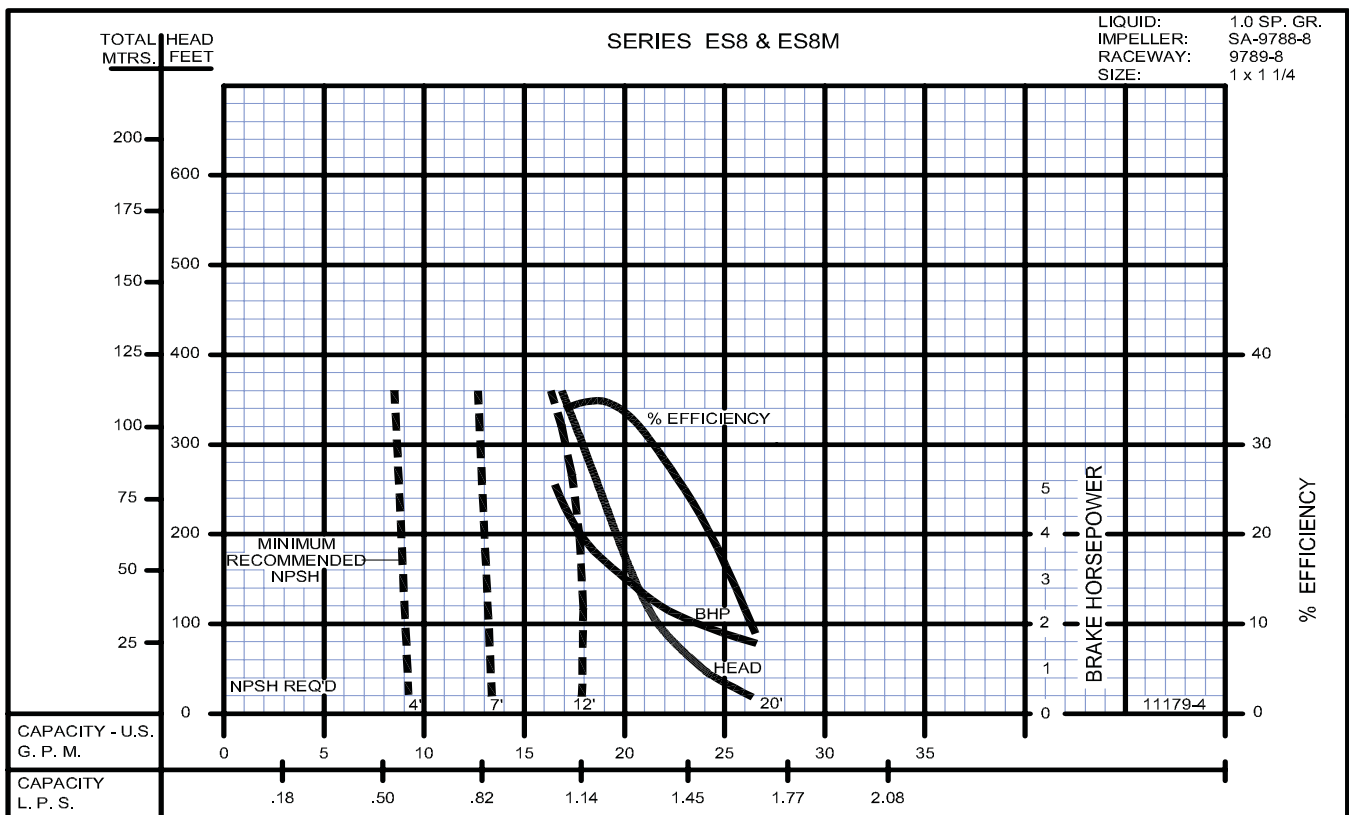
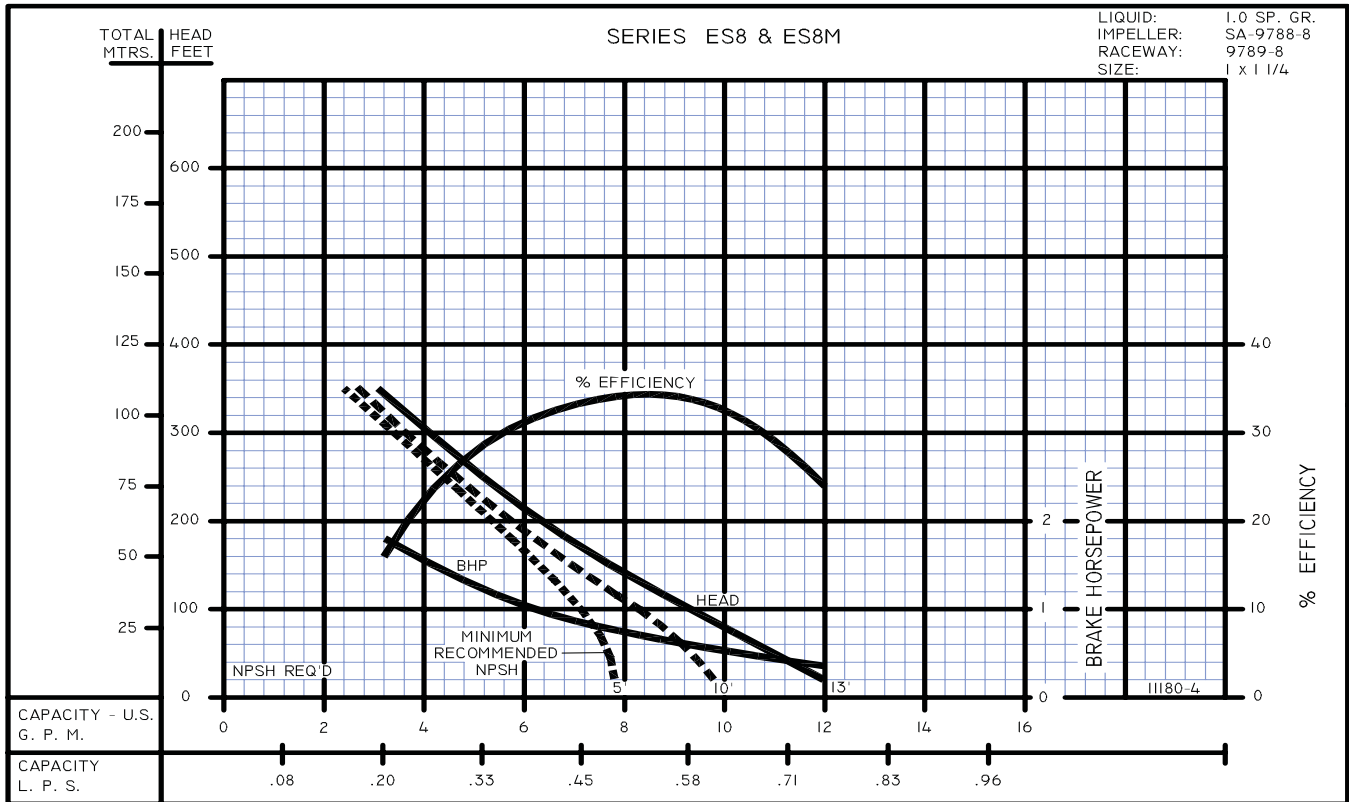

Base Mounted Turbine Pumps

1725 RPM

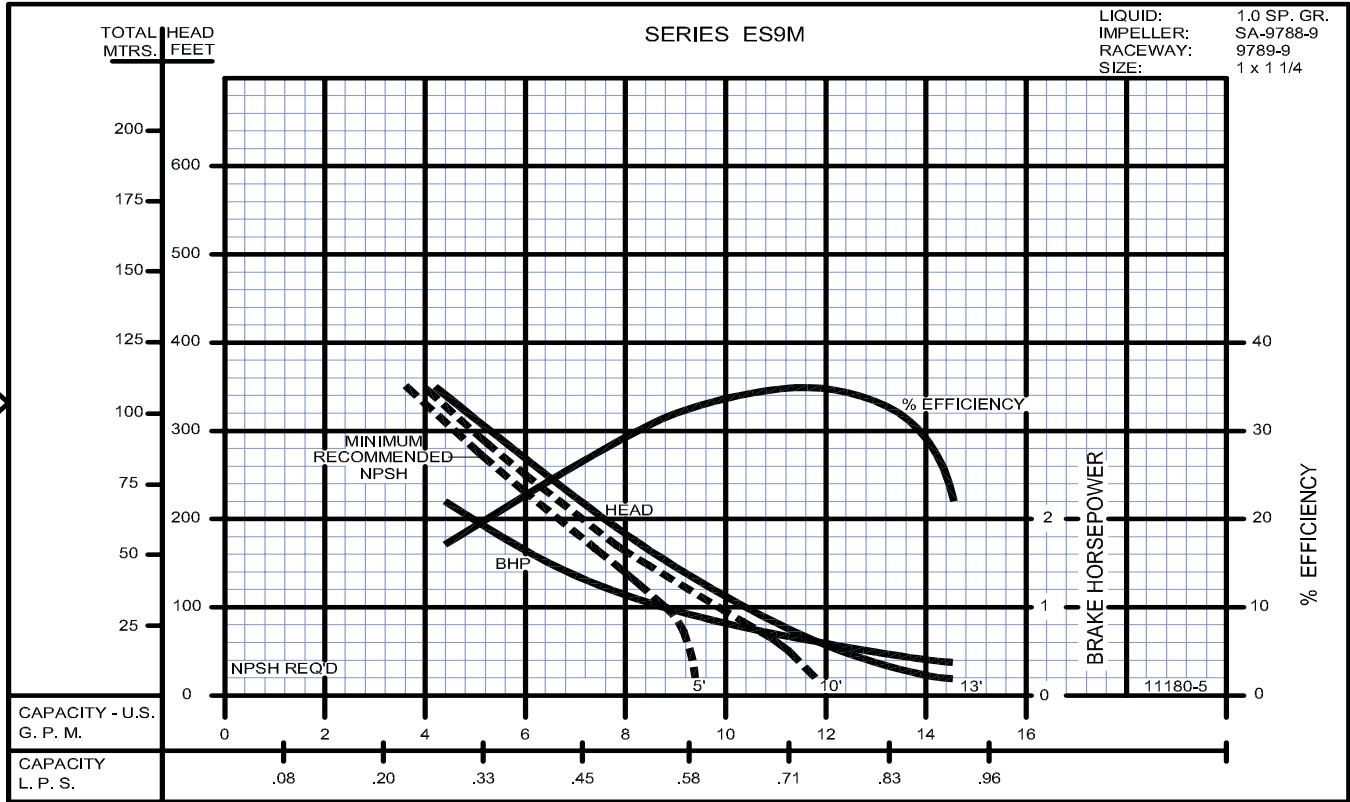

3450 RPM

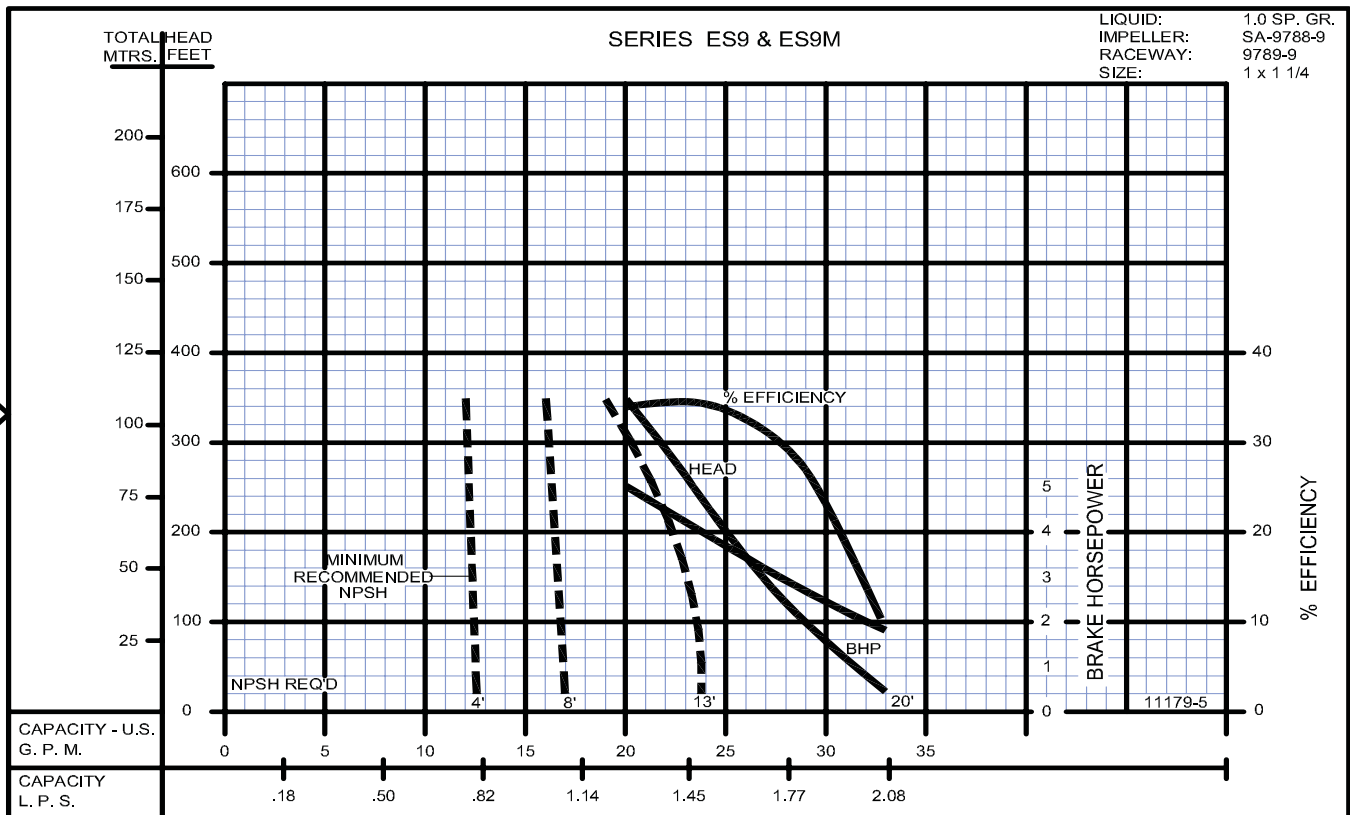

SECTION 6B
PAGE 10
DATE 1/06



PUMPS & SYSTEMS

A Crane Co. Company

USA: (937) 778-8947 • Canada: (905) 457-6223 • International: (937) 615-3598

Base Mounted Turbine Pumps

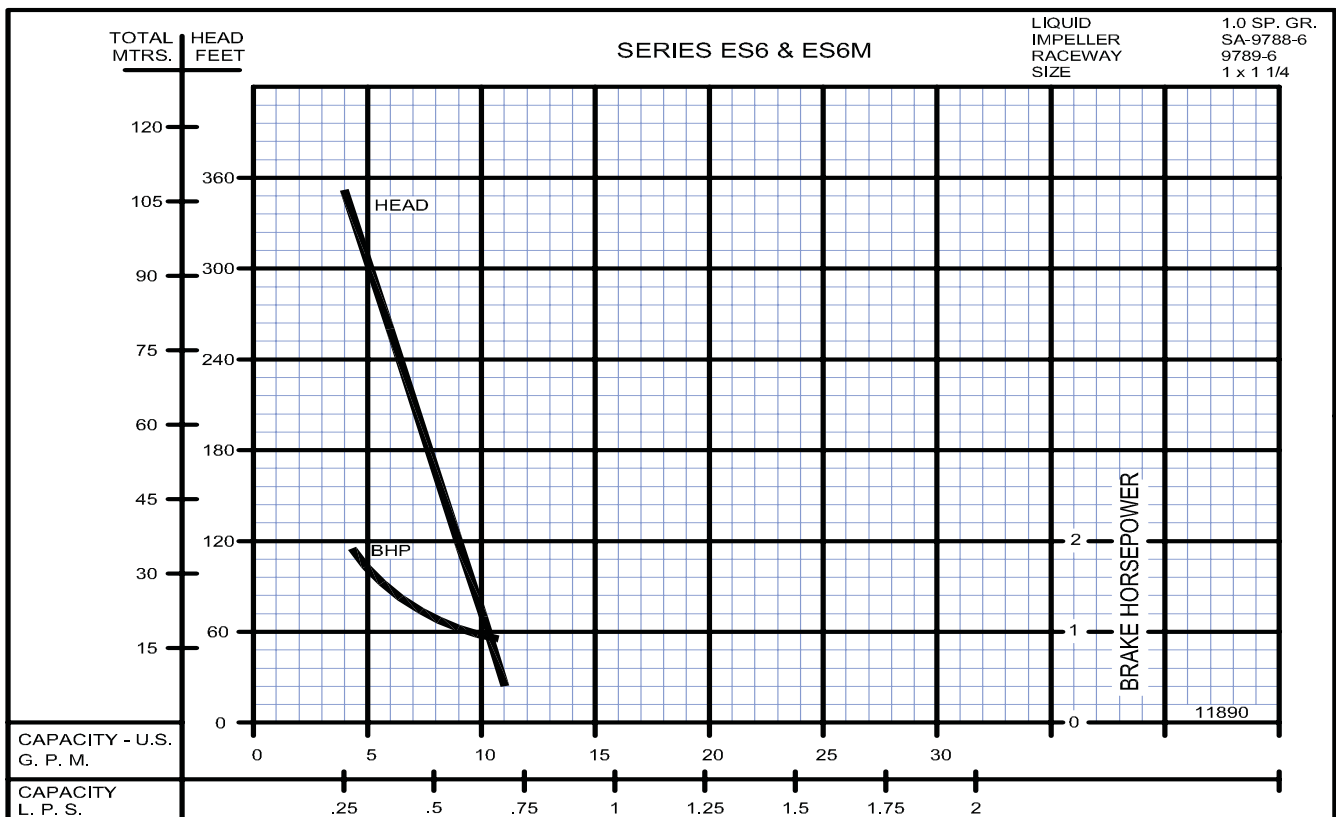
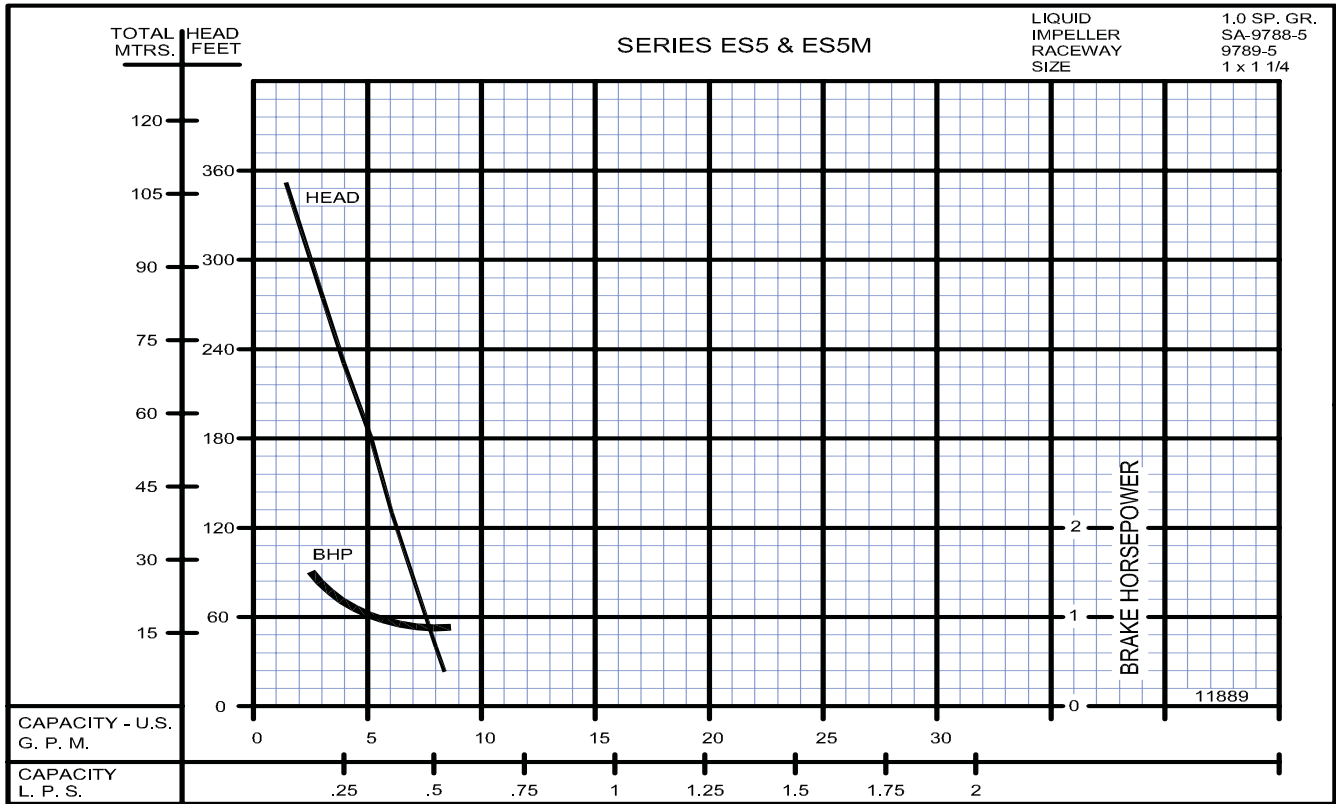

Base Mounted Turbine Pumps

2900
RPM

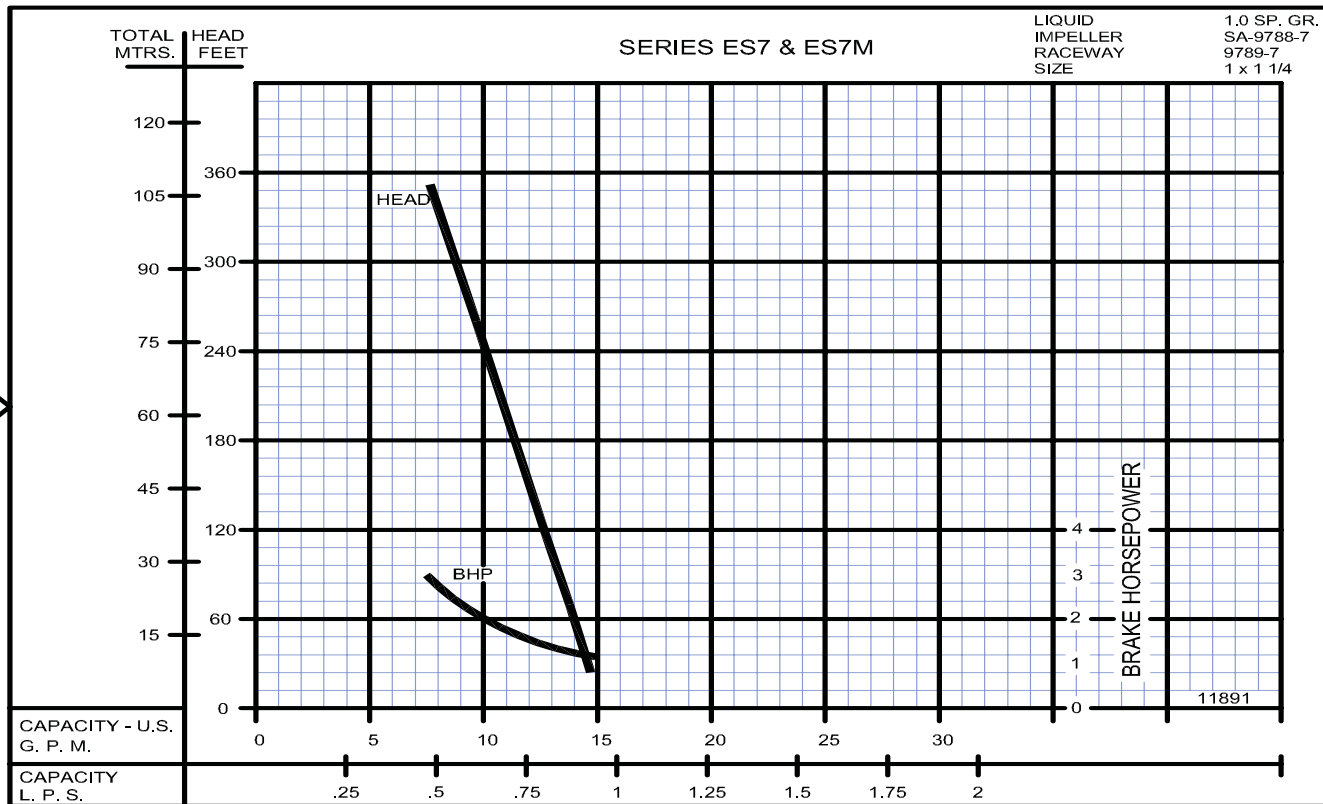

2900
RPM

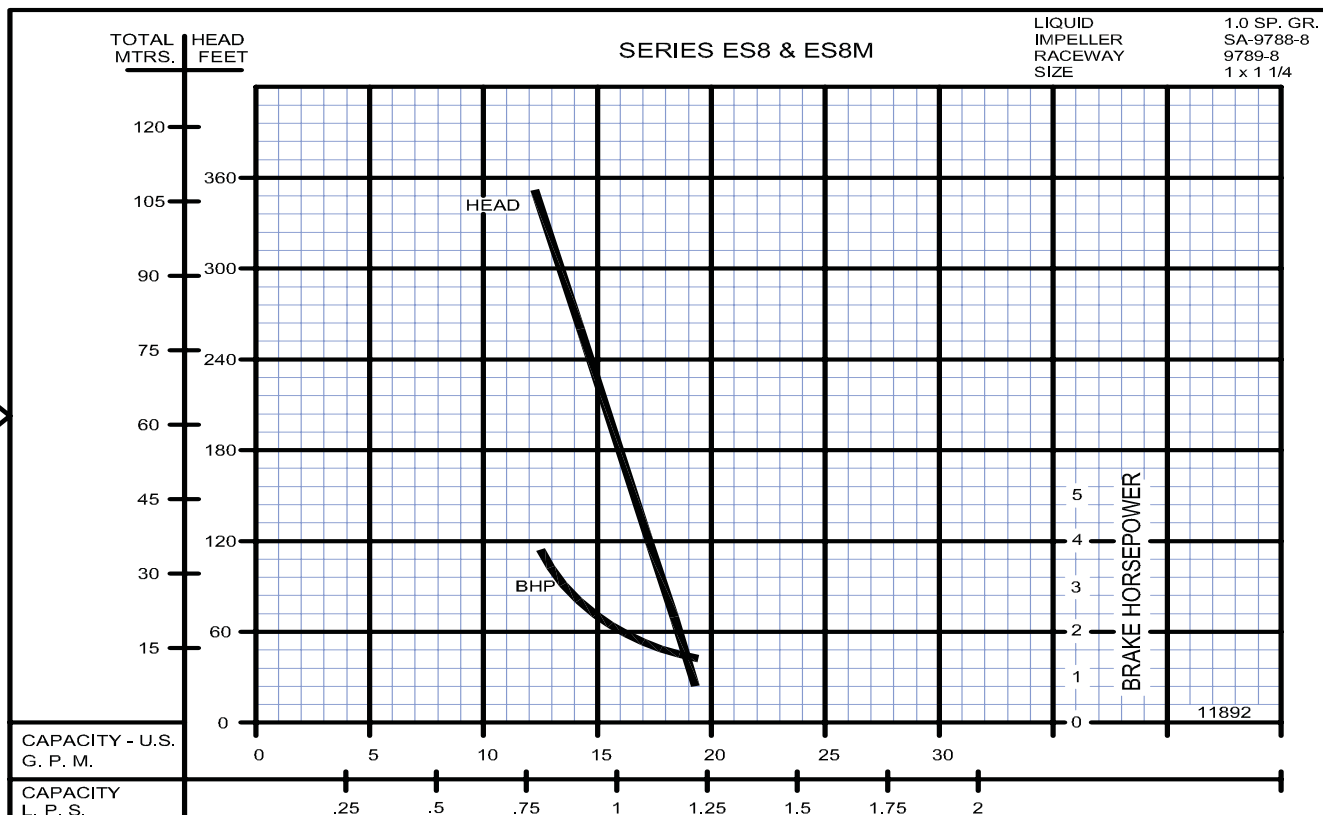

SECTION 6B
PAGE 12
DATE 1/06



A Crane Co. Company

PUMPS & SYSTEMS

USA: (937) 778-8947 • Canada: (905) 457-6223 • International: (937) 615-3598

Base Mounted Turbine Pumps

