

Close Coupled Turbine Pumps

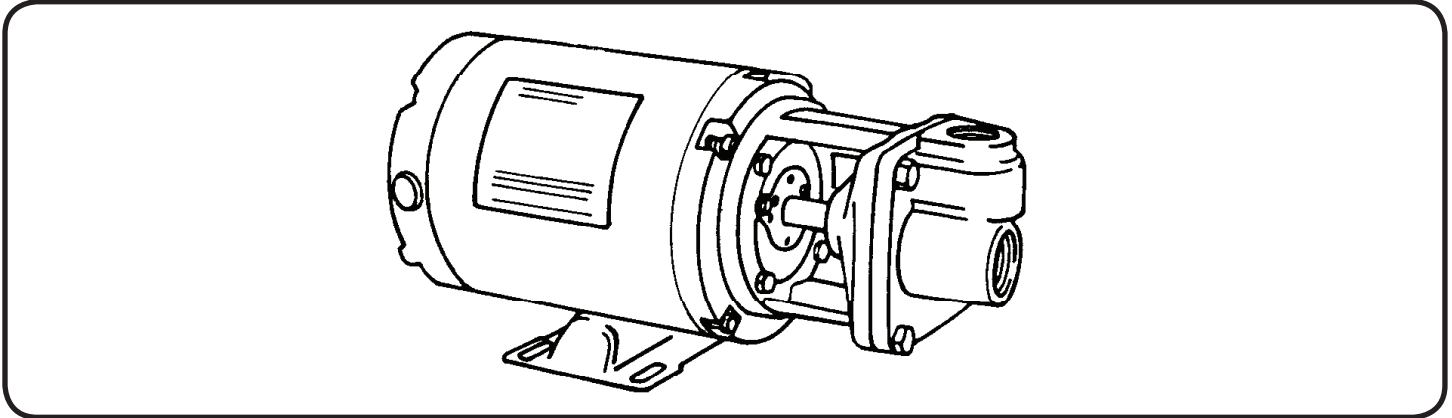

4CT - 1725 RPM - 60Hz.

CT - 3450 RPM - 60Hz.

(See Individual curves for symbol number)

| *MAXIMUM HEAD | | | |
|---------------|-----|----------------|-----------|
| Symbol Number | HP | Catalog Number | |
| | | 1 - Phase | 3 - Phase |
| 1 | 1/2 | 5CT7M | 35CT7M |
| 2 | 3/4 | 7CT7M | 37CT7M |
| 3 | 1/3 | 3CT6M | 33CT6M |
| 4 | 1/2 | 5CT6M | 35CT6M |
| 5 | 3/4 | 7CT6M | 37CT6M |
| 6 | 1/3 | 3CT5M | 33CT5M |
| 7 | 1/2 | 5CT5M | 35CT5M |
| 8 | 1/4 | 24CT7M | |
| 9 | 1/4 | 24CT6M | |
| 10 | 1/2 | 5CT8M | 35CT8M |
| 11 | 3/4 | 7CT8M | 37CT8M |

(*) For Standard Pumps with ODP motors

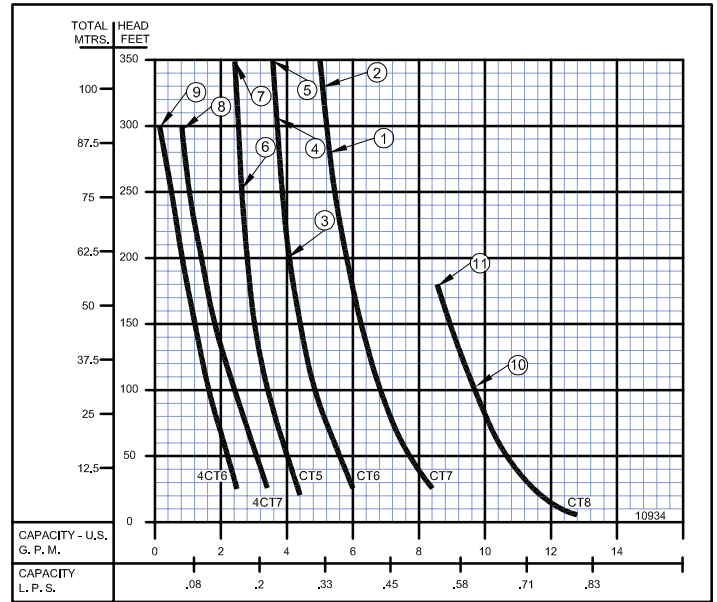

CT - 2900 RPM - 50Hz.

(See Individual curves for symbol number)

| MAXIMUM HEAD | | | | |
|---------------|-------|----------------|-------|-----------|
| Symbol Number | HP | Catalog Number | Phase | Enclosure |
| 1 | .8 | L35CT7M | 3 | ODP |
| **2 | 1.0 | TL310CT7M | 3 | TEFC |
| 3 | 1.125 | L37CT7M | 3 | ODP |
| 5 | .58 | L33CT6M | 3 | ODP |
| 6 | .8 | L35CT6M | 3 | ODP |
| **7 | 1.0 | TL310CT6M | 3 | TEFC |
| 8 | 1.125 | L37CT6M | 3 | ODP |
| 9 | .58 | L33CT5M | 3 | ODP |
| 10 | .8 | L35CT5M | 3 | ODP |

(*) This pump is 115/230 Volt Single Phase Only.

(**) This pump is available only with TEFC motor for 50 Hz use.

All of the pumps above are available with stuffing box.

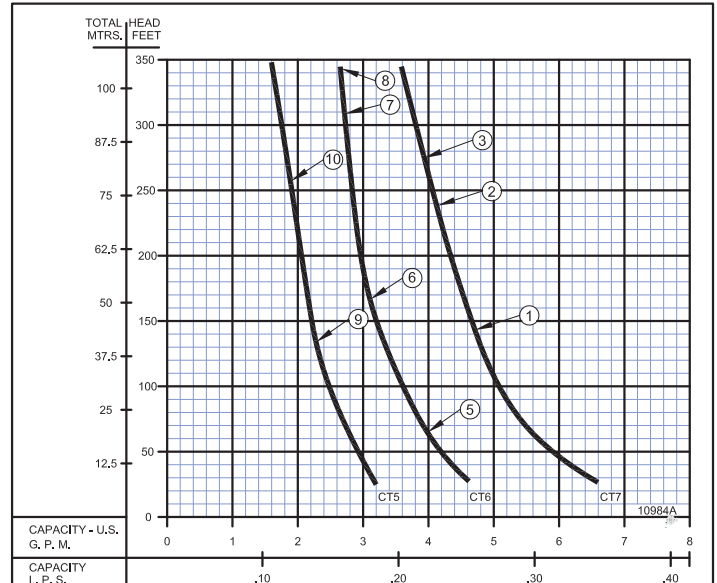

Close Coupled Turbine Pumps

| 60 HZ - PERFORMANCE & SELECTION CHART | | | | | | | | | | | | | | | | | | | |
|---------------------------------------|---------|-----------------|-----------|-----------|----------|------------|------------|----------|-------------|-------------|-------------|-------------|-------------|-------------|--------------|--------------|------------|--------------|--------------|
| Catalog Number | | HP | Tappings | | PSI Feet | TOTAL HEAD | | | | | | | | | | | | | |
| | | | Suct. NPT | Disc. NPT | | 8.6 20 | 17.2 40 | 26 60 | 43.3 100 | 54.1 125 | 64.9 150 | 75.8 175 | 86.6 200 | 97.4 225 | 108.3 250 | 119.1 275 | 130 300 | 140.1 325 | 151.6 350 |
| 1 Phase | 3 Phase | CAPACITY IN GPM | | | | | | | | | | | | | | | | | |
| 1750 RPM | 24CT6M | ---- | 1/4 | 1 | 1 | 2.4 | 2.2 | 1.9 | 1.6 | 1.4 | 1.2 | 1.0 | 0.8 | 0.6 | 0.5 | 0.4 | 0.3 | | |
| | 24CT7M | ---- | 1/4 | 1 | 1 | 3.4 | 3.1 | 2.8 | 2.3 | 2.1 | 1.8 | 1.6 | 1.4 | 1.2 | 1.0 | 0.8 | 0.7 | | |
| 3450 RPM | 3CT5M | 33CT5M | 1/3 | 1 | 1 | 4.2 | 4.0 | 3.8 | 3.4 | 3.2 | 3.0 | 2.9 | 2.8 | 2.7 | 2.6 | | | | |
| | 5CT5M | 35CT5M | 1/2 | 1 | 1 | 4.2 | 4.0 | 3.8 | 3.4 | 3.2 | 3.0 | 2.9 | 2.8 | 2.7 | 2.6 | 2.6 | 2.5 | 2.4 | 2.4 |
| | 3CT6M | 33CT6M | 1/3 | 1 | 1 | 6.0 | 5.7 | 5.3 | 4.8 | 4.6 | 4.4 | 4.3 | 4.2 | | | | | | |
| | 5CT6M | 35CT6M | 1/2 | 1 | 1 | 6.0 | 5.7 | 5.3 | 4.8 | 4.6 | 4.4 | 4.3 | 4.2 | 4.0 | 3.9 | 3.8 | 3.7 | | |
| | 7CT6M | 37CT6M | 3/4 | 1 | 1 | 6.0 | 5.7 | 5.3 | 4.8 | 4.6 | 4.4 | 4.3 | 4.2 | 4.0 | 3.9 | 3.8 | 3.7 | 3.7 | 3.6 |
| | 5CT7M | 35CT7M | 1/2 | 1 | 1 | 8.3 | 7.8 | 7.4 | 6.8 | 6.5 | 6.2 | 6.0 | 5.8 | 5.5 | | | | | |
| | 7CT7M | 37CT7M | 3/4 | 1 | 1 | 8.3 | 7.8 | 7.4 | 6.8 | 6.5 | 6.2 | 6.0 | 5.8 | 5.5 | 5.5 | 5.3 | 5.2 | 5.1 | 5.0 |
| | 5CT8M | 35CT8M | 1/2 | 1 | 1 | 11.7 | 11.0 | 10.5 | 9.7 | 9.3 | 8.9 | 8.5 | | | | | | | |
| 7CT8M | 37CT8M | 3/4 | 1 | 1 | 11.7 | 11.0 | 10.5 | 9.7 | 9.3 | 8.9 | 8.5 | | | | | | | | |

| 60 HZ - PERFORMANCE & SELECTION CHART | | | | | | | | | | | | | | | | | | | |
|---------------------------------------|---------|-----------------|----------------|----------------|------------|------------|-------------|-------------|-------------|-------------|-------------|-------------|-----------|-------------|-------------|-------------|-------------|-------------|---------------|
| Catalog Number | | HP | Tappings | | kPa Meters | TOTAL HEAD | | | | | | | | | | | | | |
| | | | Suct. NPT (in) | Disc. NPT (in) | | 59 6.1 | 119 12.1 | 179 18.2 | 299 30.5 | 373 38.1 | 447 45.7 | 523 53.3 | 597 61 | 672 68.6 | 747 76.2 | 821 83.8 | 896 91.4 | 966 99.1 | 1045 106.6 |
| 1 Phase | 3 Phase | CAPACITY IN LPS | | | | | | | | | | | | | | | | | |
| 1750 RPM | 24CT6M | ---- | 1/4 | 1 | 1 | 0.15 | 0.13 | 0.11 | 0.10 | 0.08 | 0.07 | 0.06 | 0.05 | 0.03 | 0.03 | 0.02 | 0.01 | | |
| | 24CT7M | ---- | 1/4 | 1 | 1 | 0.21 | 0.19 | 0.17 | 0.14 | 0.13 | 0.11 | 0.10 | 0.08 | 0.07 | 0.06 | 0.05 | 0.04 | | |
| 3450 RPM | 3CT5M | 33CT5M | 1/3 | 1 | 1 | 0.26 | 0.25 | 0.23 | 0.21 | 0.20 | 0.18 | 0.18 | 0.17 | 0.17 | 0.16 | | | | |
| | 5CT5M | 35CT5M | 1/2 | 1 | 1 | 0.26 | 0.25 | 0.23 | 0.21 | 0.20 | 0.18 | 0.18 | 0.17 | 0.17 | 0.16 | 0.16 | 0.15 | 0.15 | 0.15 |
| | 3CT6M | 33CT6M | 1/3 | 1 | 1 | 0.37 | 0.35 | 0.33 | 0.30 | 0.29 | 0.27 | 0.27 | 0.26 | | | | | | |
| | 5CT6M | 35CT6M | 1/2 | 1 | 1 | 0.37 | 0.35 | 0.33 | 0.30 | 0.29 | 0.27 | 0.27 | 0.26 | 0.25 | 0.24 | 0.23 | 0.23 | | |
| | 7CT6M | 37CT6M | 3/4 | 1 | 1 | 0.37 | 0.35 | 0.33 | 0.30 | 0.29 | 0.27 | 0.27 | 0.26 | 0.25 | 0.24 | 0.23 | 0.23 | 0.23 | 0.23 |
| | 5CT7M | 35CT7M | 1/2 | 1 | 1 | 0.52 | 0.49 | 0.46 | 0.42 | 0.41 | 0.39 | 0.37 | 0.36 | 0.34 | | | | | |
| | 7CT7M | 37CT7M | 3/4 | 1 | 1 | 0.52 | 0.49 | 0.46 | 0.42 | 0.41 | 0.39 | 0.37 | 0.36 | 0.34 | 0.34 | 0.33 | 0.32 | 0.32 | 0.31 |
| | 5CT8M | 35CT8M | 1/2 | 1 | 1 | 0.73 | 0.69 | 0.66 | 0.61 | 0.58 | 0.56 | 0.53 | | | | | | | |
| 7CT8M | 37CT8M | 3/4 | 1 | 1 | 0.73 | 0.69 | 0.66 | 0.61 | 0.58 | 0.56 | 0.53 | | | | | | | | |

NOTE: When pumping hot water over 180°F (82.2°C), check the NPSH available in the pumping system against the required pump NPSH shown on pump performance curves. Available NPSH must be greater than required NPSH.

Close Coupled Turbine Pumps

| 50 HZ - PERFORMANCE & SELECTION CHART | | | | | | | | | | | | | | | | | | | |
|---------------------------------------|-----------|-----------------|-----------|-----------|----------|------------|------------|----------|-------------|-------------|-------------|-------------|-------------|-------------|--------------|--------------|------------|--------------|--------------|
| Catalog Number | | HP | Tappings | | PSI Feet | TOTAL HEAD | | | | | | | | | | | | | |
| | | | Suct. NPT | Disc. NPT | | 8.6 20 | 17.2 40 | 26 60 | 43.3 100 | 54.1 125 | 64.9 150 | 75.8 175 | 86.6 200 | 97.4 225 | 108.3 250 | 119.1 275 | 130 300 | 140.1 325 | 151.6 350 |
| 1 Phase | 3 Phase | CAPACITY IN GPM | | | | | | | | | | | | | | | | | |
| | L33CT5M | 0.58 | 1 | 1 | | 3.2 | 3.0 | 2.8 | 2.5 | 2.3 | | 2.1 | 2.05 | 2.0 | 1.9 | 1.8 | 1.7 | 1.6 | 1.6 |
| | L35CT5M | 0.8 | 1 | 1 | | 3.2 | 3.0 | 2.8 | 2.5 | 2.3 | 2.2 | 2.1 | 2.05 | 2.0 | 1.9 | 1.8 | 1.7 | 1.6 | 1.6 |
| | L33CT6M | 0.58 | 1 | 1 | | 4.8 | 4.4 | 4.0 | | | | | | | | | | | |
| | L35CT6M | 0.8 | 1 | 1 | | 4.8 | 4.4 | 4.0 | 3.6 | 3.4 | 3.2 | 3.1 | | | | | | | |
| | TL310CT6M | 1.0 | 1 | 1 | | 4.8 | 4.4 | 4.0 | 3.6 | 3.4 | 3.2 | 3.1 | 3.0 | 2.9 | 2.8 | 2.8 | 2.7 | | |
| | L37CT6M | 1.13 | | | | 4.8 | 4.4 | 4.0 | 3.6 | 3.4 | 3.2 | 3.1 | 3.0 | 2.9 | 2.8 | 2.8 | 2.7 | 2.7 | |
| | L35CT7M | 0.8 | 1 | 1 | | 6.6 | 6.2 | 5.6 | 5.1 | 4.6 | 4.7 | | | | | | | | |
| | TL310CT7M | 1.0 | 1 | 1 | | 6.6 | 6.2 | 5.6 | 5.1 | 4.6 | 4.7 | 4.5 | 4.4 | 4.2 | | | | | |
| | L37CT7M | 1.13 | | | | 6.6 | 6.2 | 5.6 | 5.1 | 4.6 | 4.7 | 4.5 | 4.4 | 4.2 | 4.1 | 3.9 | | | |
| L10CT7M | --- | 1.3 | 1 | 1 | | 6.6 | 6.2 | 5.6 | 5.1 | 4.8 | 4.7 | 4.5 | 4.4 | 4.2 | 4.1 | 3.9 | 3.8 | 3.7 | |

2900 RPM

| 50 HZ - PERFORMANCE & SELECTION CHART | | | | | | | | | | | | | | | | | | | |
|---------------------------------------|-----------|-----------------|----------------|----------------|------------|------------|-------------|-------------|-------------|-------------|-------------|-------------|-----------|-------------|-------------|-------------|-------------|-------------|---------------|
| Catalog Number | | HP | Tappings | | kPa Meters | TOTAL HEAD | | | | | | | | | | | | | |
| | | | Suct. NPT (in) | Disc. NPT (in) | | 59 6.1 | 119 12.1 | 179 18.2 | 299 30.5 | 373 38.1 | 447 45.7 | 523 53.3 | 597 61 | 672 68.6 | 747 76.2 | 821 83.8 | 896 91.4 | 966 99.1 | 1045 106.6 |
| 1 Phase | 3 Phase | CAPACITY IN LPS | | | | | | | | | | | | | | | | | |
| | L33CT5M | 0.58 | 1 | 1 | | 0.20 | 0.18 | 0.17 | 0.15 | 0.14 | | | | | | | | | 0.10 |
| | L35CT5M | 0.8 | 1 | 1 | | 0.20 | 0.18 | 0.17 | 0.15 | 0.14 | 0.13 | 0.13 | 0.12 | 0.12 | 0.11 | 0.11 | 0.10 | 0.10 | |
| | L33CT6M | 0.58 | 1 | 1 | | 0.30 | 0.27 | 0.25 | | | | | | | | | | | |
| | L35CT6M | 0.8 | 1 | 1 | | 0.30 | 0.27 | 0.25 | 0.22 | 0.21 | 0.20 | 0.19 | | | | | | | |
| | TL310CT6M | 1.0 | 1 | 1 | | 0.30 | 0.27 | 0.25 | 0.22 | 0.21 | 0.20 | 0.19 | 0.18 | 0.18 | 0.17 | 0.17 | 0.17 | 0.17 | |
| | L37CT6M | 1.13 | | | | 0.30 | 0.27 | 0.25 | 0.22 | 0.21 | 0.20 | 0.19 | 0.18 | 0.18 | 0.17 | 0.17 | 0.17 | 0.17 | |
| | L35CT7M | 0.8 | 1 | 1 | | 0.41 | 0.39 | 0.35 | 0.32 | 0.29 | 0.29 | | | | | | | | |
| | TL310CT7M | 1.0 | 1 | 1 | | 0.41 | 0.39 | 0.35 | 0.32 | 0.29 | 0.29 | 0.28 | 0.27 | 0.26 | | | | | |
| | L37CT7M | 1.13 | | | | 0.41 | 0.39 | 0.35 | 0.32 | 0.29 | 0.29 | 0.28 | 0.27 | 0.26 | 0.25 | 0.24 | | | |
| L10CT7M | --- | 1.3 | 1 | 1 | | 0.41 | 0.39 | 0.35 | 0.32 | 0.30 | 0.29 | 0.28 | 0.27 | 0.26 | 0.25 | 0.24 | 0.23 | 0.23 | |

2900 RPM

NOTE: When pumping hot water over 180°F (82.2°C), check the NPSH available in the pumping system against the required pump NPSH shown on pump performance curves. Available NPSH must be greater than required NPSH.

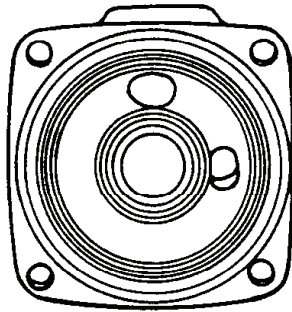
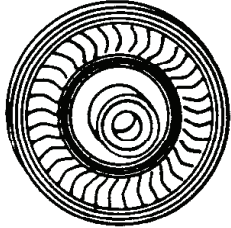
Close Coupled Turbine Pumps

BURKS close coupled turbine pumps, Series CT, 3450 (60Hz) and 2900 (50Hz) R.P.M. and 4CT, 1725 R.P.M. are available for capacities up to 8 g.p.m. (0.50 L.P.S.) - pressures up to 150 p.s.i. (1034 kpa) and temperatures up to 225°F (107°C), come with standard mechanical shaft seal. Special shaft seals are available for higher temperatures and fluids other than water.

These compact turbine pumps are designed for pumping clear water and many other non-abrasive, lower viscosity liquids. They are especially engineered for boiler feed on steam process applications and will serve up to a 38 hp. boiler at a 3 to 1 safety factor. Available in bronze fitted as standard. All bronze or stainless steel construction also available. These pumps are recommended for many application requiring higher pressures and lower capacities.

BURKS is the only turbine pump with Life-Lok® External Impeller Adjustment feature that allows readjustment of impeller without disturbing piping, disassembling pump or replacing parts. Gives up to 40% longer service life than turbine pumps of other designs.

MAXIMUM OPERATING CONDITIONS

| | |
|---|-------------------|
| TEMPERATURE (For Standard Buna-N Seal) | 225°F (107°C) |
| INLET PRESSURE | 100 PSI (689kPa) |
| CASING WORKING PRESSURE | 250 PSI (1723kPa) |
| VISCOSITY | 200 SSU |

MOTOR INFORMATION

Standard pump motors have open drip proof construction and are rated with jet pump service factors for continuous duty operation at all ratings shown. Single phase motors are 115/230 volt, 60 Hz, capacitor start/induction run with built-in overload protection. Single phase motors 1/3, 1/2 & 3/4 HP are U.L. recognized. Three phase motors require a magnetic type starter which provides full 3-leg overload protection. Failure to use the correct starter and overloads will void the warranty. All three phase motors are 208-230/460 volt, 60/50Hz, 3450/2900 RPM.

FOR TEMPERATURES TO 500°F (260°C).

Series CT Pumps are available in a Jacketed Seal Cavity design for pumping hot oil, hot water and heat transfer fluids in common use in high temperature heating or cooling applications. This feature greatly extends seal life in high temperature applications. To order, add suffix "J" to pump catalog number for temperatures below 400°F (204°C) and add suffix "JK" to pump catalog number for temperatures over 400°F (204°C). Example: 5CT5MJ. See Section on High Temperature Pumps for more information.

MATERIALS OF CONSTRUCTION

| PART | BRONZE FITTED | ALL BRONZE | STAINLESS STEEL |
|------------|-------------------------------|-------------------------------|-------------------------------|
| Frame | Cast Iron | Bronze | #316 Stainless |
| Impeller | Bronze (Monel Blades) | Bronze (Monel Blades) | #303 Stainless |
| Raceway | Bronze | Bronze | #303 Stainless |
| Shaft | #316 Stainless | #316 Stainless | #316 Stainless |
| Shaft Seal | Carbon-Ceramic SS - Buna-N | Carbon-Ceramic SS - Buna-N | Carbon-Ceramic SS - Buna-N |

Close Coupled Turbine Pumps

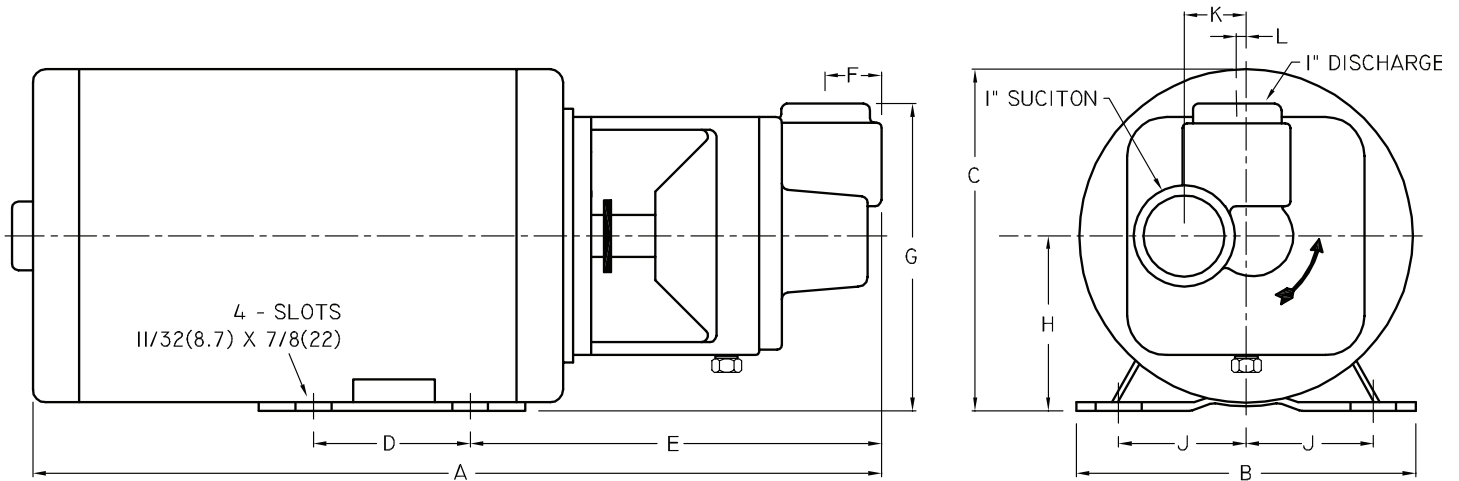

| DIMENSIONS IN INCHES (mm) | | | | | | | | | | | | | | | | | | | |
|---------------------------|-------------------|--------------|--------------|--------------|---------------------|--------------|---------------------|-------------|-------------|-----------|-------------|----------------|-----------|-------------|-------------|------------|---------------|---------------|---------------|
| Series | HP | Tappings | | 1 PH A | 1 PH A (S.S.) | 3 PH A | 3 PH A (S.S.) | B | C | D | E | E (S.S.) | F | F (S.S.) | G | H | J | K | L |
| | | Disc. NPT | Suct. NPT | | | | | | | | | | | | | | | | |
| 4CT | 1/4 | 1 | 1 | 16¼ (413) | 16.675 (424) | --- | --- | 6½ (165) | 6⅝ (168) | 3 (76) | 7⅞ (200) | 8⅝/16 (211) | 1 (25) | 1 (25) | 5⅞ (149) | 3½ (89) | 2⅞/16 (62) | 1⅝/32 (29) | ⅜/16 (4.8) |
| CT | 1/3 1/2 3/4 | 1 1 1 | 1 1 1 | 16¼ (413) | 16.675 (424) | 16¼ (413) | 16.675 (424) | 6½ (165) | 6⅝ (168) | 3 (76) | 7⅞ (200) | 8⅝/16 (211) | 1 (25) | 1 (25) | 5⅞ (149) | 3½ (89) | 2⅞/16 (62) | 1⅝/32 (29) | ⅜/16 (4.8) |

Dimensions shown above are approximate maximum dimensions for standard pumps equipped with open drip-proof motors.

A strainer, approximately 20 mesh, should be installed on the suction side of the pump to prevent chips, scale or hard foreign particales from entering the pump and damaging the raceway and impeller.

Series: CT

60 Hz Performance



www.cranepumps.com

Close Coupled Turbine Pumps

3450 RPM

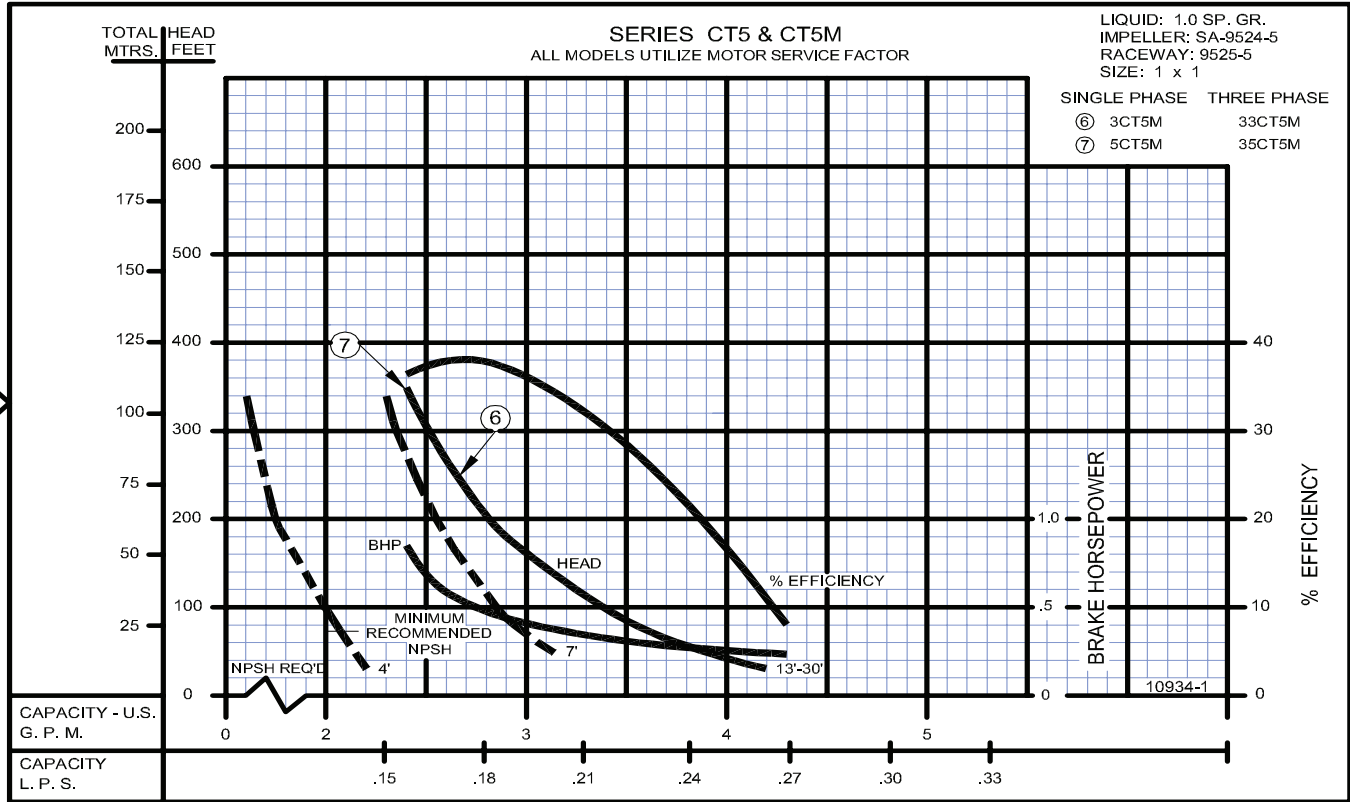

SECTION 5B
PAGE 6
DATE 1/06



A Crane Co. Company

PUMPS & SYSTEMS

USA: (937) 778-8947 • Canada: (905) 457-6223 • International: (937) 615-3598

Close Coupled Turbine Pumps

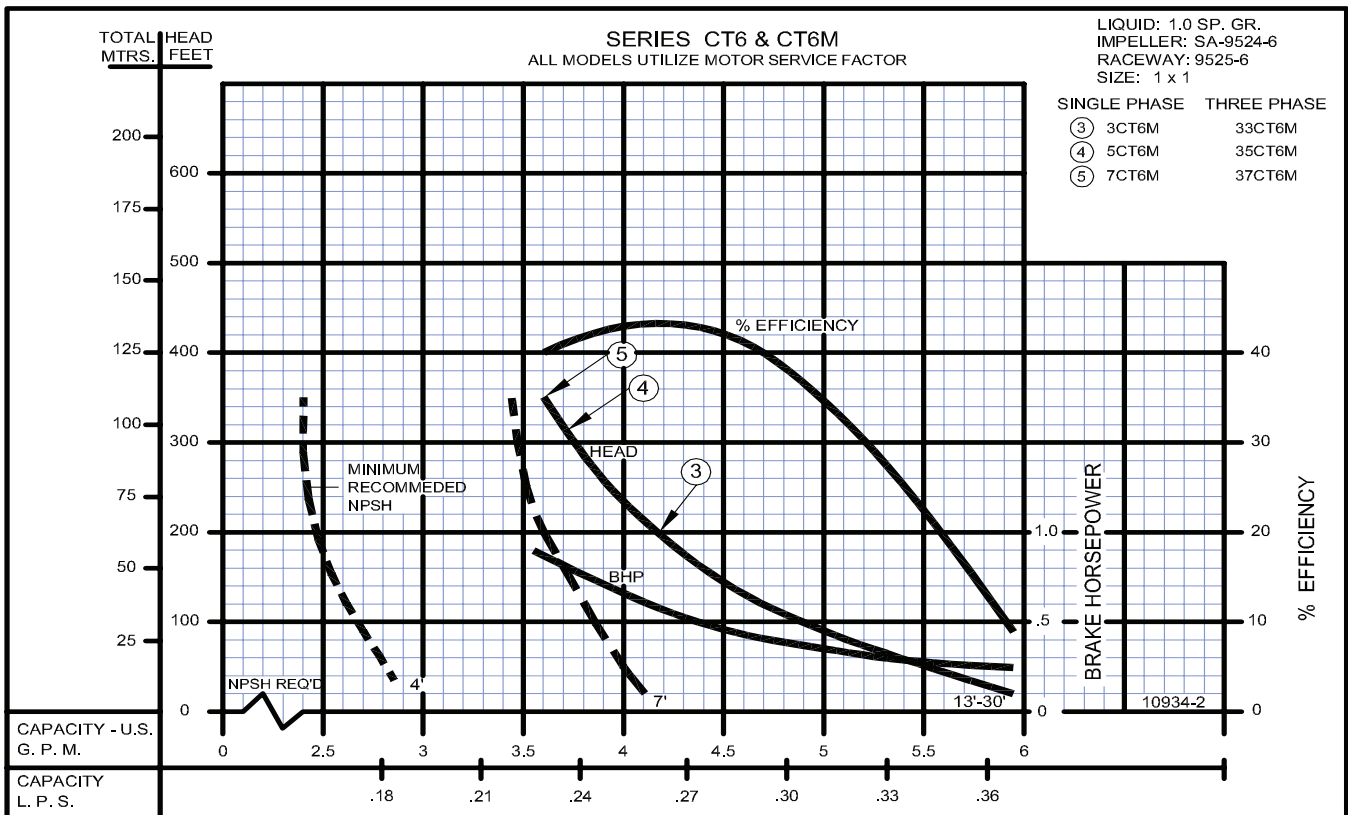
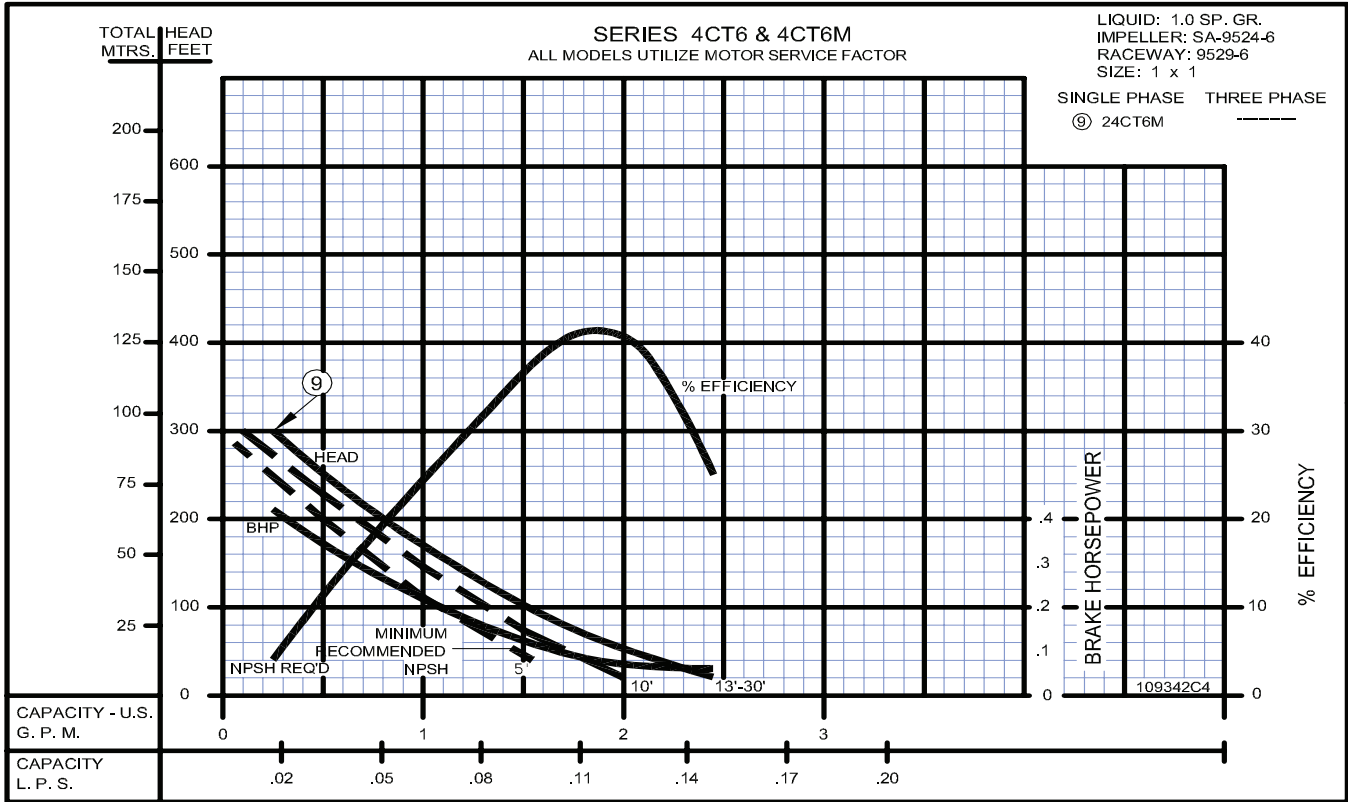

Close Coupled Turbine Pumps

1725 RPM

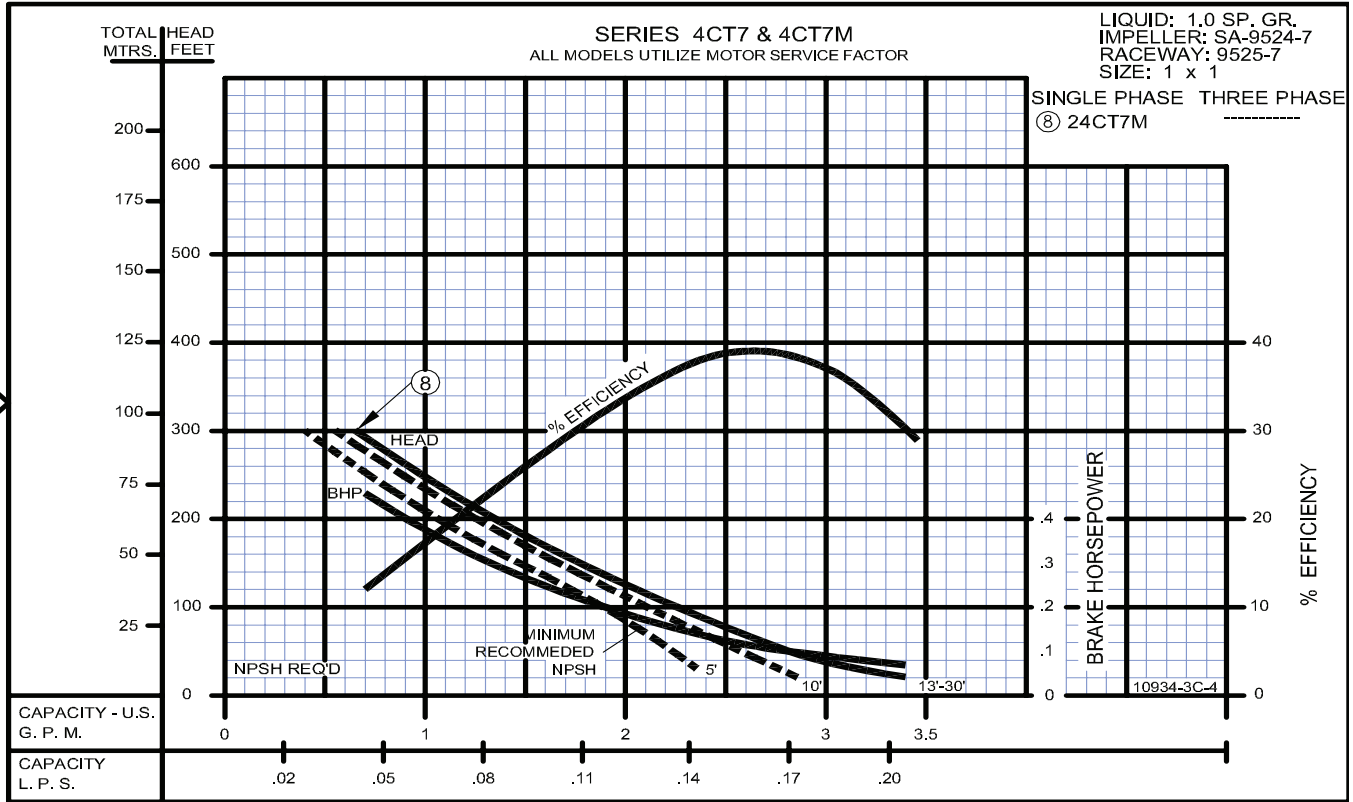

3450 RPM

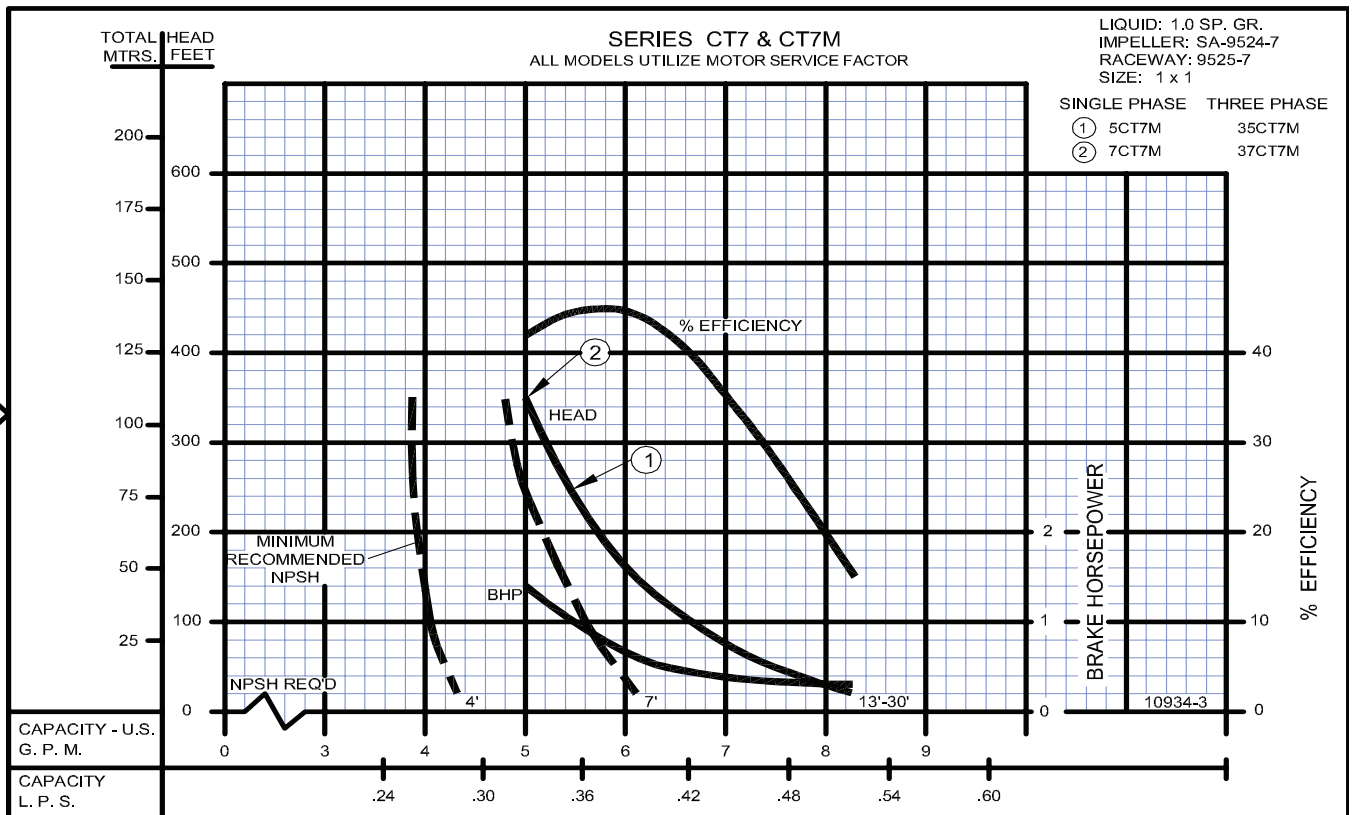

Close Coupled Turbine Pumps

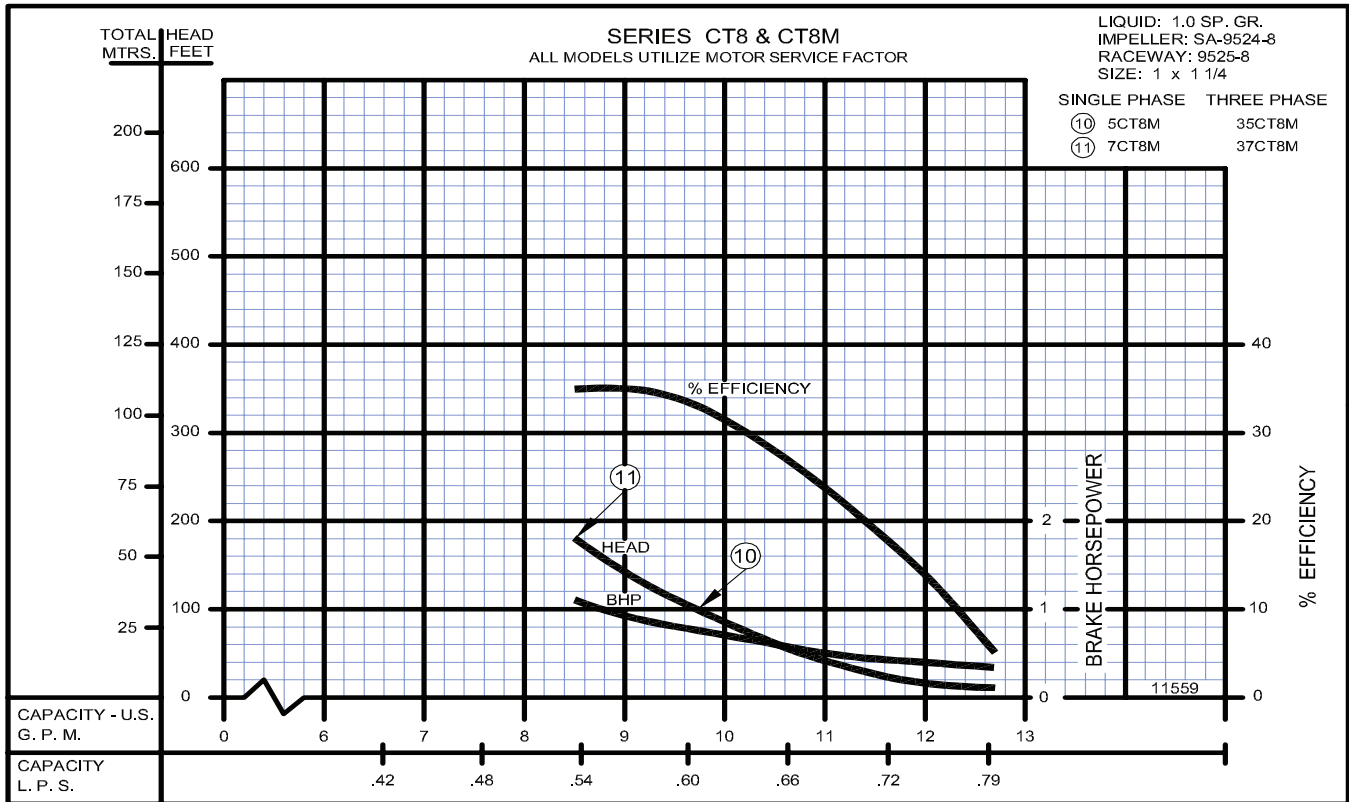

Series: CT

50 Hz. Performance



www.cranepumps.com

Close Coupled Turbine Pumps

2900 RPM

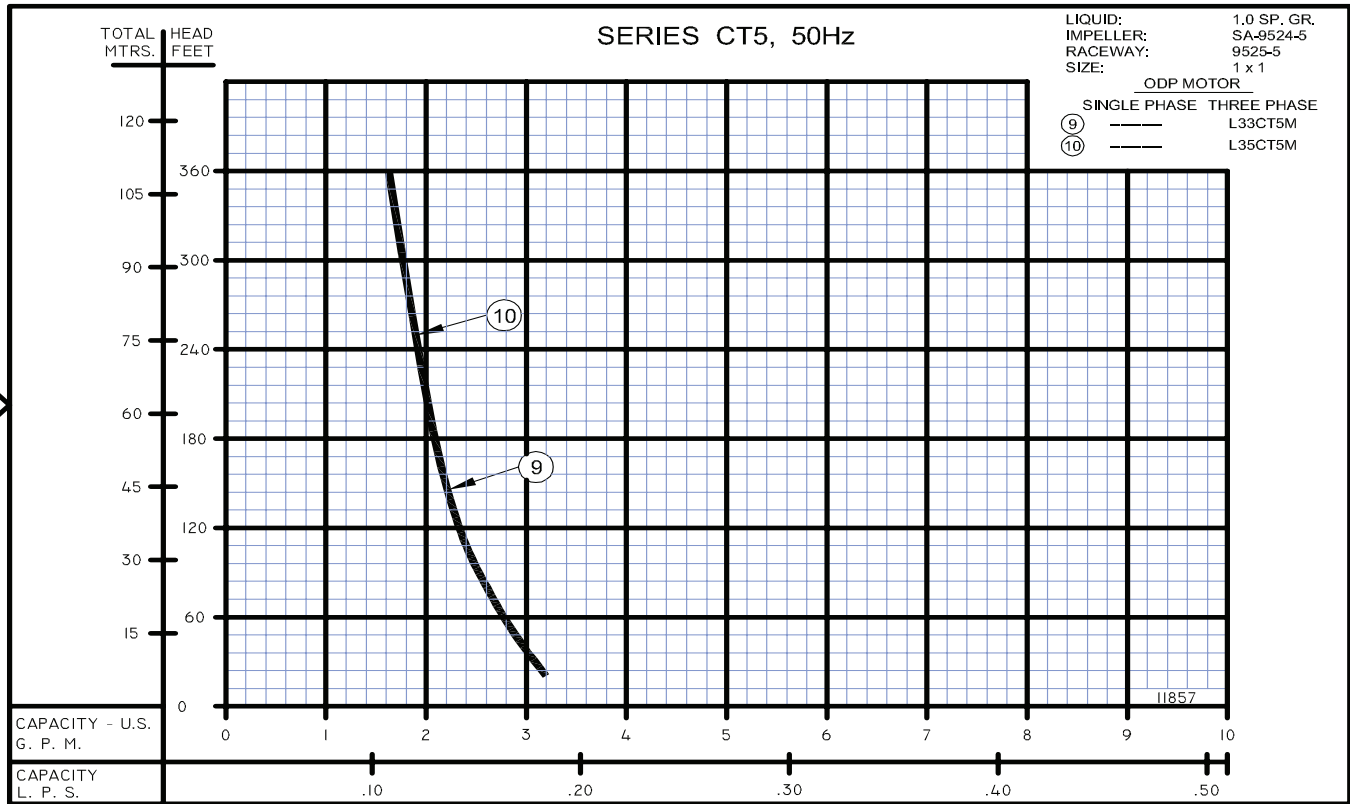

2900 RPM

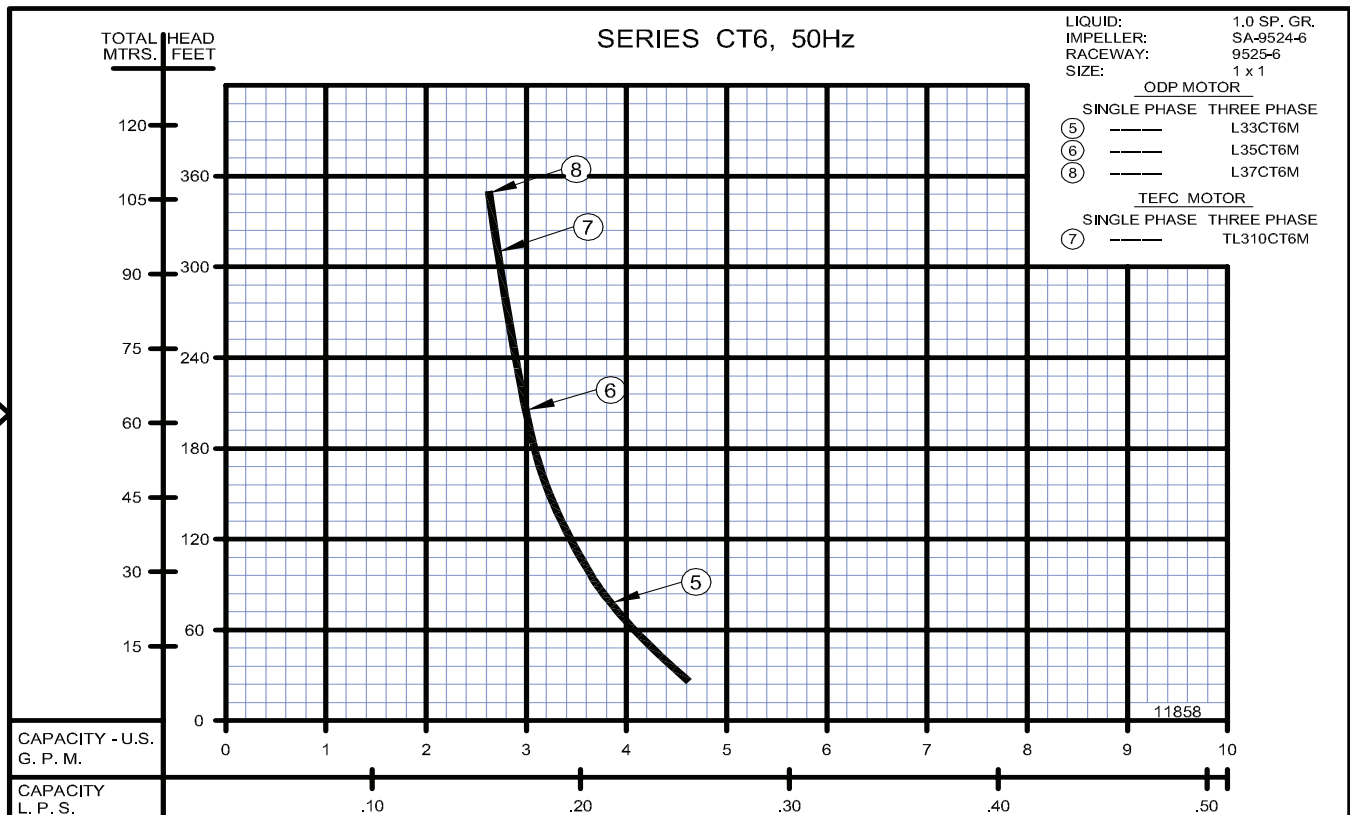

SECTION 5B
PAGE 10
DATE 1/06



PUMPS & SYSTEMS

A Crane Co. Company

USA: (937) 778-8947 • Canada: (905) 457-6223 • International: (937) 615-3598

Close Coupled Turbine Pumps

