

Please read and save this Repair Parts Manual. Read this manual and the General Operating Instructions carefully before attempting to assemble, install, operate or maintain the product described. Protect yourself and others by observing all safety information. The Safety Instructions are contained in the General Operating Instructions. Failure to comply with the safety instructions accompanying this product could result in personal injury and/or property damage! Retain instructions for future reference. AMT reserves the right to discontinue any model or change specifications at any time without incurring any obligation.

©2012 American Machine & Tool Co., Inc. of PA, A Subsidiary of The Gorman-Rupp Company, All Rights Reserved.

Periodic maintenance and inspection is required on all pumps to insure proper operation. Unit must be clear of debris and sediment. Inspect for leaks and loose bolts. Failure to do so voids warranty.

Patterson/AMT Inline Circulator Pumps

Refer to pump manual 1808-634-00 for General Operating and Safety Instructions.

DESCRIPTION

Patterson/AMT Inline Circulator Pumps are designed for continuous duty industrial/commercial applications. Pumps are designed for liquid circulation in HVAC and industrial/commercial systems. Pumps are available in cast iron or bronze configurations to meet your specification. Pump casing is equipped with c" NPT suction and discharge gauge ports. Pumps are powered by a 56C NEMA frame electric motor with ½" conduit connection. Pump is equipped with precision lapped mechanical shaft seal to reduce the likelihood of leakage, o-ring sealed casing, and a bronze closed impeller. Liquid temperature range is 40° to 200° F (4° to 93° C. Liquid viscosity and specific gravity must be close to water; 31 SSU and 1.00. Maximum casing pressure is 150 psi. Pump shipped with NPT flanges, flange gaskets and flange installation hardware.

All single phase motors are equipped with automatic thermal protection. Overload protection is recommended for three phase motors but is not supplied. Check motor wiring before putting unit into service (see motor nameplate for specific wiring diagram). These are manual units, no controls are supplied.

▲ WARNING

All units are for use with non-flammable, non-abrasive liquids compatible with pump component materials.

IMPORTANT: Not for use with petroleum based liquids.

CAST IRON UNITS (-95)

Pump construction is cast iron casing, seal plate and adapter. Cast bronze impeller. EPDM type 21 mechanical shaft seal with carbon and ceramic wear faces. EPDM O-ring casing seal.

BRONZE UNITS (-97)

Pump construction is cast bronze casing and seal plate with cast iron adapter. Cast bronze impeller. EPDM type 21 mechanical shaft seal with carbon and ceramic wear faces. EPDM O-ring casing seal.

UNPACKING

Refer to Repair Parts Illustration and Repair Parts List to aid in identifying parts. Unpack and separate all pump components from shipping/packaging materials, making sure all parts are accounted for. Retain all manuals for reference. Package should contain: pump, flanges, circulator pump specific manual, and general pump manual.

INSTALLATION

1. Pump is designed for circulating liquid in a closed system for a flooded suction application. Pump will not Self-prime.
2. Piping system must be designed for adequate thermal expansion.
3. A pressure relief valve should be considered to protect pump casing from over pressurization and pressure spikes especially if a check valve is installed near pump.
4. Locate the pump so that there is sufficient room for maintenance and servicing.
5. There must be a sufficient supply of cooling air and ventilation around the

pump and motor to avoid excessive component temperatures.

6. Installing a shutoff valve in both the suction and discharge piping will make removal and servicing of the pump possible without draining the entire system.
7. Support the piping near the pump's suction and discharge with sufficient piping hangers. This will minimize pipe strain.

NOTE: Proper motor support is required to avoid damage to pump or motor. Use correct size motor hanger similar to the one pictured based on model being installed. Hangers vary depending on horizontal or vertical installation (see figure 1).



Figure 1 - Piping Hanger & Support

8. Make sure bolt holes in pipe flange line up with bolt holes in pump flange.

▲ CAUTION

Do not spring the suction or discharge piping into position. This will result in excessive stain in the piping, flanges and pump casing.

ORIENTING PUMP

1. The pump can be oriented in any desired position: discharge up or down, left or right.
2. If motor is oriented vertically up, a means of venting air from the seal chamber must be installed in the seal plate (Ref. No. 8) 1/8" NPT port. Remove 1/8" NPT plug (Ref. No. 6) and install air venting device or liquid injection line.
3. **DO NOT INSTALL UNIT** with motor vertically down, any liquid breaching the mechanical shaft seal will run directly down shaft into motor.

NOTE: Proper motor support is required to avoid damage to pump or motor. Use correct size motor hanger similar to the one pictured based on model being installed. Hangers vary depending on horizontal or vertical installation (see figure 1).

Patterson/AMT Inline Circulator Pumps

INSTALLING FLANGES

1. Included with pump: (2) 1.5" NPT flanges, 2 gaskets, and 4 bolts, nuts, and washers.
2. Install flanges on piping using sealing tape or pipe sealant.
3. Insert gasket into machined groove on pump flange.
4. Position pump by lining up bolt holes on pump flange with bolt holes on pipe flange.
5. Install 4 hex head bolts, nuts, and washers. Torque both flange bolts in even increments to a value of 8-11 ft-lbs (1.1-1.5 Kg-m). Torque the bolts in both the suction and discharge flanges in this manner.

OPERATION

1. Prior to pump start up ensure system is clean and filled with clean liquid that is compatible with pump components.
2. Pressurize the pump body slowly. Check for leaks at the flange joint, the pump casing, and motor shaft.

⚠ CAUTION

Pressurize pump casing slowly. Failure to check for leaks at all joints sealed with a gasket may result in personal injury or property damage. Installation of a collection pan and/or drain is required to prevent property damage from system leaks.

3. **Do not run pump dry!** Mechanical shaft seal damage will occur if pump is run dry. Pump body must be filled with liquid before starting motor. Air must be vented from the system by means of an air vent located at a high point in the system.

MAINTENANCE

⚠ WARNING

Make certain that the unit is disconnected and locked out from the power source before attempting to service or remove any components.

1. System must be drained or pump isolated by turning off suction and discharge valves before attempting to remove pump.

⚠ WARNING

Water temperature in system can not exceed 100°F (38°C) before removing or servicing pump. If draining system leave drain valve open during servicing.

⚠ CAUTION

Pump surface temperature can not exceed 90°F (32°C) before removing or servicing pump.

⚠ WARNING

Loosen flange bolts slightly and shift pump side to side to vent internal pump casing pressure before removing or servicing pump.

2. Remove pump from the system by removing four flange mounting bolts, nuts, and washers (Ref. Nos. 24 & 25).

REMOVAL OF MOTOR

(Refer to Figure #1 for part identification)

Motor may be removed from pump and replaced without draining and removing the entire pump. If motor troubles are a result of shaft seal failure, the shaft

seal must be replaced before installing a replacement motor. See Shaft Seal Replacement section of this manual.

1. Lock out and disconnect power supply.
2. Remove four bolts (Ref. No. 3) fastening motor (Ref. No. 1) to adapter (Ref. No. 2).
3. Rotate shaft until stub shaft set screw (Ref. No. 26) is visible in access slot in adapter (Ref. No. 2). Loosen set screw
4. Slide motor from adapter and stub shaft (Ref. No. 6). Remove square key (Ref. No. 5).

INSTALLATION OF NEW MOTOR

1. Apply anti-seize compound to motor shaft bore in stub shaft.
2. Position square key in motor shaft bore Keyway of stub shaft.
3. Align motor shaft Keyway with square key.
4. Slide motor into stub shaft until motor mounting face is contacting adapter face.
5. Install four motor mounting bolts.
6. Securely tighten stub shaft set screw.

SHAFT SEAL REPLACEMENT

Refer to figures Nos. 2

REMOVAL OF OLD SEAL

IMPORTANT: Always replace both seal seat (Ref. No. 11) and seal head (Ref. No. 12) to ensure proper mating of components! Also, impeller seals (Ref. Nos. 14 and 17) should be replaced anytime impeller (Ref. No. 16) has been removed.

1. Remove fasteners (Ref. No. 4) connecting casing (Ref. No. 20) to adapter (Ref. No. 2).
2. Slide casing off of seal plate (Ref. No. 10) locating boss. Take care when removing casing, it may be heavy.
3. Use a hex wrench to remove impeller fastener (Ref. No. 18). Remove impeller (Ref. No. 16) from stub shaft (Ref. No. 6).
4. Remove shaft sleeve (Ref. No. 13) from stub shaft. Remove old seal head from shaft sleeve.
5. Disconnect any piping or venting apparatus attached to seal plate 1/8" NPT wash/vent port.
6. Remove seal plate (Ref. No. 10) from adapter.
7. Remove shaft washer (Ref No. 8) from stub shaft.
8. Inspect exposed sealed ball bearing. If bearing is worn or has been exposed to liquid that has leaked from inside pump, the bearing must be replaced. See Shaft Bearing Replacement section of this manual.
9. Pry seal seat from cavity in seal plate.

INSTALLATION OF NEW SEAL

⚠ CAUTION

The precision lapped faces on mechanical seal are easily damaged. Handle your repair seal carefully. Do not touch polished seal faces.

IMPORTANT: Be sure that shaft should does not damage polished face.

1. Thoroughly clean all surfaces of seal cavity in adapter.
2. Using a clean cloth, wipe shaft and make certain that it is perfectly clean
3. Wet rubber portion of new seal seat with a light coating of soapy water. While wearing clean gloves or using a clean light rag, press seal seat

Patterson/AMT Inline Circulator Pumps

- squarely into adapter recess. Use cardboard washer (usually supplied with new seal), place over polished surface and use a piece of pipe or dowel rod to press in firmly but gently. Avoid scratching polished face
- Dispose of cardboard washer. Check again to see that polished face is free of dirt and all other foreign particles and that it has not been scratched or damaged.
 - Install shaft washer onto stub shaft.
 - Install seal plate onto stub shaft, align seal plate on shaft bearing, align 1/8" NPT seal wash/vent port with opening in adapter. Seat seal plate firmly against adapter.
 - Install shaft sleeve onto stub shaft until it bottoms against shaft washer.
 - Wet inside rubber portion of new seal head with a light coating of soapy water. Slide head onto shaft sleeve with sealing surface facing seal seat. Push head onto shaft sleeve until it lightly touches the seal seat. Make sure seal head spring is in position.
 - Install impeller seal (Ref. No. 14) into machined counter-bore in impeller hub. Install impeller seal (Ref. No. 17) into machined counter-bore in impeller nose.
 - Apply anti-seize compound to impeller hub shaft bore.
 - Position square key (Ref. No. 15) in impeller hub shaft bore Keyway.
 - Align stub shaft keyway with square key. Install impeller on stub shaft compressing seal head spring.
 - Install impeller fastener through impeller nose into stub shaft. Tighten with hex wrench. Make certain impeller is fully seated against shaft sleeve end.
 - Check if shaft turns freely by spinning the impeller.
 - Place casing seal on seal plate locating boss. Slide casing onto seal plate.
 - Attach casing using fasteners. Spin motor shaft to check for interference with casing.

NOTE: A short "run-in" period may be necessary to provide completely leak-free operation.

⚠ CAUTION

Seal will produce minor drag when spinning motor shaft, but rubbing anywhere else must be eliminated! Otherwise, damage to pump and/or motor may occur.

SHAFT BEARING REPLACEMENT

Pump is constructed with a bearing supported stub shaft to allow removal of motor without draining pump casing. Bearing is a permanently lubricated sealed ball bearing. If bearing is worn or is exposed to liquid, from a leaking shaft seal for instance, it must be replaced.

REMOVAL OF OLD SHAFT BEARING

- Follow steps 1 through 8 in REMOVAL OF OLD SEAL section.
- Remove fasteners (Ref. No. 3) holding adapter (Ref. No. 2) to motor (Ref. No. 1).
- Loosen stub shaft set screw.
- Remove adapter, stub shaft, and bearing sub-assembly from motor.
- Remove stub shaft/bearing subassembly from adapter.
- Remove bearing from stub shaft.

INSTALLATION OF NEW SHAFT BEARING

- Position new bearing onto stub shaft. Press squarely onto stub shaft until bearing bottoms against shoulder.

- Position stub shaft/bearing subassembly onto adapter bearing bore. Press squarely into bearing bore until bearing bottoms.
- Apply anti-seize compound to motor shaft bore in stub shaft.
- Position square key (Ref. No. 5) in stub shaft motor bore keyway.
- Align motor shaft keyway with square key. Install stub shaft/bearing adapter sub-assembly onto motor until adapter is fully seated against motor face.
- Securely tighten stub shaft set screw.
- Secure adapter to motor with fasteners.
- Follow steps 5 through 16 in INSTALLATION OF NEW SEAL section

PUMP PIPING

- Proper system design and installation by a qualified engineer is recommended.
- Always start piping from pump.
- Use as few bends as possible and preferably long radius elbows.
- Do not use flexible connectors on the suction or discharge of a vertical in-line pump unless the pump is rigidly mounted to a foundation.
- Ensure piping exerts no strain on pump as this could distort the casing causing breakage or early failure due to pump misalignment.
- All connecting pipe flanges must be square to the pipe work and parallel to the pump flanges.
- Eliminate all air pockets that may prevent the pump from operating effectively.
- In open systems, test suction line for air leaks before starting; this becomes essential with long suction line or static lift.
- Install valves in both suction and discharge lines to assist with pump inspection or repair. Suction line valve may be opened completely during operation.
- Install a non-slam non-return check valve in discharge line between pump and isolation valve to protect pump from excessive back pressure and to prevent water running back through the pump on open systems.
- Before starting pump, the system must be thoroughly cleaned, flushed and drained and replenished with clean liquid.
- Welding slag and other foreign materials, improper or excessive water treatment are all detrimental to the pump internals and sealing arrangement and void warranty.
- Proper operation cannot be guaranteed if the above conditions are not adhered to.

NOTE: INSPECT THE FOLLOWING BEFORE PUTTING PUMP INTO OPERATION:

- Pump primed; liquid in pump.
- Rotation.
- System piping and pump properly supported.
- System clean of all debris.
- Proper electrical connections. Consult qualified electrician with any questions.
- Proper motor support is required to avoid damage to motor or pump see page 1, Installation & orienting sections

IMPORTANT: SYSTEM MUST BE FREE OF ALL PETROLEUM BASED LIQUID OR SUBSTANCE TO AVOID SEAL FAILURE, WHICH CAN ALSO LEAD TO PREMATURE MOTOR BEARING FAILURE. FAILURE TO COMPLY VOIDS WARRANTY.

Patterson/AMT Inline Circulator Pumps

For Repair Parts contact dealer where pump was purchased.

Please provide following information:

-Model Number

-Serial Number (if any)

Part description and number as shown in parts list

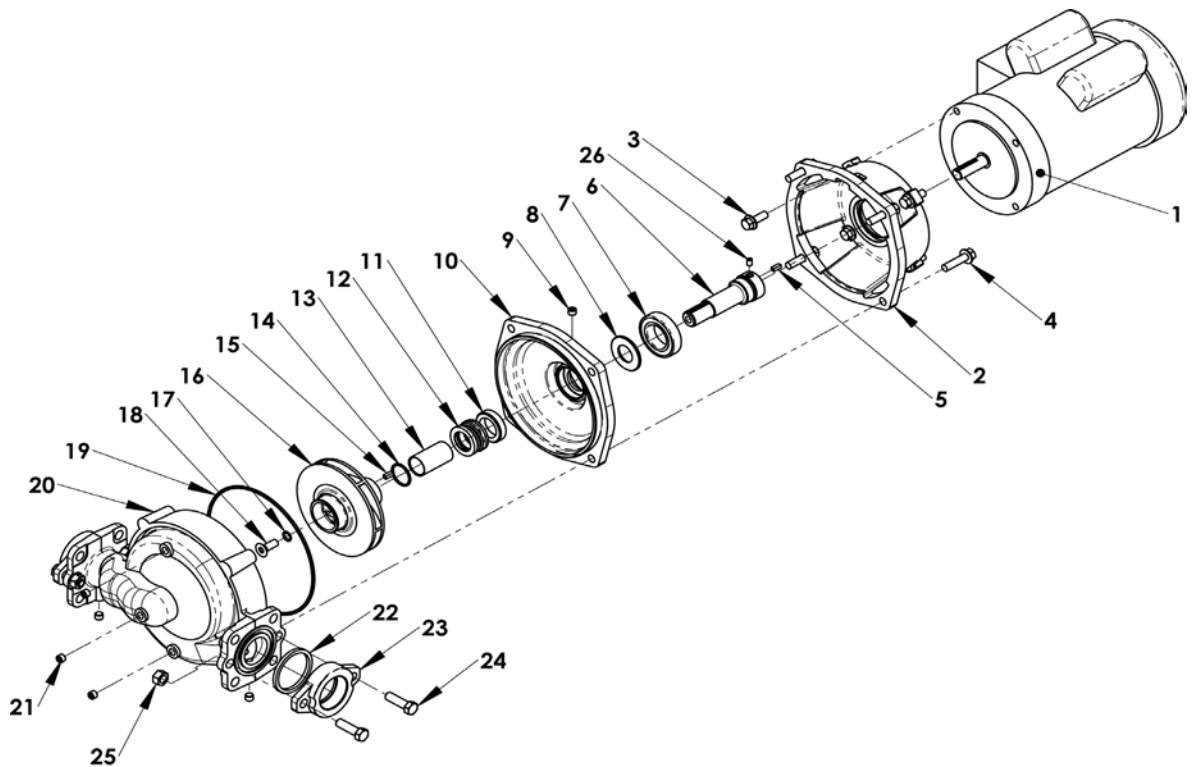

Figure 2 - Repair Parts Illustrations

Repair Parts List - Motor

Ref. No.	Description	1/3 HP	1/2 HP	3/4 HP	1 HP	1.5 HP	2 HP
1	Motor - 1 Phase	1626-005-00	1626-029-00	1626-006-00	1626-030-00	1626-095-00	1626-033-00
	Motor - 3 Phase	1626-021-00	1626-031-00	1626-022-00	1626-032-00	1626-039-00	1626-034-00

Repair Parts List - Impeller Kit

Ref. No.	Description	5864, 5865	5862, 5863	5860, 5861	5874, 5875	5872, 5873	5870, 5871	5886, 5887	5884, 5885	5882, 5883	5880, 5881
15,16 & 18	Impeller Kit	5864-010-97	5862-010-97	5860-010-97	5874-010-97	5872-010-97	5870-010-97	5886-010-97	5884-010-97	5882-010-97	5880-010-97

Repair Parts List - General

Ref No.	Description	586 Series			587 Series		5886-95 & 5887-95		5880-97 & 5887-97		5880-95 thru 5885-95		5880-97 thru 5885-97		Qty
		Cast Iron	Cast Bronze	Cast Iron	Cast Iron	Cast Bronze	5886-95 & 5887-95	5887-95	5886-97 & 5887-97	5880-95 thru 5885-95	5880-97 thru 5885-97				
2,3	Adapter Kit	5860-030-95	5860-030-95	5860-030-95	5860-030-95	5860-030-95	5860-030-95	5860-030-95	5860-030-95	5860-030-95	5860-030-95	5860-030-95	5860-030-95	1	
5,6,7,8, 26	Stub Shaft Kit	5860-140-90	5860-140-90	5860-140-90	5860-140-90	5860-140-90	5860-140-90	5860-140-90	5860-140-90	5860-140-90	5860-140-90	5860-140-90	5860-140-90	1	
7	Bearing #6007	3354-193-00	3354-193-00	3354-193-00	3354-193-00	3354-193-00	3354-193-00	3354-193-00	3354-193-00	3354-193-00	3354-193-00	3354-193-00	3354-193-00	1	
9,10	Seal Plate Kit	5860-020-95	5860-021-97	5860-020-95	5860-021-97	5860-020-95	5860-021-97	5860-020-95	5860-021-97	5860-020-95	5860-021-97	5860-020-95	5860-021-97	1	
11,12,13, 14,17,19	Seal Kit	5860-300-90	5860-300-90	5860-300-90	5860-300-90	5860-300-90	5860-300-90	5860-300-90	5860-300-90	5860-300-90	5860-300-90	5860-300-90	5860-300-90	1	
20,21,4	Casing Kit	5860-001-95	5860-002-97	5870-001-95	5870-002-97	5870-001-95	5870-002-97	5880-001-95	5880-002-97	5880-001-95	5880-002-97	5880-001-95	5880-002-97	1	
22	Flange Gasket Kit	5860-301-90	5860-301-90	5860-301-90	5860-301-90	5860-301-90	5860-301-90	5860-301-90	5860-301-90	5860-301-90	5860-301-90	5860-301-90	5860-301-90	1	
23,24,25	Flange Kit	5860-080-95	5860-080-97	5860-080-95	5860-080-97	5860-080-95	5860-080-97	5860-080-95	5860-080-97	5860-080-95	5860-080-97	5860-080-95	5860-080-97	1	



American Machine & Tool Co., Inc. of PA
(herein "AMT")
400 Spring Street
Royersford, PA 19468
Phone: (610) 948-3800
Fax: (610) 948-5300
www.amtpump.com



General Information

SALES POLICY: AMT products are sold through our established Distributors. We do not sell direct to the consumer or organization not entitled to trade recognition. Therefore, possession of our catalogs and/or price list(s) does not infer an offer to sell.

MINIMUM ORDER: We appreciate your order, however, all orders are subject to a minimum \$35.00 net invoice charge (excluding freight). This applies to all pump and parts purchase orders.

PRICES: Prices are subject to change without notice. All orders accepted are subject to prices in effect at time of shipment.

PAYMENT TERMS: Terms, upon establishment of credit, are Net 30 days. Past due accounts may be subject to a service charge of 1.5% per month. Domestic or assignable letter of credit is required for all export trade.

PAST DUE ACCOUNTS: AMT reserves the right to withhold open account shipments on any past due account. Invoices are considered past due after thirty (30) days. In the interest of sound business, all orders are subject to approval of the Credit Department.

SHIPPING INSTRUCTIONS: All shipments will be made F.O.B. the factory. Where instructions for shipment do not appear on the order, the shipment will be made according to our best judgment. Full risk of loss (including transportation delays and losses) shall pass to the customer upon delivery of the products to the carrier at the F.O.B. point. When loss or delay occurs, primary responsibility for tracing rests with the customer. When there is LOSS or APPARENT VISIBLE DAMAGE to a shipment, when tendered for delivery, **DO NOT** give the carrier a clear receipt. Note such damage on the carrier's delivery receipt and **HAVE THE DRIVER SIGN THE RECEIPT.**

PRODUCT REVISIONS: AMT reserves the right to discontinue, change or improve its products or any portions thereof without being obligated to provide such a change or improvement for units sold and/or shipped prior to such a change or improvement.

12 Month Limited Warranty

EXTENT AND DURATION OF LIMITED WARRANTY

Coverage: American Machine & Tool Company (herein "AMT") or IPT Pumps by Gorman-Rupp (herein "IPT") or Gorman-Rupp Industries Division of The Gorman-Rupp Company, Patterson, or the Gorman-Rupp Company (herein referred to as "G-R Unit") each individually warrants that its products and parts shall be free from defects in material and workmanship for twelve (12) months from the date of purchase by the original end user when installation is made and maintenance is performed in accordance with G-R Unit's recommendations. Wear and tear resulting from use and items normally consumed in use are not covered.

EXCEPTIONS

(A) This Limited Warranty shall not apply to mechanical seals in AMT or IPT pumps and the following products and parts: engines, motors, trade accessories and all other products, components, parts and materials not manufactured by the G-R Units. These items may, however, be covered by the warranties of their respective manufacturers. (B) This warranty does not extend to or apply to any unit which has been repaired or altered at any place other than by a G-R Unit, or by persons not expressly approved by a G-R Unit to make repairs or alterations, nor to any unit the serial number, model number or identification of which has been removed, defaced or altered. (C) This warranty does not extend to any product manufactured by a G-R Unit, which has been subjected to mis-use, neglect, accident, improper installation, or use in violation of instructions furnished by a G-R Unit. (D) Pump Kits: This warranty does not extend to any product sold by a G-R Unit unassembled as a Pump Kit. Pump Kits are warranted against defects in material and workmanship for 60 days from the date of shipment from a G-R Unit. Any Pump Kit parts deemed defective by a G-R Unit will be replaced free of charge within 60 days of shipment. Pump Kits are not returnable for credit.

LIMITATIONS

THE G-R UNITS' SOLE AND EXCLUSIVE WARRANTY WITH RESPECT TO THEIR PRODUCTS AND PARTS IS THIS LIMITED WARRANTY. THIS LIMITED WARRANTY IS IN LIEU OF ALL OTHER EXPRESS AND/OR IMPLIED WARRANTIES, INCLUDING IMPLIED WARRANTIES OF MERCHANTABILITY AND FITNESS FOR PARTICULAR PURPOSE.

EXCLUSIVE REMEDY AND DAMAGES

The sole and exclusive remedy for breach of this Warranty by a G-R Unit and the entire extent of its liability for such breach or for damages arising from the use of the products and parts covered under this Limited Warranty, shall be as follows:

LEAD TIME: Products designated "Quick Ship Product", also referred to as "QSP" will normally be shipped within 24 hours of receipt of a non-cancellable purchase order. Only limited quantities of "QSP" pumps are available.

STANDARD LEAD TIME: Lead time is two weeks for all non "QSP" product. AMT reserves the right to revise lead times as required due to availability of materials and all other causes beyond our control.

VIP SHIPMENT: Select AMT and IPT branded pumps are available for next day shipment for non-QSP (Quick Ship Products) items and subjected to a specific model surcharge per unit noted in the respective price book. Requires calling for availability, confirmation and a non-cancellable purchase order or credit card payment prior to shipment. The expedited shipping charges are an additional cost added separately from the VIP charges per item. AMT reserves the right to revise lead times as required due to availability of materials and all other causes beyond our control. QSP quantities are limited as determined by AMT.

ALL purchase orders must be submitted via hard copy sent to AMT customer service department by fax, EDI or e-mail.

RETURN GOODS POLICY: Goods shall not be returned without a return goods authorization number (RGA) issued by AMT customer service. The RGA number must be listed on the packing list. Only current model and part numbers with a valid date code may be returned (within one year from date of purchase). **A 20% restocking and packaging charge will apply to all returns. All shipping charges must be pre-paid. No exceptions.**

ORDER CHANGES BY CUSTOMER: Orders in process may not be changed except with written consent and may be subject to special charges.

- 1. Repair or Replacement:** If inspection shows that any G-R Unit product or part covered under this Limited Warranty is defective in materials or workmanship, the G-R Unit shall repair or replace the defective or non-conforming product or part without charge, whichever the G-R Unit chooses. You must have properly maintained and used the product or part claimed to be defective in accordance with the maintenance schedule or manual, which comes with the product. No allowance will be made for labor, installation, removal, transportation or other charges incurred by you in connection with such repair or replacement.
- 2. To obtain the above remedy:**
 - A.** Immediately notify the G-R Unit upon discovery of the claimed defect in materials or workmanship and provide the serial number or date code of the product and/or part(s) or provide the G-R Unit with the invoice or bill of sale referencing the product by no later than the expiration date of the warranty period.
 - B.** The G-R Unit will advise whether inspection will be necessary and how whether repair or replacement will be made. If inspection by the G-R Unit is necessary, the pump or defective part must be sent freight pre-paid to the G-R Unit. Return shipment will be F.O.B. the G-R Unit's plant.
 - C. Return Goods Authorization Requirement:** No product will be accepted for return or replacement without the prior written authorization of the G-R Unit. Upon such authorization, and in accordance with instructions from the G-R Unit, the product will be returned to the G-R Unit, shipping charges prepaid by the Buyer.
- 3. Damages:** The G-R Unit's liability for damages for breach of this Limited Warranty shall not exceed the amount of the purchase price of the product or part(s) in respect to which Such damages are claimed. **IN NO EVENT SHALL THE G-R UNITS BE LIABLE FOR INCIDENTAL, CONSEQUENTIAL OR SPECIAL DAMAGES FOR BREACH OF THIS LIMITED WARRANTY.**

Some states do not allow the exclusion or limitation of incidental or consequential damages, so the above limitation or exclusion may not apply to you. This Limited Warranty gives you specific legal rights, and you may also have other rights, which vary from state to state.



A Gorman-Rupp Company



BY
GORMAN-RUPP®

www.amtpump.com