

SFC

S & M Group
Stainless Fitted
Cast Iron
In-Line Pumps

*Bombas de
extremo de
succión de acero
inoxidable y
hierro fundido
Grupo S & M*

A Full Range of Product Features, *Una gama completa de características del producto*

Superior Materials of

Construction: AISI Type 316L stainless steel impellers with rugged cast iron casings and seal housings provide reliable performance. Pump sizes 22 through 28 have cast iron impellers.

Close-Coupled Design:

Compact design saves space and simplifies maintenance.

Back Pull-Out Design:

Simplifies maintenance.

In-Line Piping: Simplifies piping layout and connection.

Casing Drain: Convenient drain plug on suction for maintenance.

Applications: Hot and cold water circulation; water transfer; pressure boosting; OEM packages.

Mechanical Seal: Standard John Crane Type 21 mechanical seal.

Drive Motors: Standard NEMA design JP motors in single or three phase.

Suction and Discharge

Flanges: Mate with ANSI class 125/150 flanges.

Seal Vent: Easy twist open vent for air release during start-up.

Gauge Tops: Located on suction and discharge flanges for gauge mounting without pipe tops.

Materiales superiores de

construcción: Los impulsores de acero inoxidable AISI tipo 316L con carcasas de hierro fundido y cajas para sello resistentes ofrecen un rendimiento confiable.

Diseño de acoplamiento

compacto: El diseño compacto ahorra espacio y simplifica el mantenimiento.

Diseño de extracción trasera:

Simplifica el mantenimiento cuando se usa con el acoplamiento tipo espaciador.

Tubería en línea: Simplifica la distribución y conexión de las tuberías.

Drenaje de la carcasa:

Conveniente tapón de drenaje en la succión para realizar actividades de mantenimiento.

Aplicaciones: Circulación de agua caliente y fría; transferencia de agua, elevación de presión; paquetes OEM (fabricantes de equipo original).

Sello mecánico: Sello mecánico estándar John Crane Tipo 21.

Motores de accionamiento:

Motores JP de diseño NEMA estándar monofásicos o trifásicos.

Bridas de succión y

descarga: Acoplan con bridas ANSI clase 125/150.

Orificio de ventilación de

sello: Orificio de ventilación fácil de abrir girándolo para liberar el aire durante la puesta en marcha.

Cabezales para indicadores:

Situadas sobre las bridas de succión y de descarga para el montaje de indicadores sin cabezales de tuberías.

Performance Coverage, 3500 and 1750 RPM
Alcance de funcionamiento, 3500 y 1750 RPM

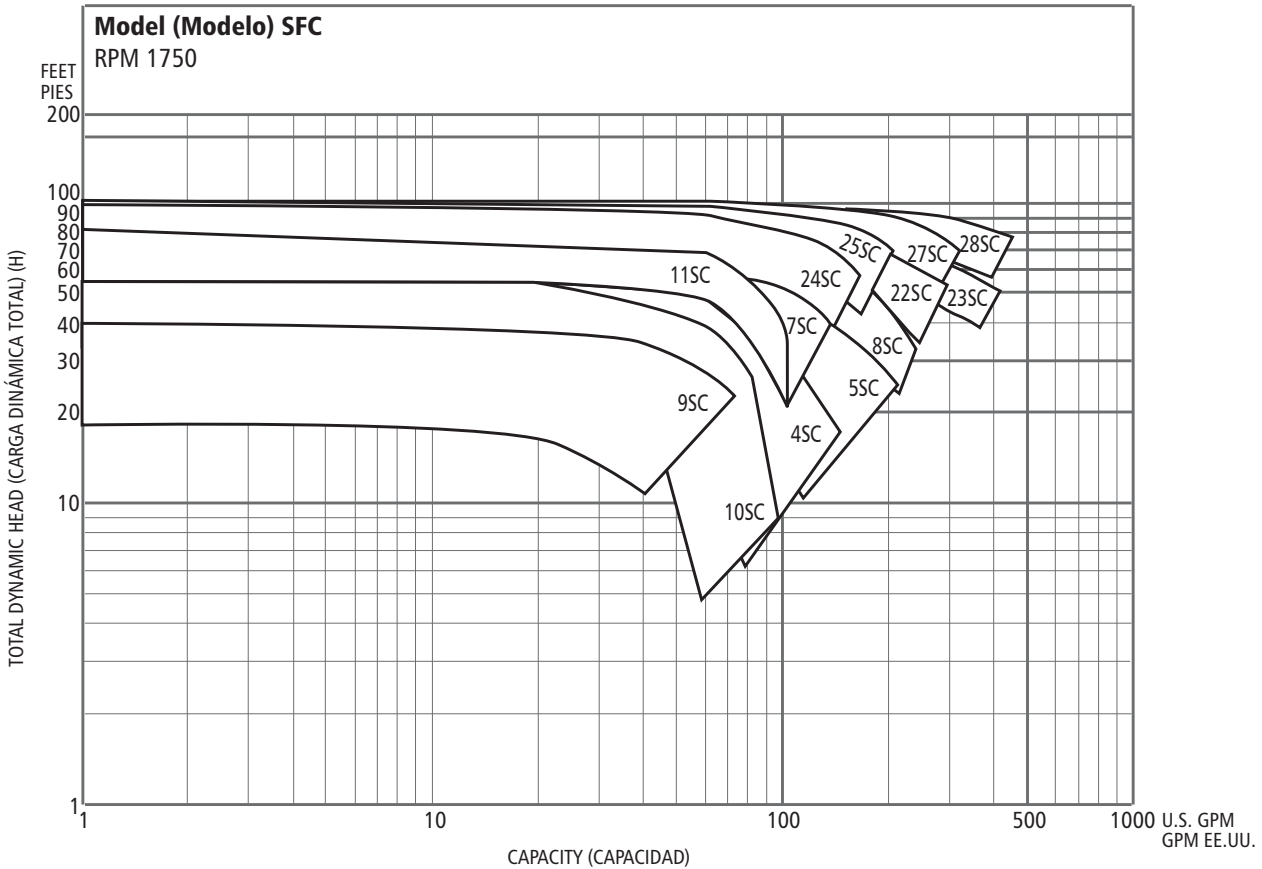
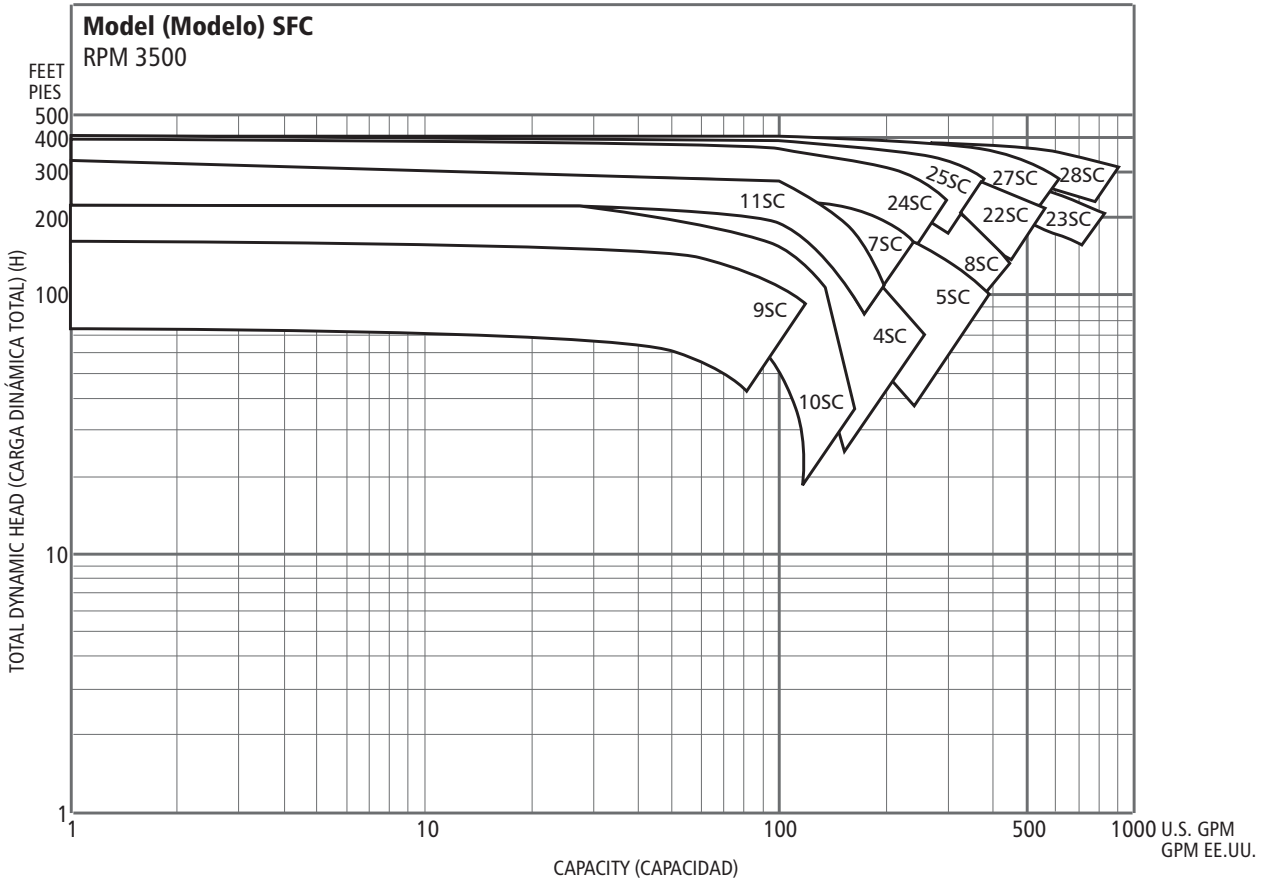

SFC Numbering System

Sistema de numeración del grupo SFC

Example Product Code, Ejemplo código del producto

4 SC 1 L 3 A 0

Mechanical Seal and O-Ring

0 = Standard

For optional Mechanical Seal modify catalog order no. with Seal Code listed below.

Sello mecánico y anillo-0

0 = Estándar

Para sello mecánico opcional modificar el número de orden del catálogo con el código del sello que se presenta abajo.

John Crane Type 21 Mechanical Seal, Sello mecánico John Crane tipo 21

Seal Code, Código del Sello	Rotary, Rotativo	Stationary, Estacionario	Elastomers, Elastómeros	Metal Parts, Partes metálicas	Part No., Pieza número	
					S-Group, Grupo S	M-Group, Grupo M
0	Carbon, Carbón	Ceramic, Cerámica	BUNA	316 SS, Acero inoxidable 316	10K13	10K16
2		Sil-Carbide, Carburo de silicio	EPR		10K19	10K20
4		Sil-Carbide	Viton		10K27	10K45
5	10K64				10K65	

Impeller Option Code . . . No Adder Required

For optional impeller diameters modify catalog no. with impeller code listed below.

Select optional impeller diameter from pump performance curve.

Código de opción del impulsor . . . No se requiere agregado

Para diámetros opcionales de impulsor modificar el número de orden del catálogo con el código del impulsor enumerado abajo.

Seleccionar el diámetro del impulsor de la curva característica de la bomba.

Impeller Code, Código del impulsor	Diameter, Diámetro												
	9SC 1½ x 1½-6	10SC 1½ x 1½-8	11SC 1½ x 1½-10	4SC 2 x 2-6	7SC 2 x 2-8	5SC 2½ x 2½-6	8SC 2½ x 2½-8	24SC 2 x 2-10	25SC 2½ x 2½-10	22SC 3 x 3-8	27SC 3 x 3-10	23SC 4 x 4-8	28SC 4 x 4-10
A	6⅞	8⅞	10⅞	6¾	8¼	6⅞	8¼	9⅞	9⅞	8½	9¾	8⅞	9⅞
B	6⅞	7⅞	9⅞	6⅞	7⅞	6⅞	7¾	9½	9½	8⅞	9⅞	8¼	9⅞
C	5⅞	7⅞	9⅞	6⅞	7	5⅞	7½	9⅞	9⅞	8⅞	9⅞	8	8⅞
D	5⅞	7⅞	8¾	5⅞	6¾	5½	7⅞	8⅞	8⅞	7⅞	8⅞	7⅞	8⅞
E	4¾	6⅞		5⅞	6⅞	5½	6⅞	8⅞	8⅞	7½	8⅞	7¼	8¼
F	4¾	6⅞		4⅞	6⅞	4⅞		8¼	7⅞				
G				4⅞		4⅞				6¾			

Driver, Fuerza motriz

1 = 1 PH, fase, ODP 6 = 575 V, TEFC

2 = 3 PH, fases, ODP 7 = 3 PH, fases, XP

3 = 575 V, ODP 8 = 575 V, XP

4 = 1 PH, fase, TEFC 9 = 3 PH, fases, TEFC (1.25 S.F., Factor de servicio de 1.25)

5 = 3 PH, fases, TEFC 0 = 1 PH, fase, XP

HP Rating, Clasificación de potencia

C = ½ HP

G = 2 HP

L = 10 HP

Q = 30 HP

U = 75 HP

D = ¾ HP

H = 3 HP

M = 15 HP

R = 40 HP

V = 100 HP

E = 1 HP

J = 5 HP

N = 20 HP

S = 50 HP

F = 1½ HP

K = 7½ HP

P = 25 HP

T = 60 HP

Driver: Hertz/Pole/RPM, Motor: hertzios/polo/RPM

1 = 60 Hz, 2 pole (polos), 3500 RPM

2 = 60 Hz, 4 pole (polos), 1750 RPM

3 = 60 Hz, 6 pole (polos), 1150 RPM

4 = 50 Hz, 2 pole (polos), 2900 RPM

5 = 50 Hz, 4 pole (polos), 1450 RPM

Material

SC = 316L Stainless steel and cast iron, Acero inoxidable 316L y hierro fundido

Pump Size, Tamaño de la bomba

9 = 1½ x 1½ - 6

4 = 2 x 2 - 6

8 = 2½ x 2½ - 8

22 = 3 x 3 - 8

28 = 4 x 4 - 10

10 = 1½ x 1½ - 8

7 = 2 x 2 - 8

24 = 2 x 2 - 10

27 = 3 x 3 - 10

11 = 1½ x 1½ - 10

5 = 2½ x 2½ - 6

25 = 2½ x 2½ - 10

23 = 4 x 4 - 8

Performance Curves – S-Group, 60 Hz, 3500 RPM
Curvas de funcionamiento – Grupo S, 60 Hz, 3500 RPM

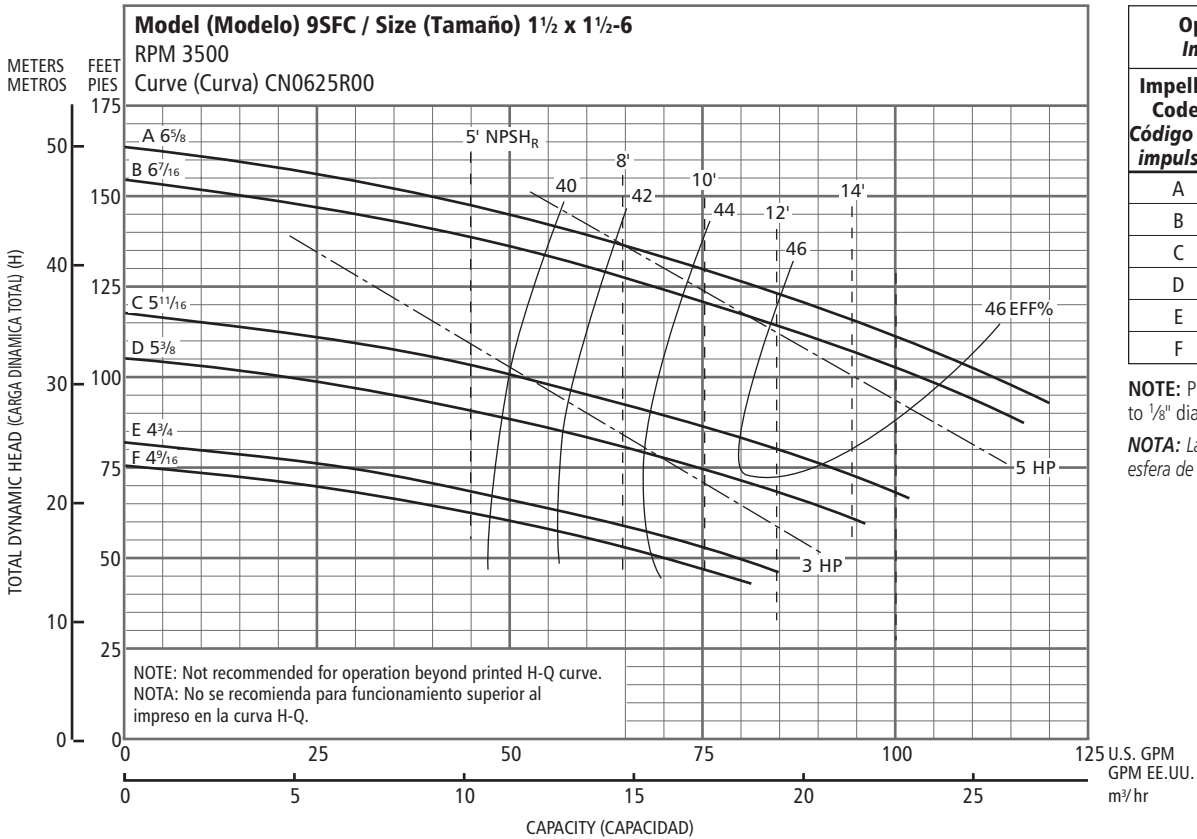

Optional Impeller, Impulsor opcional		
Impeller Code, Código del impulsor	Dia., Diám.	Motor HP, HP del motor
A	6 ⁵ / ₈ "	7½
B	6 ⁷ / ₁₆ "	5
C	5 ¹¹ / ₁₆ "	5
D	5 ³ / ₈ "	3
E	4 ³ / ₄ "	2
F	4 ⁹ / ₁₆ "	2

NOTE: Pump will pass a sphere to 1/8" diameter.
 NOTA: La bomba pasará una esfera de 1/8" de diámetro máximo.

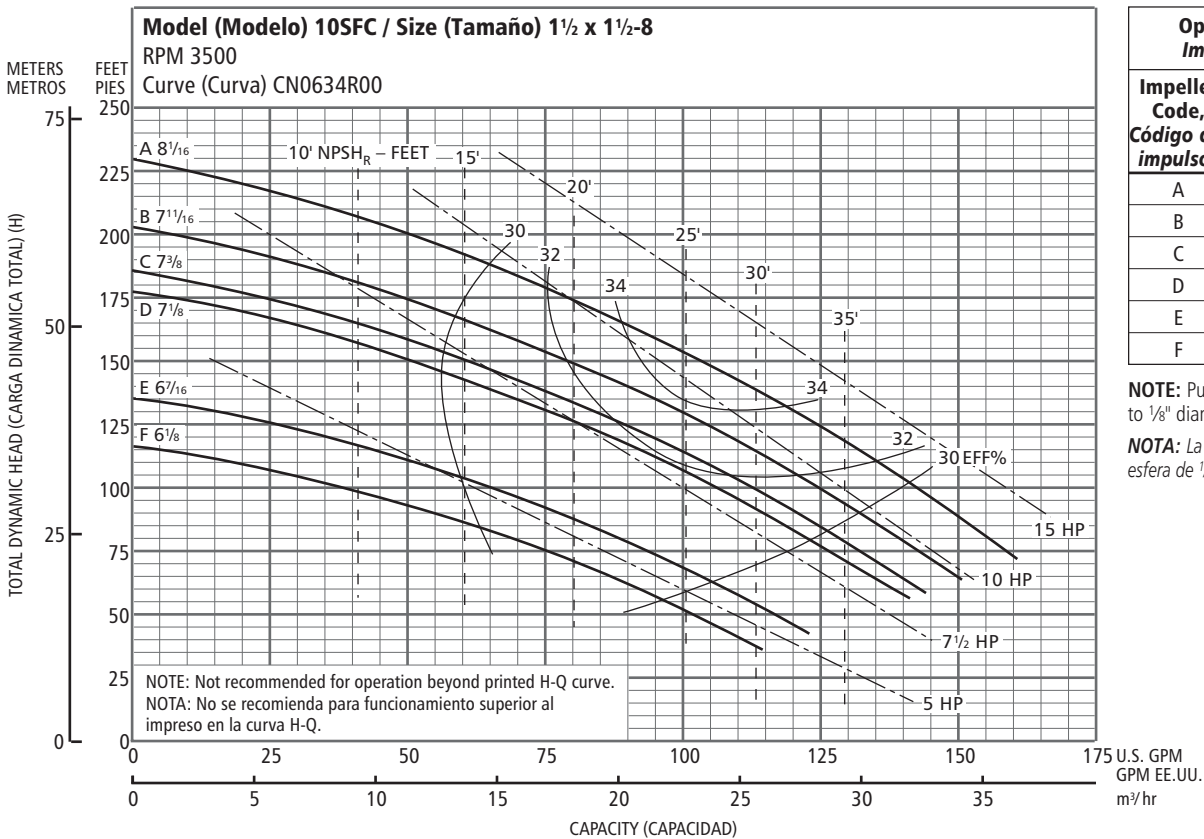

Optional Impeller, Impulsor opcional		
Impeller Code, Código del impulsor	Dia., Diám.	Motor HP, HP del motor
A	8 ¹ / ₁₆ "	15
B	7 ¹¹ / ₁₆ "	10
C	7 ³ / ₈ "	10
D	7 ¹ / ₈ "	7½
E	6 ⁷ / ₁₆ "	5
F	6 ¹ / ₈ "	5

NOTE: Pump will pass a sphere to 1/8" diameter.
 NOTA: La bomba pasará una esfera de 1/8" de diámetro máximo.

Performance Curves – S-Group, 60 Hz, 3500 RPM
Curvas de funcionamiento – Grupo S, 60 Hz, 3500 RPM

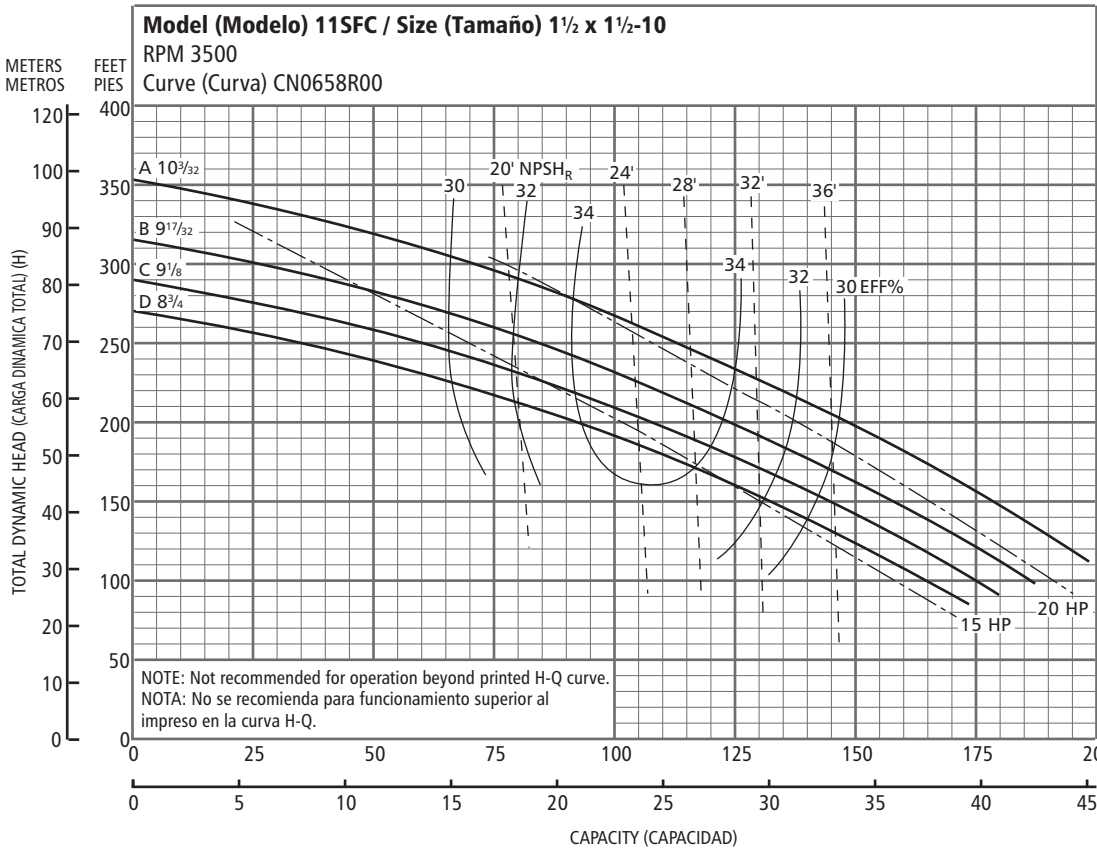

Optional Impeller, Impulsor opcional

Impeller Code, Código del impulsor	Dia., Diám.	Motor HP, HP del motor
A	10 ³ / ₃₂ "	20
B	9 ¹⁷ / ₃₂	20
C	9 ¹ / ₈	15
D	8 ³ / ₄	15

NOTE: Pump will pass a sphere to 1/8" diameter.
 NOTA: La bomba pasará una esfera de 1/8" de diámetro máximo.

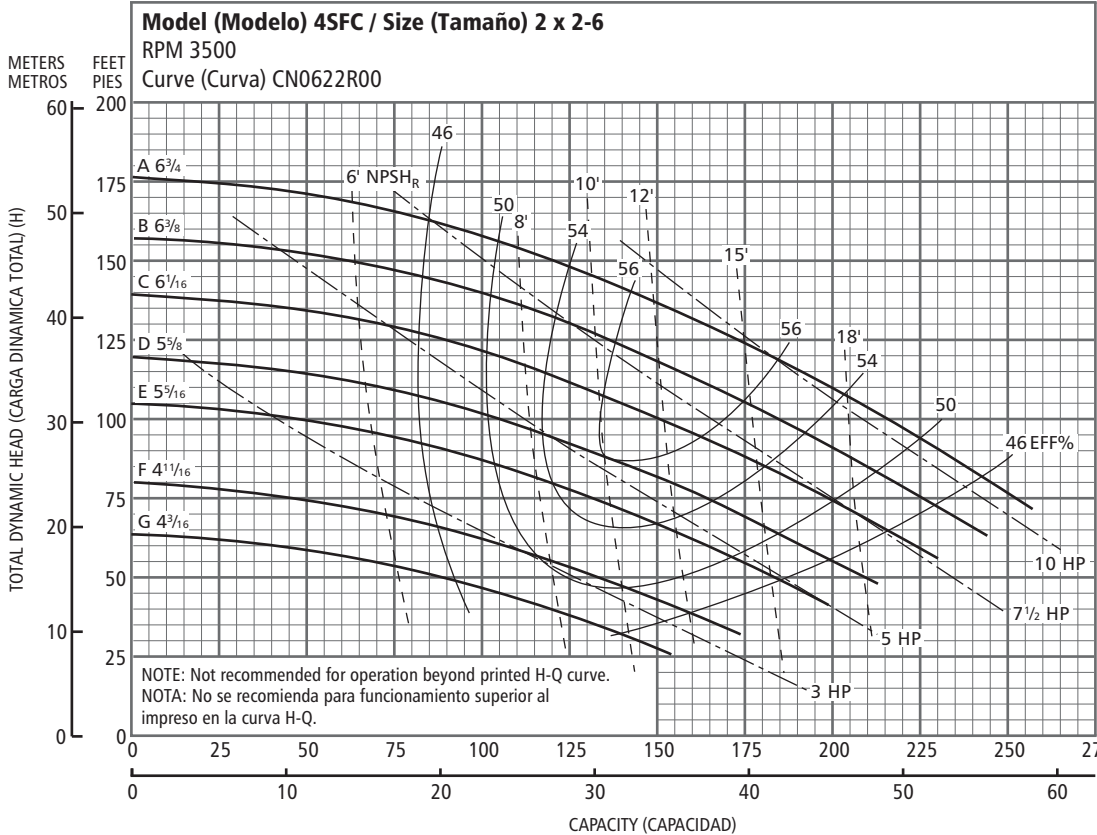

Optional Impeller, Impulsor opcional

Impeller Code, Código del impulsor	Dia., Diám.	Motor HP, HP del motor
A	6 ³ / ₄ "	10
B	6 ³ / ₈	10
C	6 ¹ / ₁₆	7½
D	5 ⁵ / ₈	7½
E	5 ⁵ / ₁₆	5
F	4 ¹¹ / ₁₆	3
G	4 ³ / ₁₆	3

NOTE: Pump will pass a sphere to 3/16" diameter.
 NOTA: La bomba pasará una esfera de 3/16" de diámetro máximo.

Performance Curves – S-Group, 60 Hz, 3500 RPM
Curvas de funcionamiento – Grupo S, 60 Hz, 3500 RPM

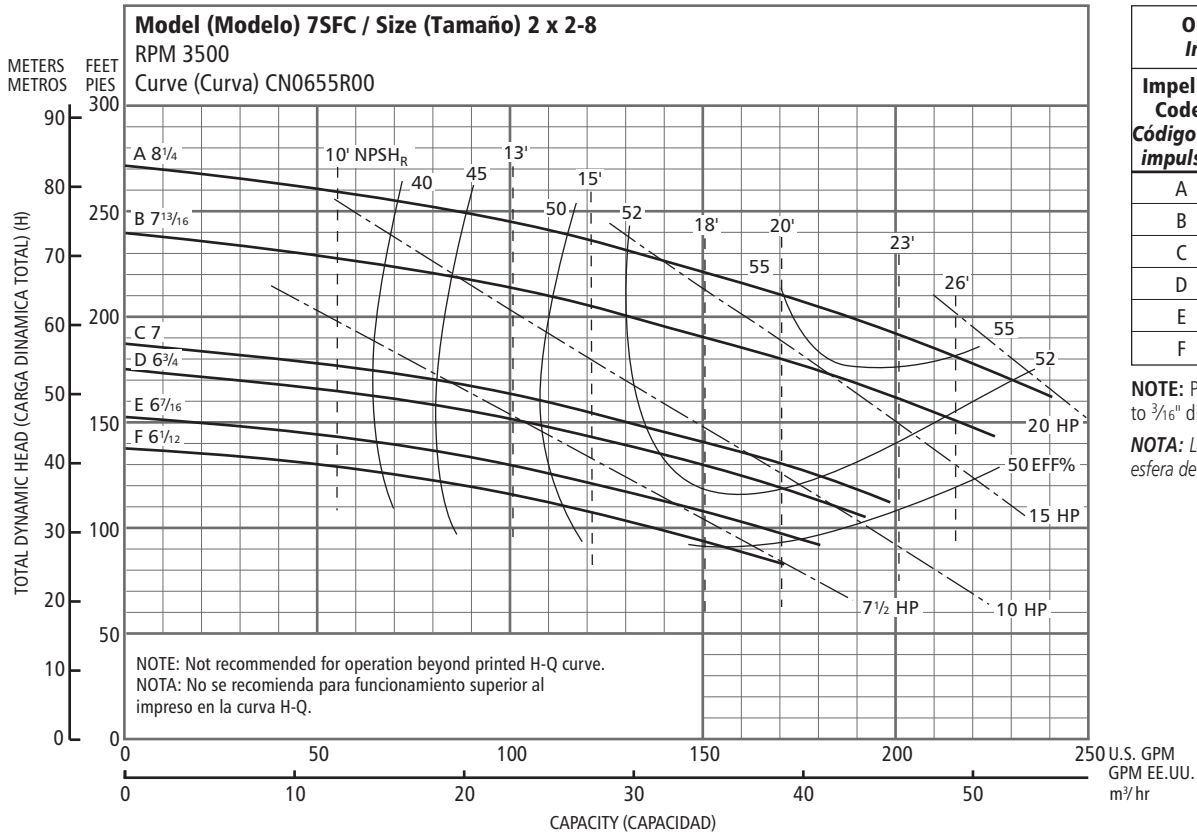

Optional Impeller, Impulsor opcional		
Impeller Code, Código del impulsor	Dia., Diám.	Motor HP, HP del motor
A	8 1/4"	20
B	7 13/16	15
C	7	10
D	6 3/4	10
E	6 7/16	7 1/2
F	6 1/2	7 1/2

NOTE: Pump will pass a sphere to 3/16" diameter.
 NOTA: La bomba pasará una esfera de 3/16" de diámetro máximo.

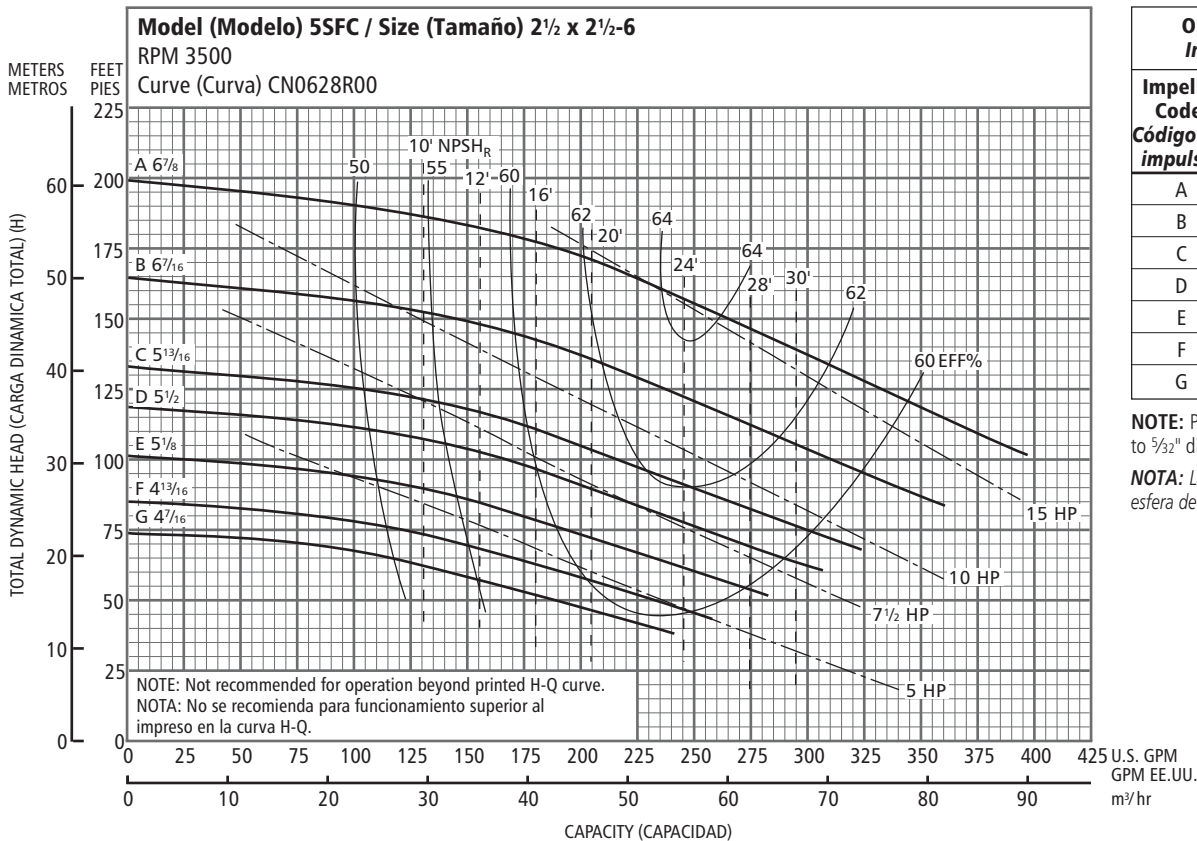

Optional Impeller, Impulsor opcional		
Impeller Code, Código del impulsor	Dia., Diám.	Motor HP, HP del motor
A	6 7/8"	15
B	6 7/16	15
C	5 13/16	10
D	5 1/2	10
E	5 1/8	7 1/2
F	4 13/16	5
G	4 7/16	5

NOTE: Pump will pass a sphere to 5/32" diameter.
 NOTA: La bomba pasará una esfera de 5/32" de diámetro máximo.

Performance Curves – M-Group, 60 Hz, 3500 RPM
Curvas de funcionamiento – Grupo M, 60 Hz, 3500 RPM

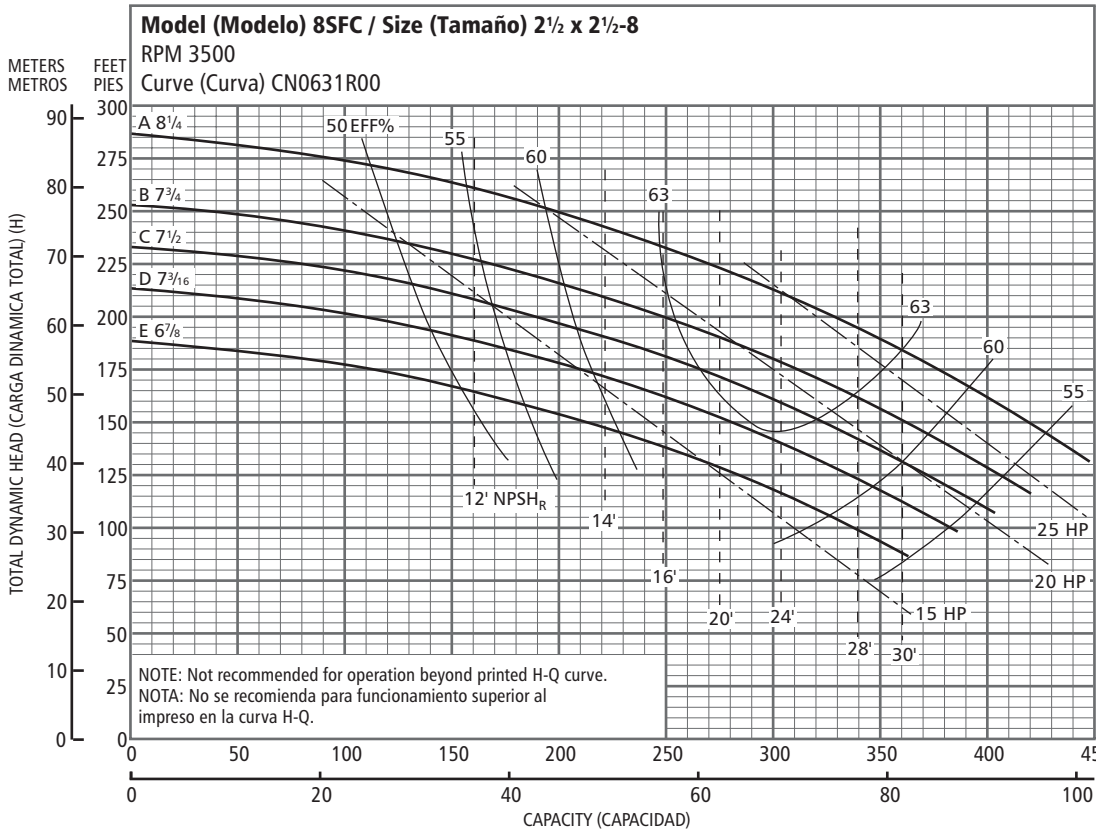

Optional Impeller, Impulsor opcional

Impeller Code, Código del impulsor	Dia., Diám.	Motor HP, HP del motor
A	8 1/4"	25
B	7 3/4"	25
C	7 1/2"	20
D	7 3/16"	20
E	6 7/8"	15

NOTE: Pump will pass a sphere to 5/32" diameter.
 NOTA: La bomba pasará una esfera de 5/32" de diámetro máximo.

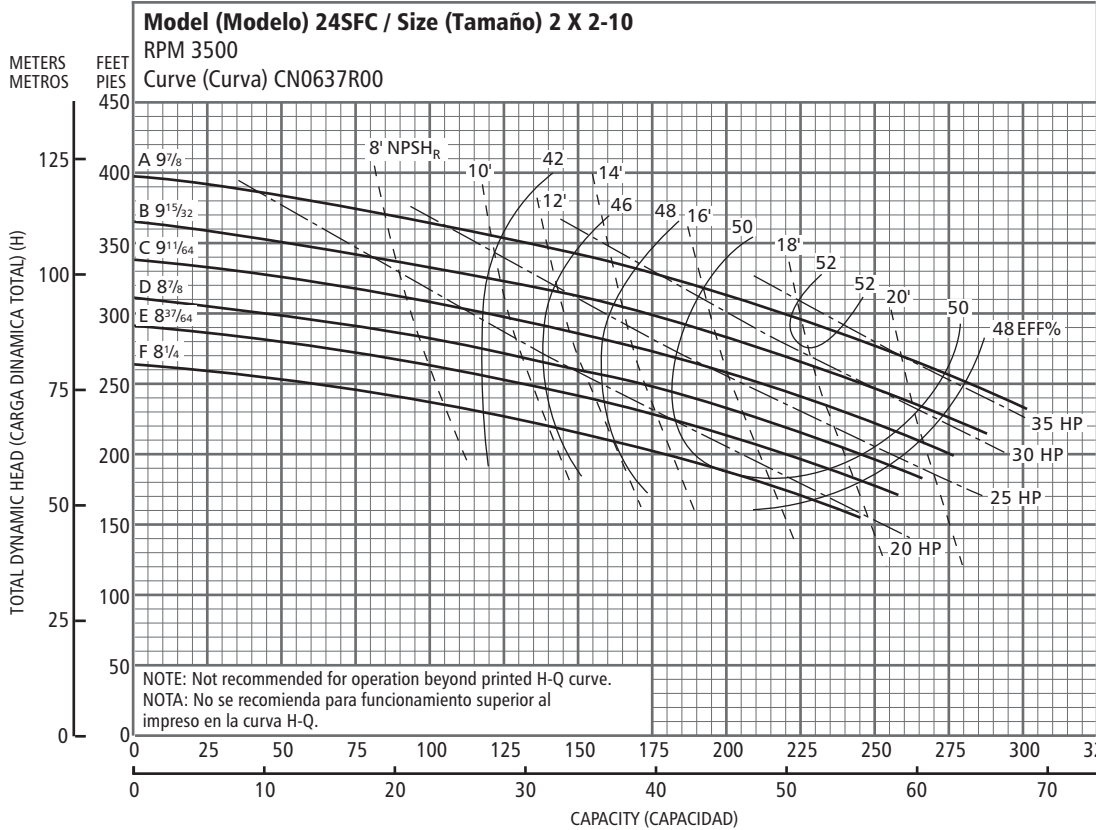

Optional Impeller, Impulsor opcional

Impeller Code, Código del impulsor	Dia., Diám.	Motor HP, HP del motor
A	9 7/8"	40
B	9 15/32"	30
C	9 1/64"	25
D	8 7/8"	25
E	8 37/64"	20
F	8 1/4"	20

NOTE: Pump will pass a sphere to 5/16" diameter.
 NOTA: La bomba pasará una esfera de 5/16" de diámetro máximo.

Performance Curves – M-Group, 60 Hz, 3500 RPM
Curvas de funcionamiento – Grupo M, 60 Hz, 3500 RPM

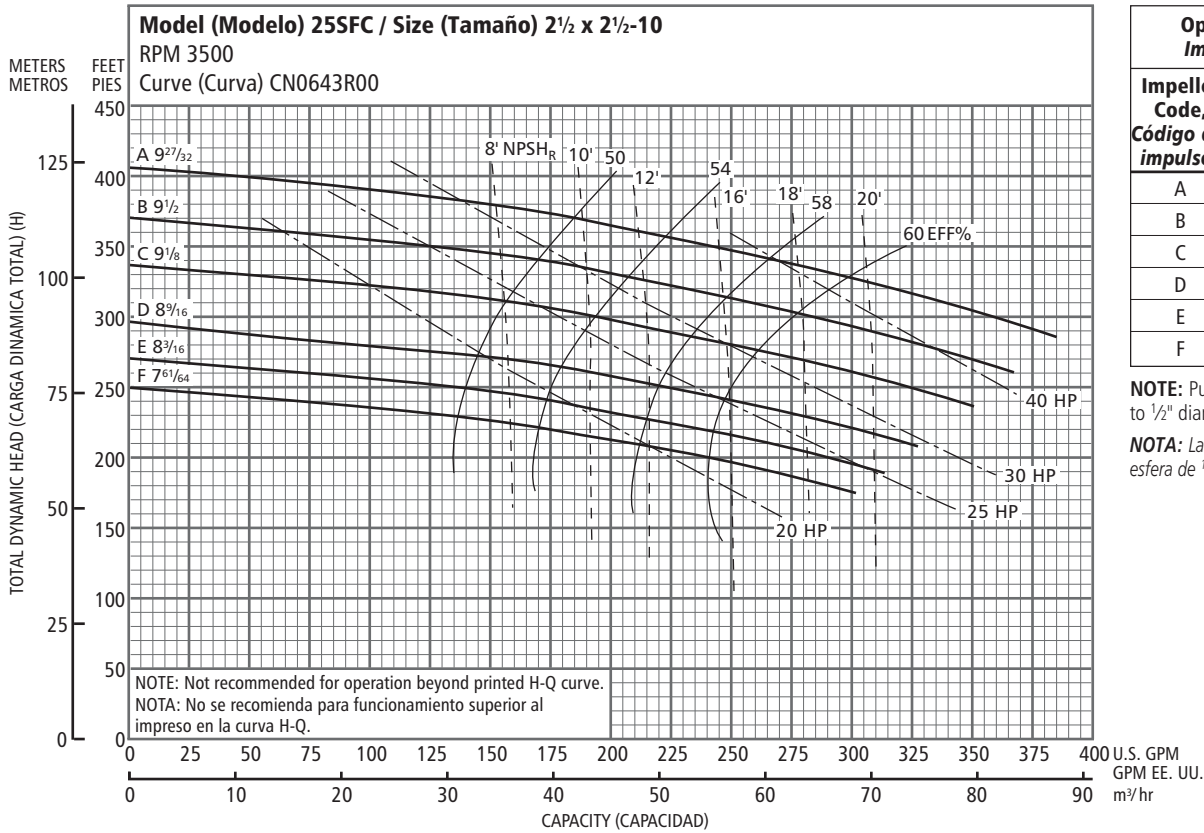

Optional Impeller, Impulsor opcional		
Impeller Code, Código del impulsor	Dia., Diám.	Motor HP, HP del motor
A	9 ²⁷ / ₃₂ "	40
B	9½"	40
C	9 ¹ / ₈ "	30
D	8 ⁹ / ₁₆ "	30
E	8 ³ / ₁₆ "	25
F	7 ⁶ / ₆₄ "	25

NOTE: Pump will pass a sphere to ½" diameter.
 NOTA: La bomba pasará una esfera de ½" de diámetro máximo.

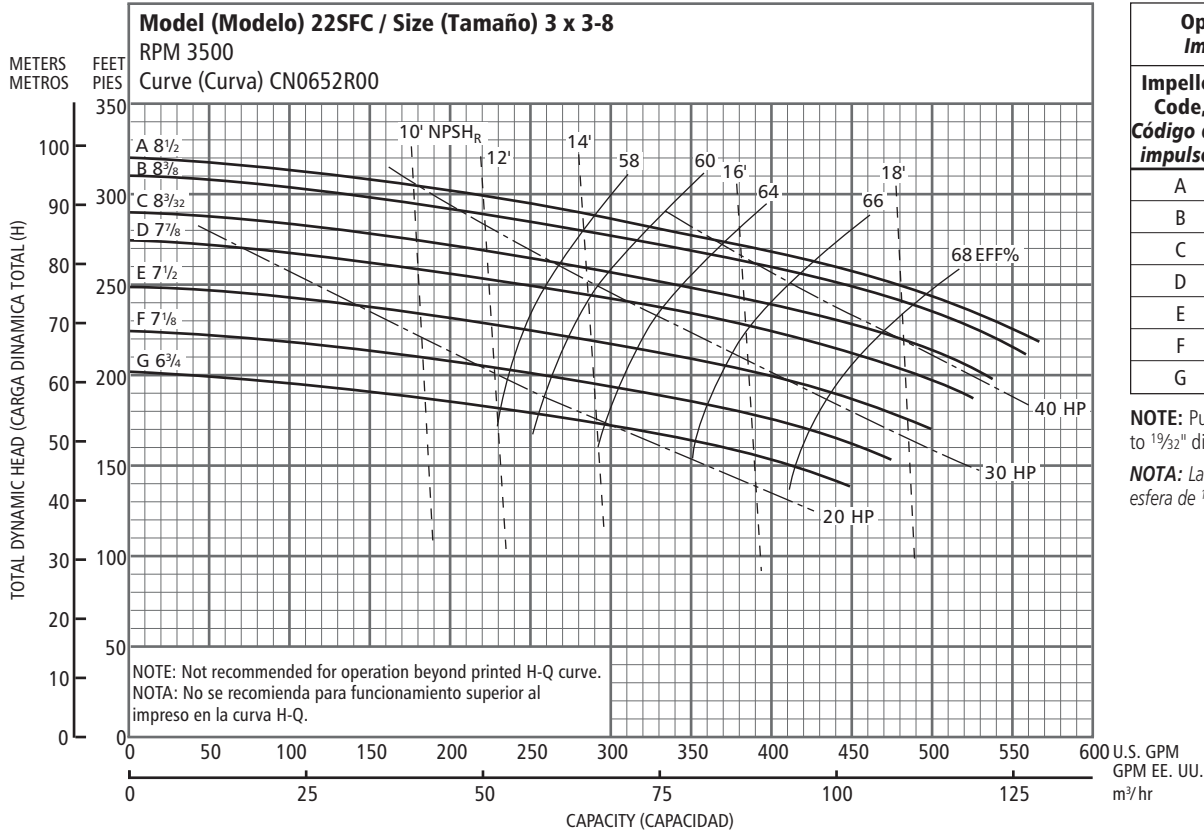

Optional Impeller, Impulsor opcional		
Impeller Code, Código del impulsor	Dia., Diám.	Motor HP, HP del motor
A	8½"	40
B	8 ³ / ₈ "	40
C	8 ³ / ₃₂ "	40
D	7 ⁷ / ₈ "	40
E	7½"	30
F	7 ¹ / ₈ "	25
G	6 ³ / ₄ "	25

NOTE: Pump will pass a sphere to 1⁹/₃₂" diameter.
 NOTA: La bomba pasará una esfera de 1⁹/₃₂" de diámetro máximo.

Performance Curves – M-Group, 60 Hz, 3500 RPM
Curvas de funcionamiento – Grupo M, 60 Hz, 3500 RPM

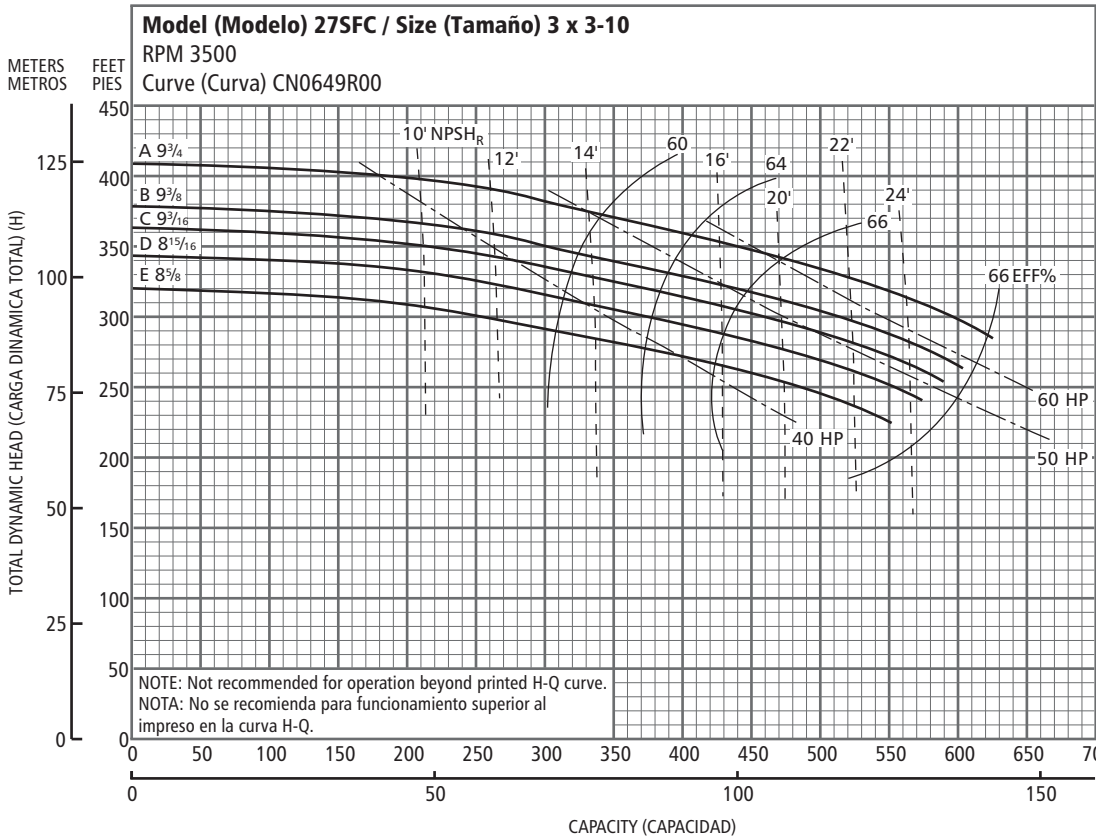

Optional Impeller, Impulsor opcional

Impeller Code, Código del impulsor	Dia., Diám.	Motor HP, HP del motor
A	9 ³ / ₄ "	60
B	9 ³ / ₈	60
C	9 ³ / ₁₆	50
D	8 ¹⁵ / ₁₆	50
E	8 ⁵ / ₈	50

NOTE: Pump will pass a sphere to 1⁹/₃₂" diameter.
 NOTA: La bomba pasará una esfera de 1⁹/₃₂" de diámetro máximo.

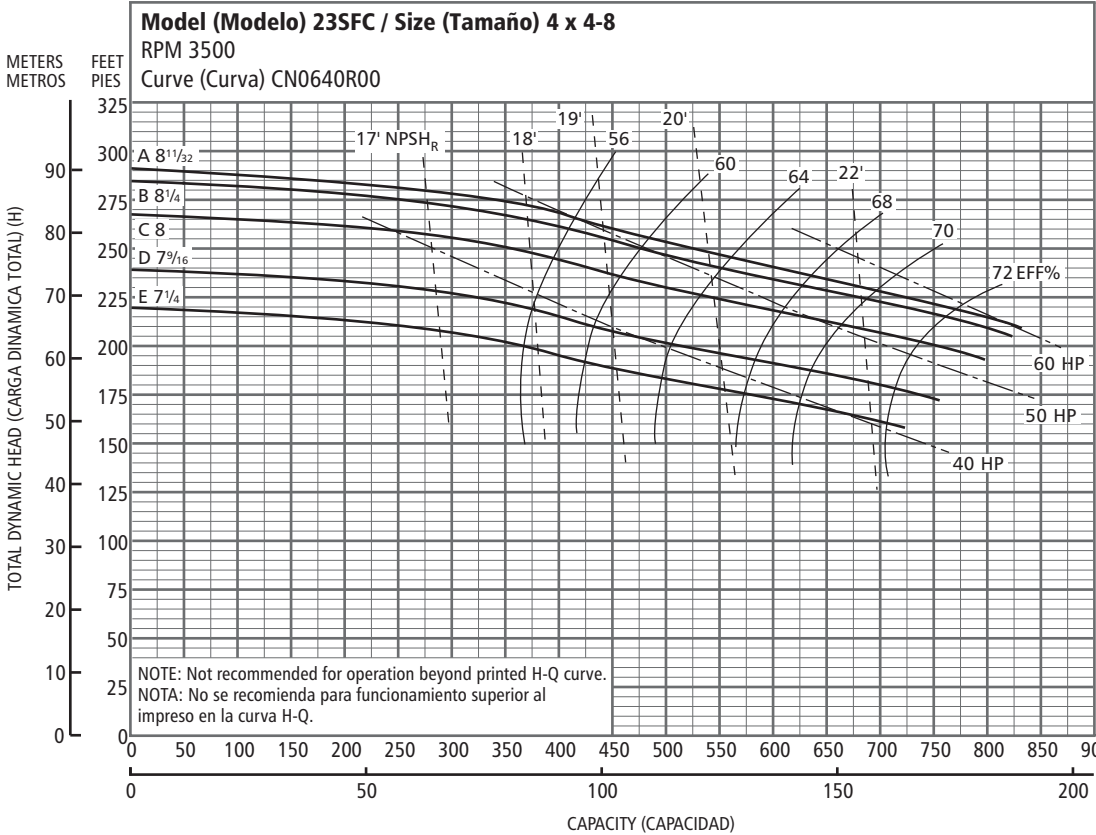

Optional Impeller, Impulsor opcional

Impeller Code, Código del impulsor	Dia., Diám.	Motor HP, HP del motor
A	8 ¹¹ / ₃₂ "	60
B	8 ¹ / ₄	60
C	8	50
D	7 ⁹ / ₁₆	40
E	7 ¹ / ₄	40

NOTE: Pump will pass a sphere to 3³/₄" diameter.
 NOTA: La bomba pasará una esfera de 3³/₄" de diámetro máximo.

Performance Curves – S-Group, 60 Hz, 3500 RPM
Curvas de funcionamiento – Grupo S, 60 Hz, 3500 RPM

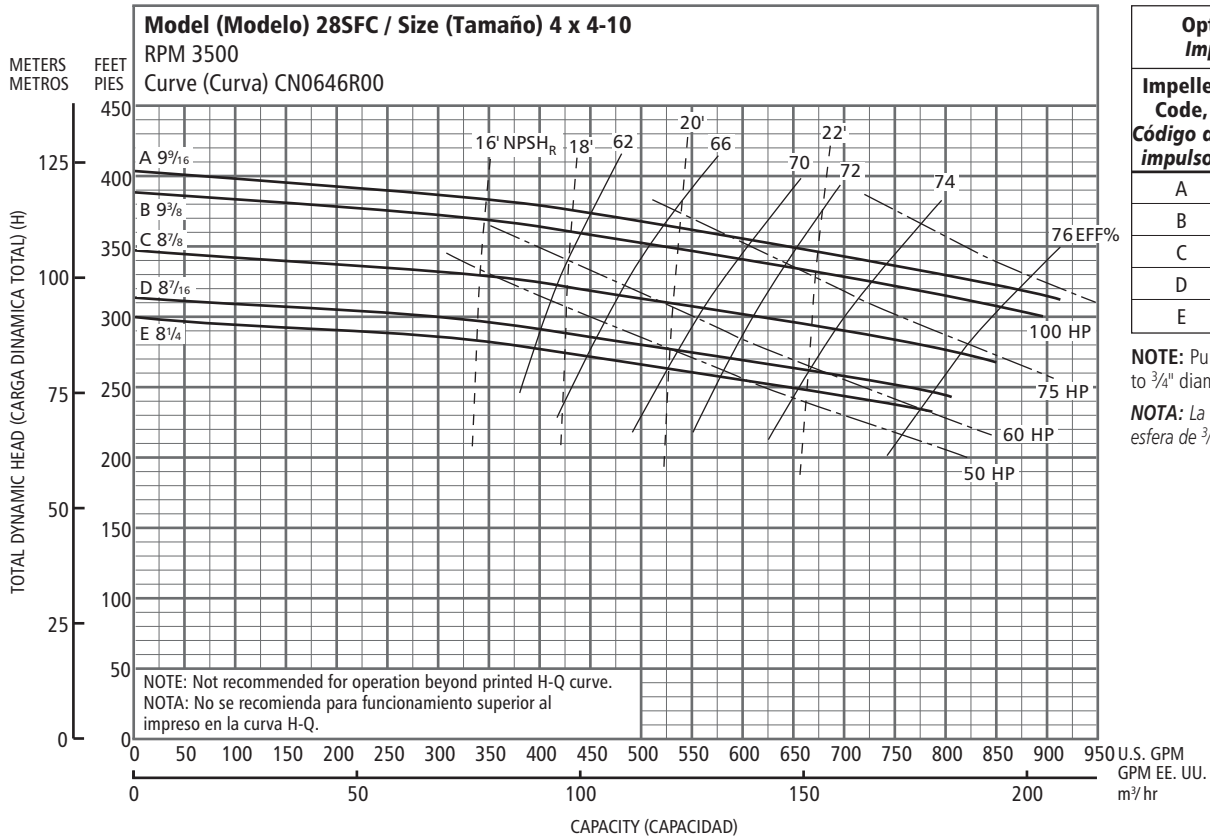

Optional Impeller, Impulsor opcional

Impeller Code, Código del impulsor	Dia., Diám.	Motor HP, HP del motor
A	9 ⁹ / ₁₆ "	100
B	9 ³ / ₈	100
C	8 ⁷ / ₈	75
D	8 ⁷ / ₁₆	60
E	8 ¹ / ₄	60

NOTE: Pump will pass a sphere to 3/4" diameter.
 NOTA: La bomba pasará una esfera de 3/4" de diámetro máximo.

Performance Curves – S-Group, 60 Hz, 1750 RPM
Curvas de funcionamiento – Grupo S, 60 Hz, 1750 RPM

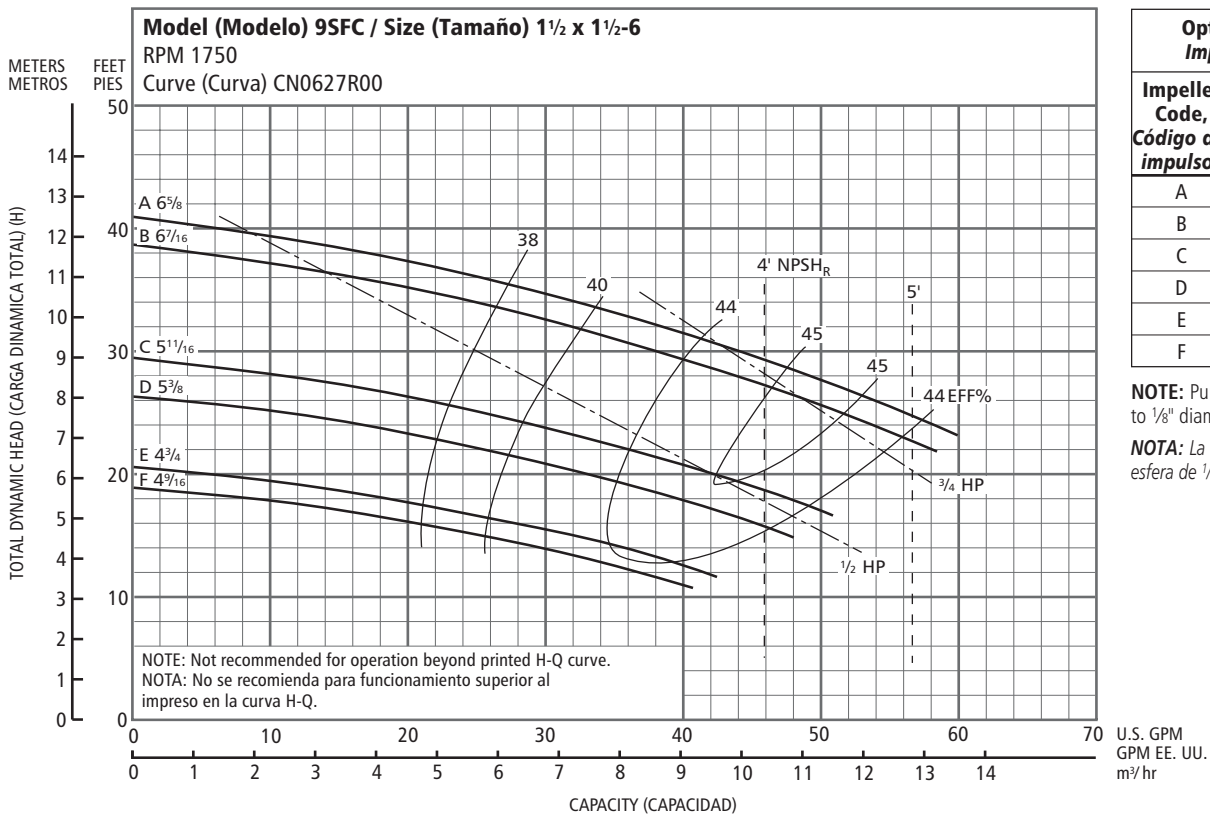

Optional Impeller, Impulsor opcional

Impeller Code, Código del impulsor	Dia., Diám.	Motor HP, HP del motor
A	6 ⁵ / ₈ "	3/4
B	6 ⁷ / ₁₆	3/4
C	5 ¹¹ / ₁₆	1/2
D	5 ³ / ₈	1/2
E	4 ³ / ₄	1/2
F	4 ⁹ / ₁₆	1/2

NOTE: Pump will pass a sphere to 1/8" diameter.
 NOTA: La bomba pasará una esfera de 1/8" de diámetro máximo.

Performance Curves – S-Group, 60 Hz, 1750 RPM
Curvas de funcionamiento – Grupo S, 60 Hz, 1750 RPM

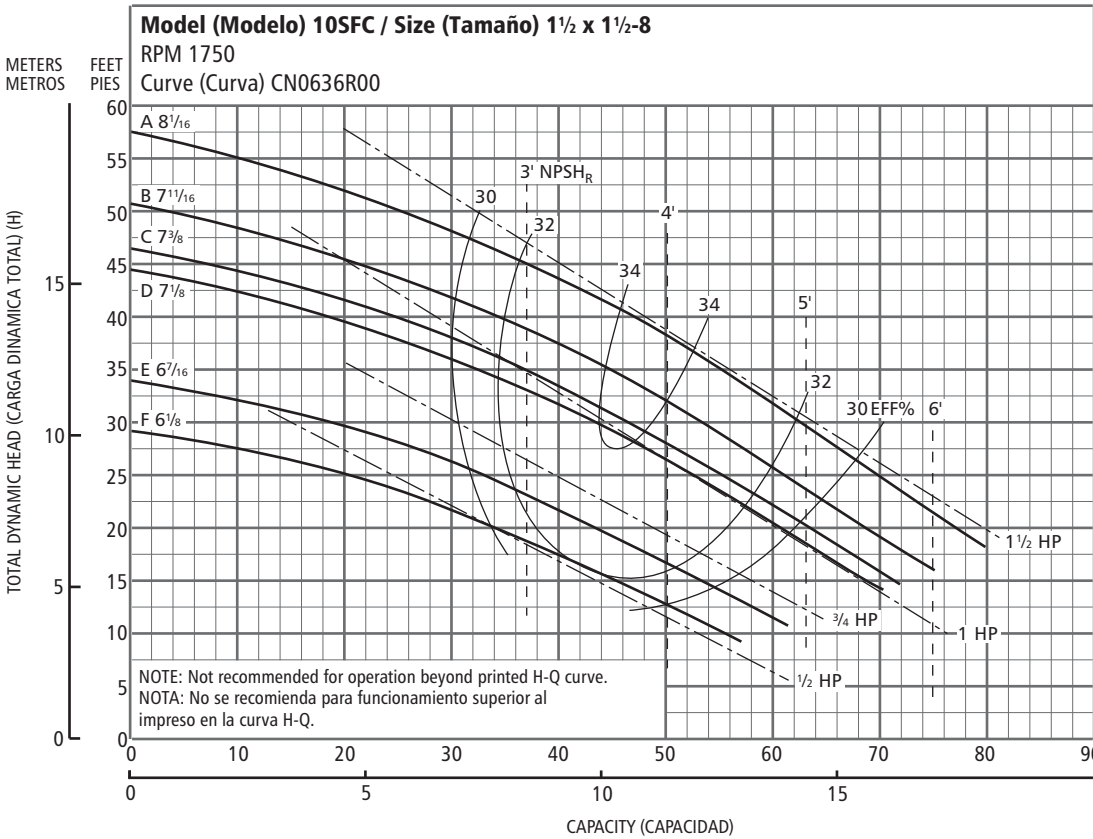

Optional Impeller, Impulsor opcional

Impeller Code, Código del impulsor	Dia., Diám.	Motor HP, HP del motor
A	8 ¹ / ₁₆ "	1½
B	7 ¹ / ₁₆ "	1½
C	7 ³ / ₈ "	1
D	7 ¹ / ₈ "	1
E	6 ⁷ / ₁₆ "	¾
F	6 ¹ / ₈ "	½

NOTE: Pump will pass a sphere to 1/8" diameter.
 NOTA: La bomba pasará una esfera de 1/8" de diámetro máximo.

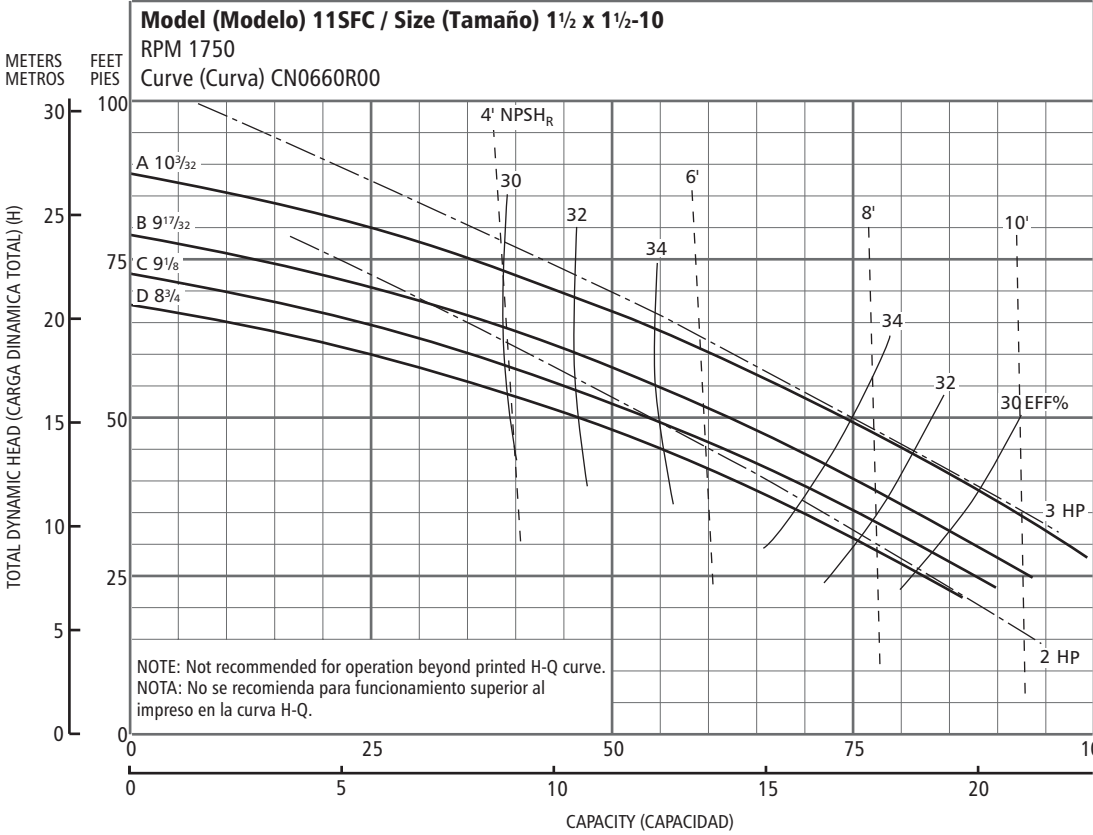

Optional Impeller, Impulsor opcional

Impeller Code, Código del impulsor	Dia., Diám.	Motor HP, HP del motor
A	10 ³ / ₃₂ "	3
B	9 ¹⁷ / ₃₂ "	3
C	9 ¹ / ₈ "	2
D	8 ³ / ₄ "	2

NOTE: Pump will pass a sphere to 1/8" diameter.
 NOTA: La bomba pasará una esfera de 1/8" de diámetro máximo.

Performance Curves – S-Group, 60 Hz, 1750 RPM
Curvas de funcionamiento – Grupo S, 60 Hz, 1750 RPM

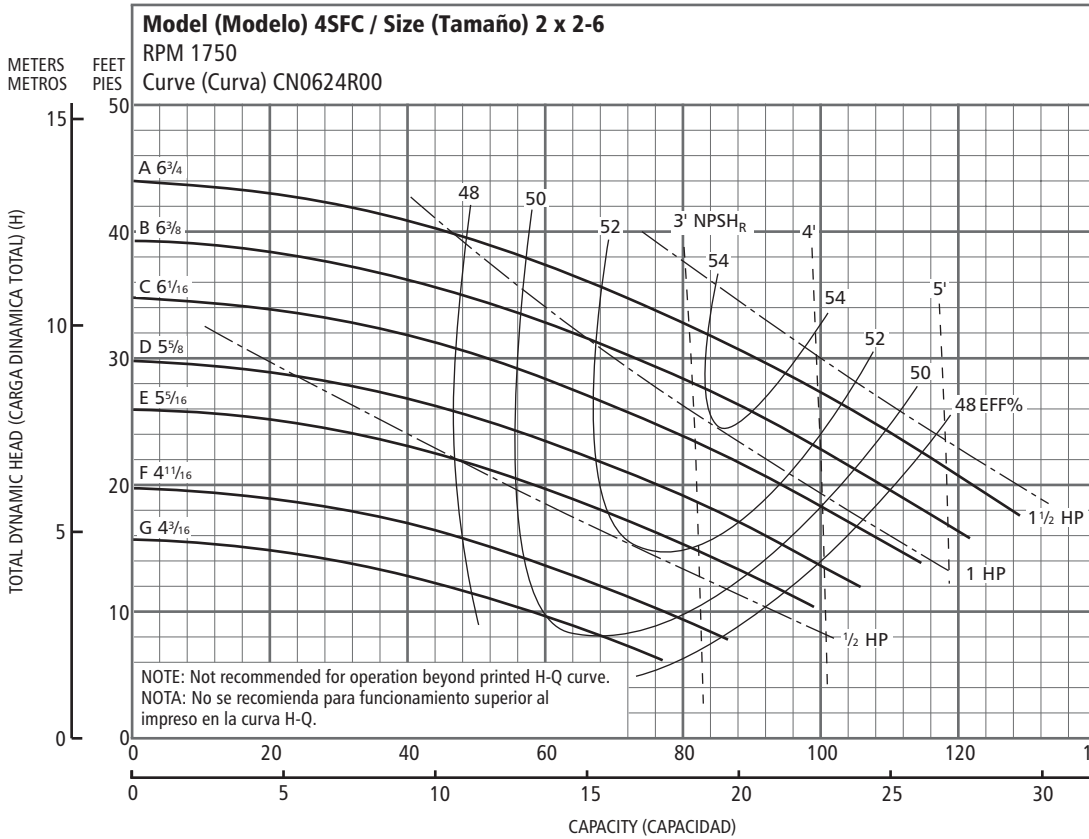

Optional Impeller, Impulsor opcional		
Impeller Code, Código del impulsor	Dia., Diám.	Motor HP, HP del motor
A	6 ³ / ₄ "	1 ¹ / ₂
B	6 ³ / ₈	1
C	6 ¹ / ₁₆	1
D	5 ⁵ / ₈	3/4
E	5 ⁵ / ₁₆	1/2
F	4 ¹¹ / ₁₆	1/2
G	4 ³ / ₁₆	1/2

NOTE: Pump will pass a sphere to ⁵/₃₂" diameter.
 NOTA: La bomba pasará una esfera de ⁵/₃₂" de diámetro máximo.

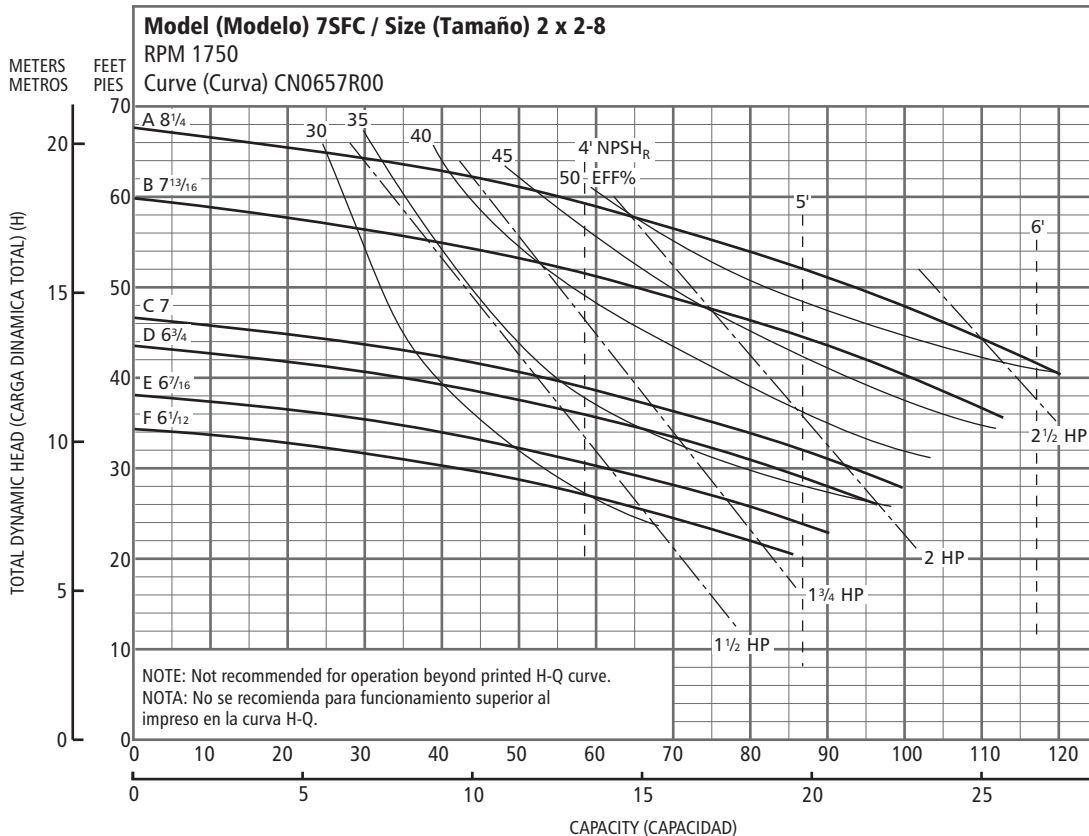

Optional Impeller, Impulsor opcional		
Impeller Code, Código del impulsor	Dia., Diám.	Motor HP, HP del motor
A	8 ¹ / ₄ "	3
B	7 ¹³ / ₁₆	3
C	7	2
D	6 ³ / ₄	2
E	6 ⁷ / ₁₆	2
F	6 ¹ / ₂	2

NOTE: Pump will pass a sphere to ⁵/₃₂" diameter.
 NOTA: La bomba pasará una esfera de ⁵/₃₂" de diámetro máximo.

Performance Curves – M-Group, 60 Hz, 1750 RPM
Curvas de funcionamiento – Grupo M, 60 Hz, 1750 RPM

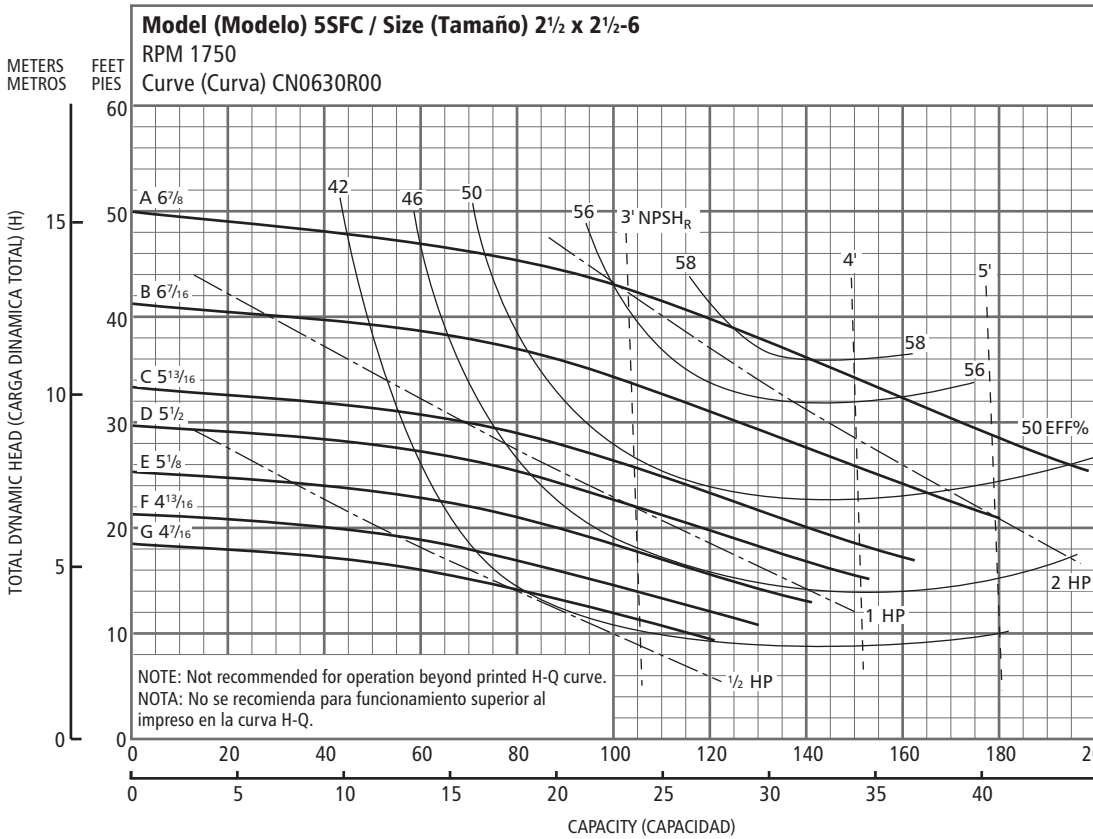

Optional Impeller, Impulsor opcional

Impeller Code, Código del impulsor	Dia., Diám.	Motor HP, HP del motor
A	6⅞"	3
B	6⅞"	2
C	5⅓⅓"	1½
D	5½"	1
E	5⅓"	1
F	4⅓⅓"	¾
G	4⅞"	¾

NOTE: Pump will pass a sphere to ⅝" diameter.
 NOTA: La bomba pasará una esfera de ⅝" de diámetro máximo.

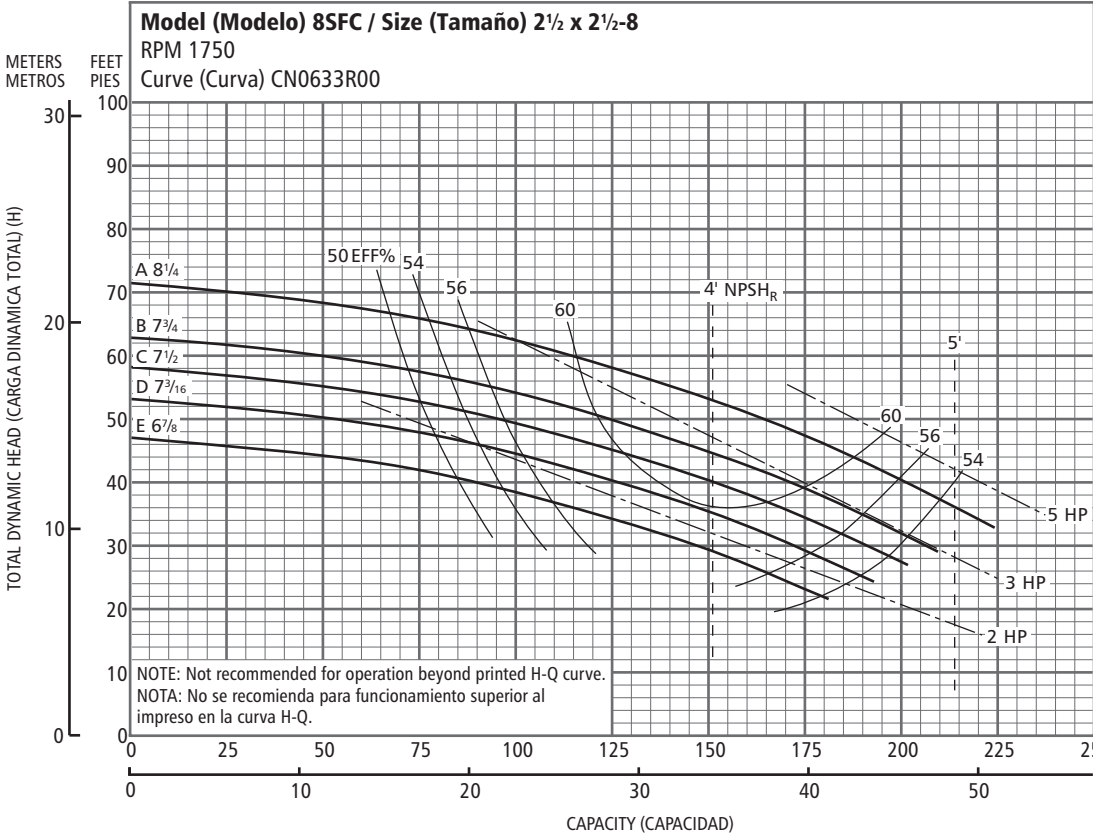

Optional Impeller, Impulsor opcional

Impeller Code, Código del impulsor	Dia., Diám.	Motor HP, HP del motor
A	8¼"	5
B	7¾"	3
C	7½"	3
D	7⅓⅓"	2
E	6⅞"	2

NOTE: Pump will pass a sphere to ⅝" diameter.
 NOTA: La bomba pasará una esfera de ⅝" de diámetro máximo.

Performance Curves – M-Group, 60 Hz, 1750 RPM
Curvas de funcionamiento – Grupo M, 60 Hz, 1750 RPM

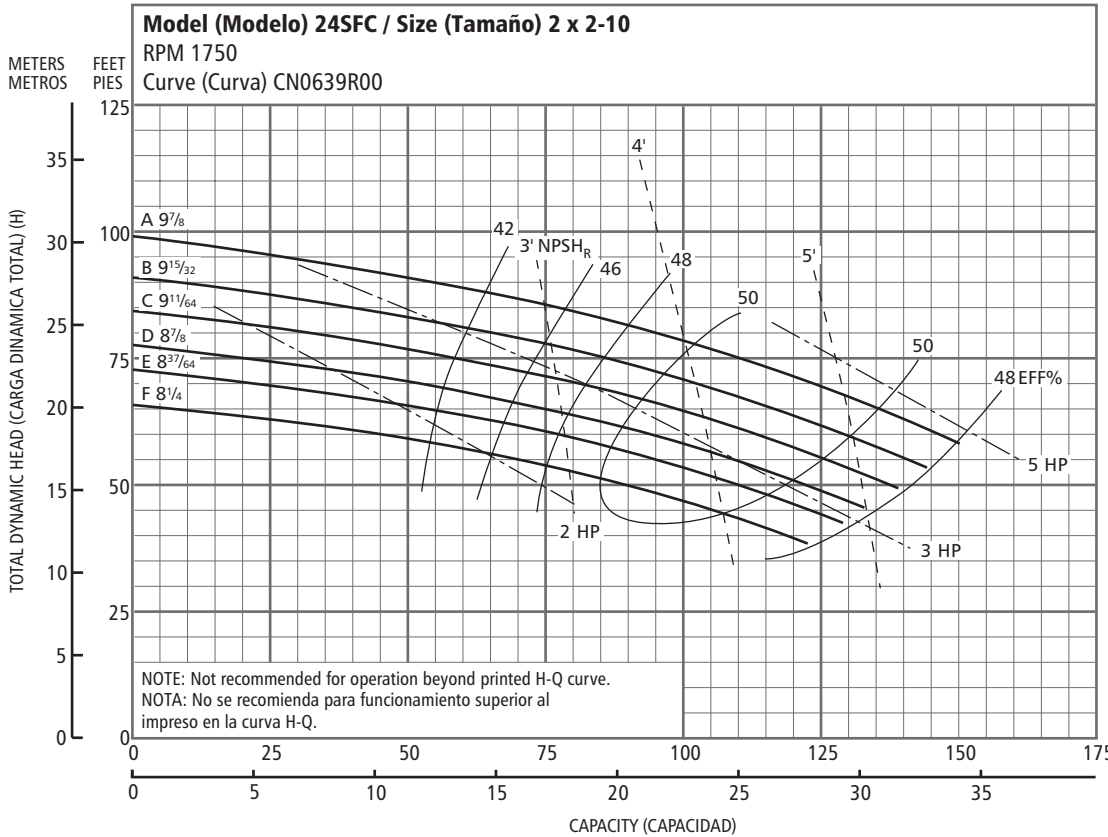

Optional Impeller, Impulsor opcional		
Impeller Code, Código del impulsor	Dia., Diám.	Motor HP, HP del motor
A	9 ⁷ / ₈ "	5
B	9 ¹⁵ / ₃₂	5
C	9 ¹¹ / ₆₄	3
D	8 ⁷ / ₈	3
E	8 ³⁷ / ₆₄	3
F	8 ¹ / ₄	3

NOTE: Pump will pass a sphere to ⁵/₁₆" diameter.
 NOTA: La bomba pasará una esfera de ⁵/₁₆" de diámetro máximo.

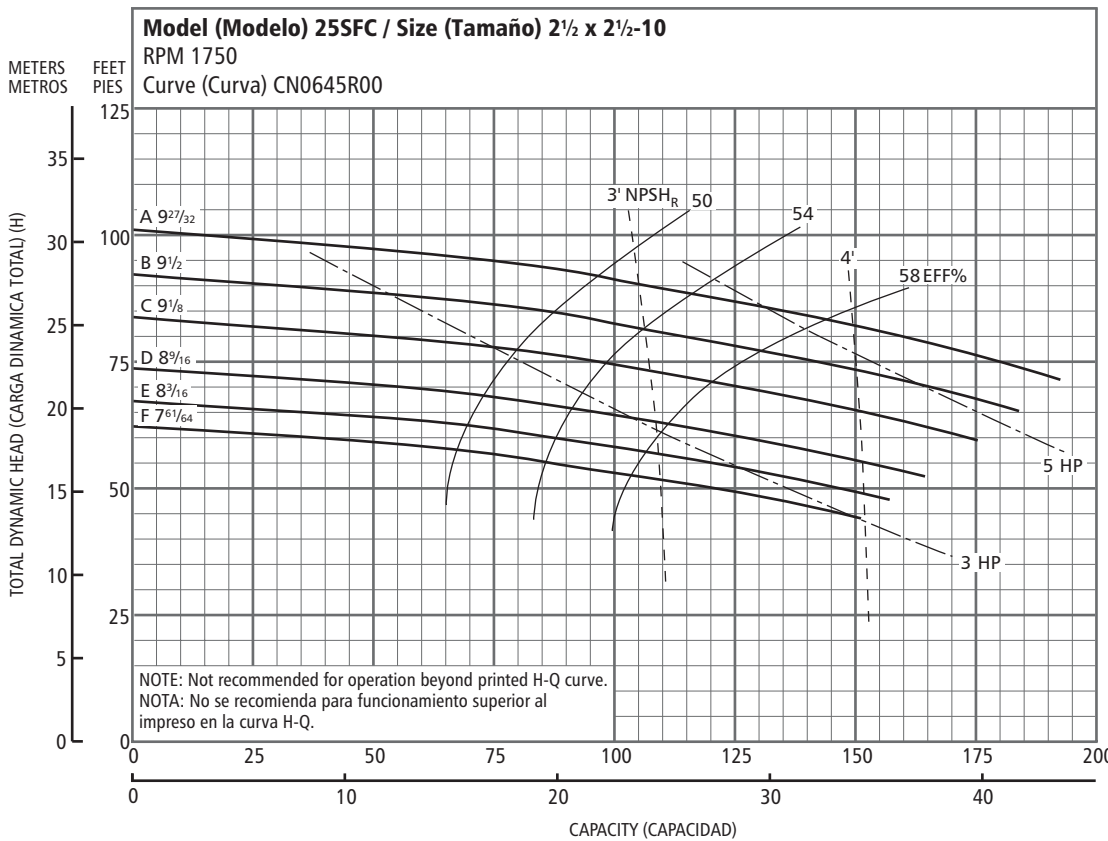

Optional Impeller, Impulsor opcional		
Impeller Code, Código del impulsor	Dia., Diám.	Motor HP, HP del motor
A	9 ²⁷ / ₃₂ "	7 1/2
B	9 1/2	5
C	9 1/8	5
D	8 ⁹ / ₁₆	5
E	8 ³ / ₁₆	3
F	7 ⁶¹ / ₆₄	3

NOTE: Pump will pass a sphere to 1/2" diameter.
 NOTA: La bomba pasará una esfera de 1/2" de diámetro máximo.

Performance Curves – M-Group, 60 Hz, 1750 RPM
Curvas de funcionamiento – Grupo M, 60 Hz, 1750 RPM

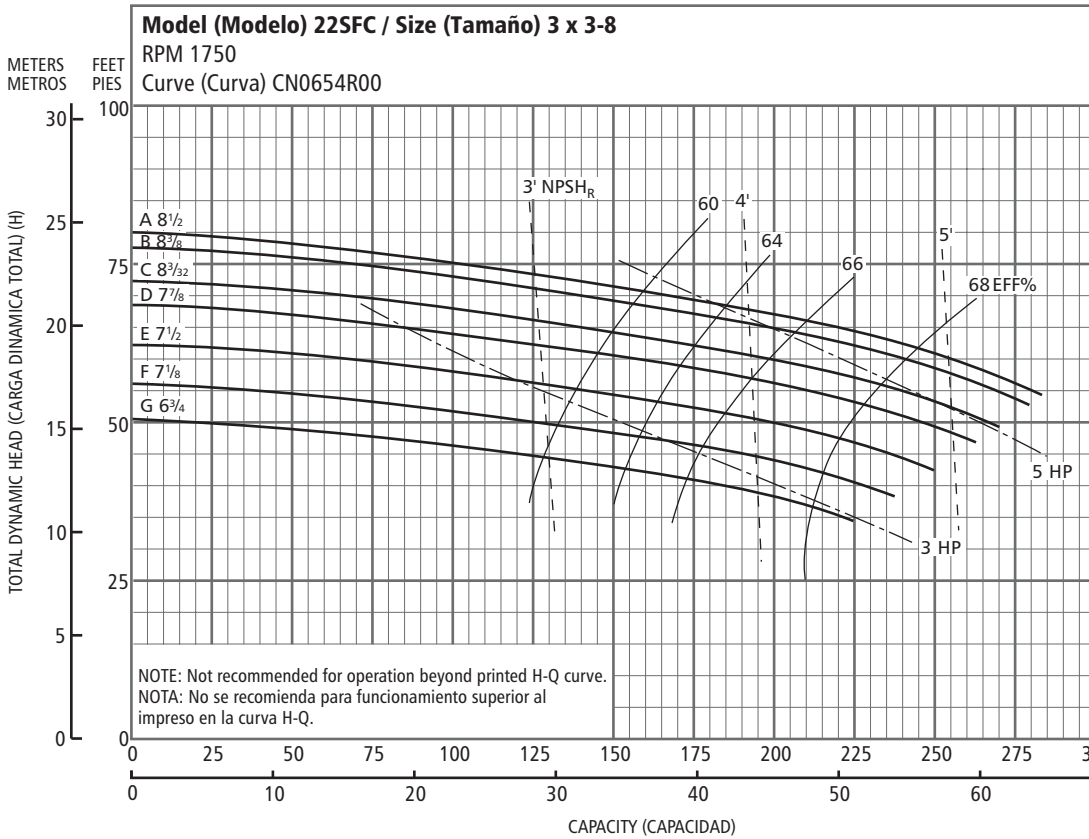

Optional Impeller, Impulsor opcional		
Impeller Code, Código del impulsor	Dia., Diám.	Motor HP, HP del motor
A	8 1/2"	5
B	8 3/8"	5
C	8 3/32"	5
D	7 7/8"	5
E	7 1/2"	5
F	7 1/8"	3
G	6 3/4"	3

NOTE: Pump will pass a sphere to 1 9/32" diameter.
 NOTA: La bomba pasará una esfera de 1 9/32" de diámetro máximo.

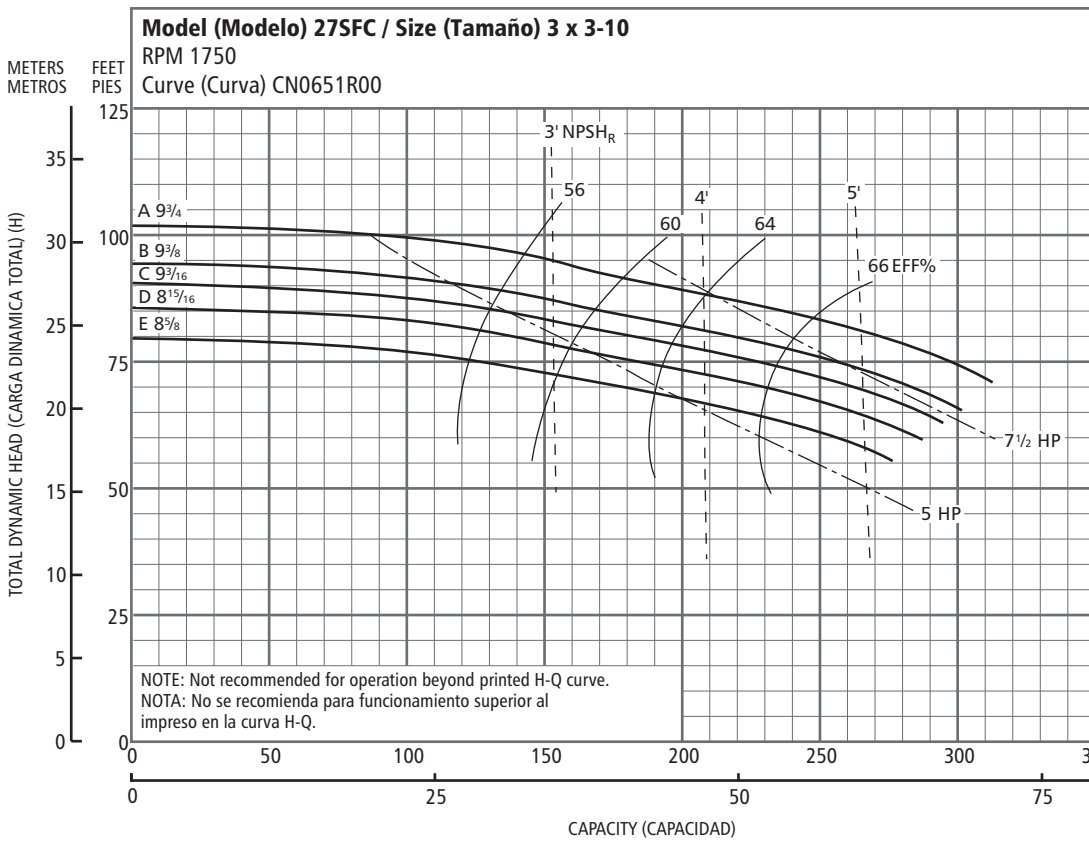

Optional Impeller, Impulsor opcional		
Impeller Code, Código del impulsor	Dia., Diám.	Motor HP, HP del motor
A	9 3/4"	7 1/2
B	9 3/8"	7 1/2
C	9 3/16"	7 1/2
D	8 15/16"	7 1/2
E	8 5/8"	5

NOTE: Pump will pass a sphere to 1 9/32" diameter.
 NOTA: La bomba pasará una esfera de 1 9/32" de diámetro máximo.

Performance Curves – M-Group, 60 Hz, 1750 RPM
Curvas de funcionamiento – Grupo M, 60 Hz, 1750 RPM

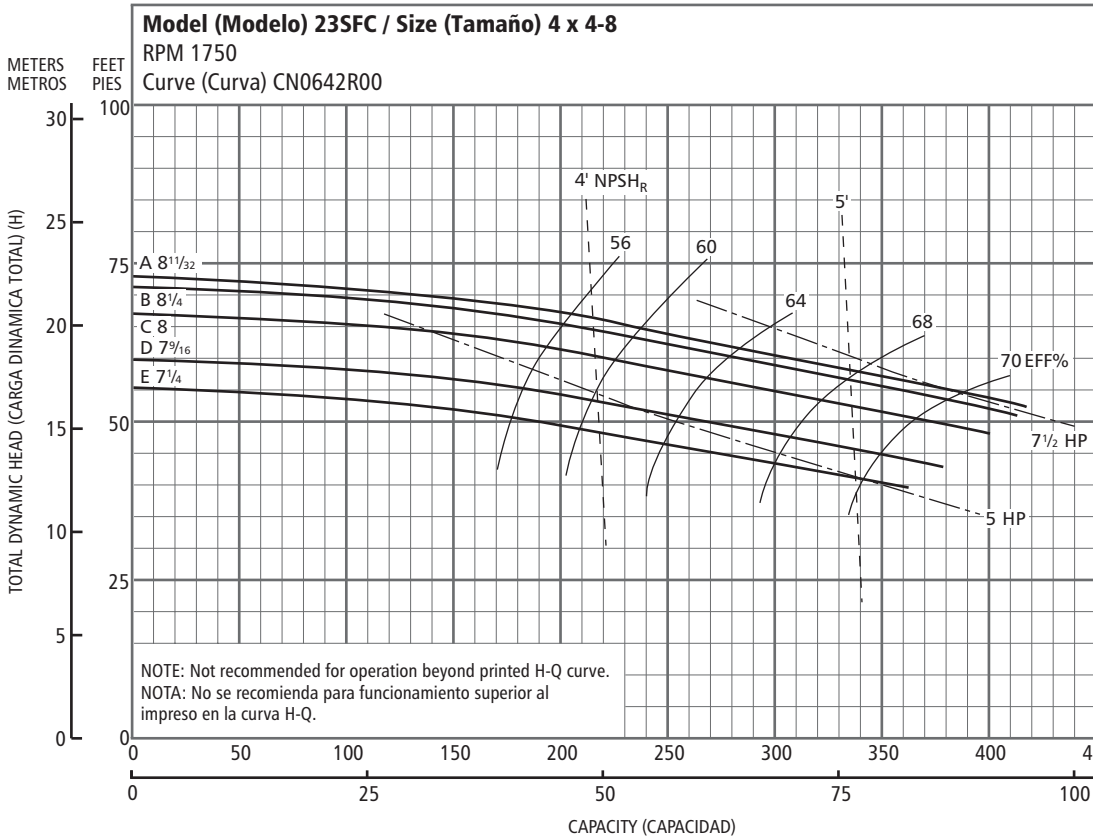

Optional Impeller, Impulsor opcional		
Impeller Code, Código del impulsor	Dia., Diám.	Motor HP, HP del motor
A	8 ¹¹ / ₃₂ "	7 1/2
B	8 ¹ / ₄	7 1/2
C	8	7 1/2
D	7 ⁹ / ₁₆	5
E	7 ¹ / ₄	5

NOTE: Pump will pass a sphere to ⁵/₃₂" diameter.
 NOTA: La bomba pasará una esfera de ⁵/₃₂" de diámetro máximo.

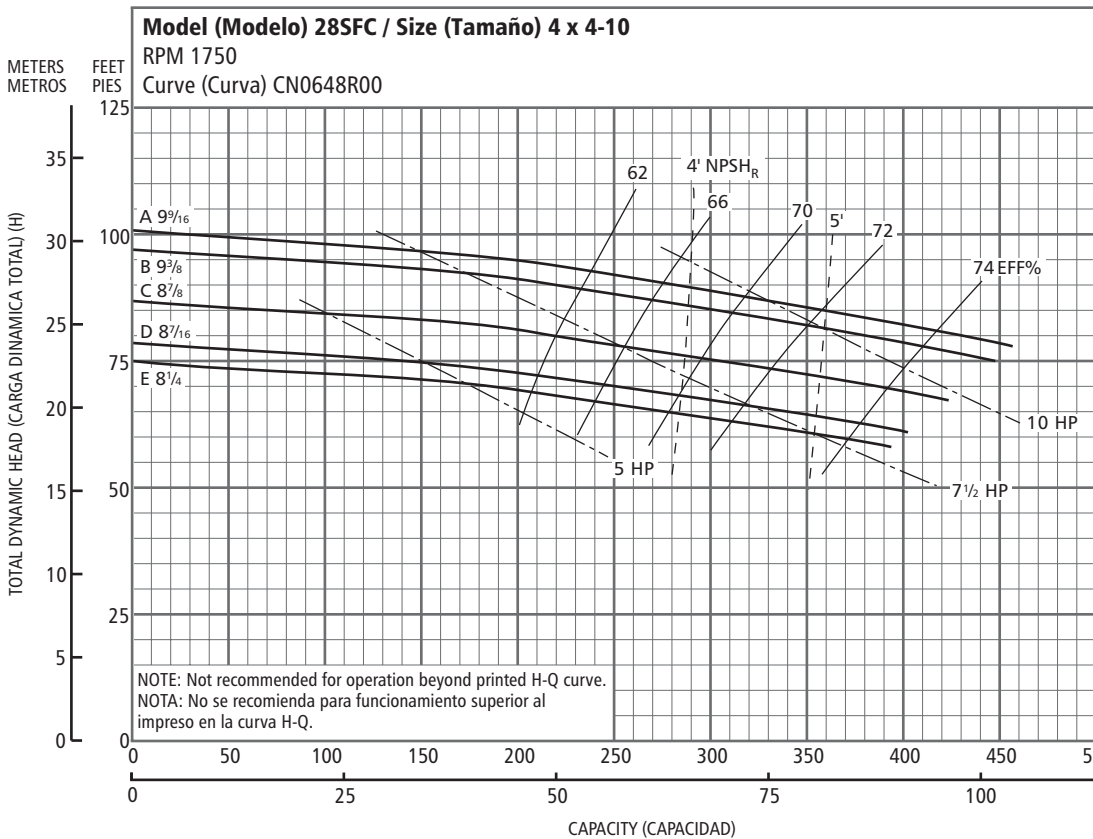

Optional Impeller, Impulsor opcional		
Impeller Code, Código del impulsor	Dia., Diám.	Motor HP, HP del motor
A	9 ⁹ / ₁₆ "	15
B	9 ³ / ₈	10
C	8 ⁷ / ₈	10
D	8 ⁷ / ₁₆	7 1/2
E	8 ¹ / ₄	7 1/2

NOTE: Pump will pass a sphere to ³/₄" diameter.
 NOTA: La bomba pasará una esfera de ³/₄" de diámetro máximo.

Performance Curves – S-Group, 50 Hz, 2900 RPM
Curvas de funcionamiento – Grupo S, 50 Hz, 2900 RPM

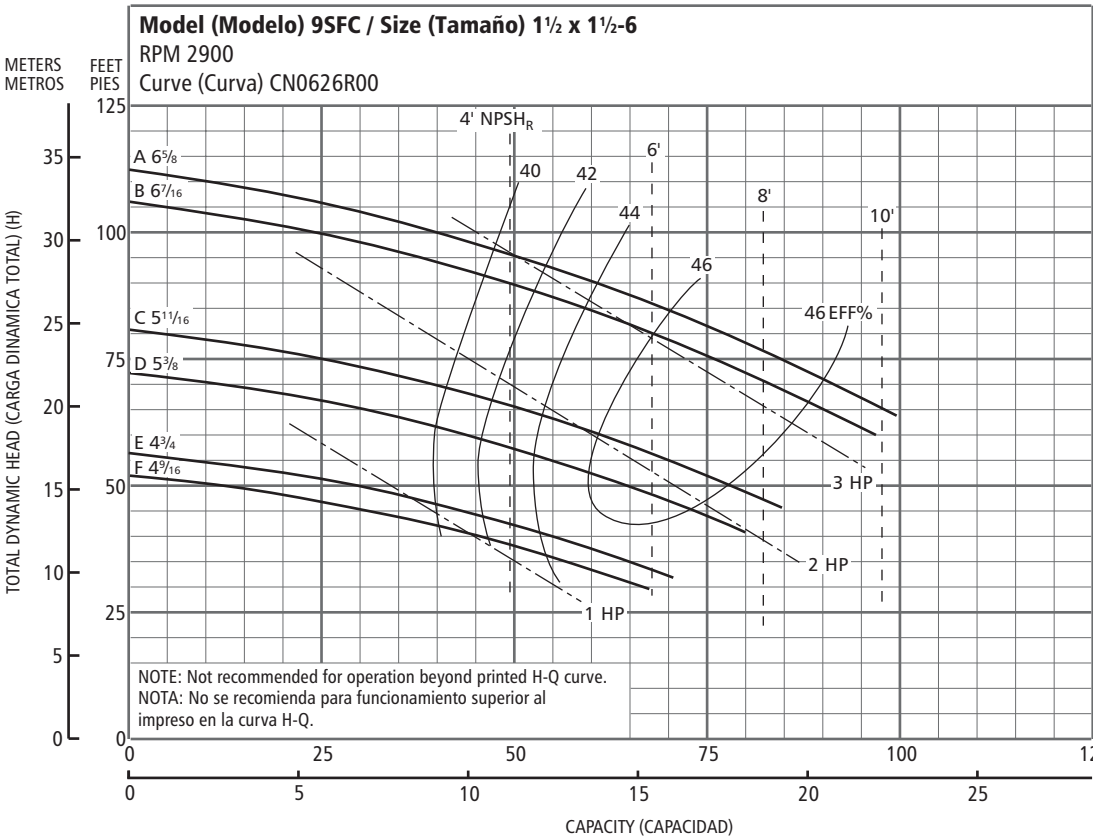

Optional Impeller, Impulsor opcional		
Impeller Code, Código del impulsor	Dia., Diám.	Motor HP, HP del motor
A	6 ⁵ / ₈ "	3
B	6 ⁷ / ₁₆	3
C	5 ¹¹ / ₁₆	2
D	5 ³ / ₈	2
E	4 ³ / ₄	2
F	4 ⁹ / ₁₆	1

NOTE: Pump will pass a sphere to 1/8" diameter.
 NOTA: La bomba pasará una esfera de 1/8" de diámetro máximo.

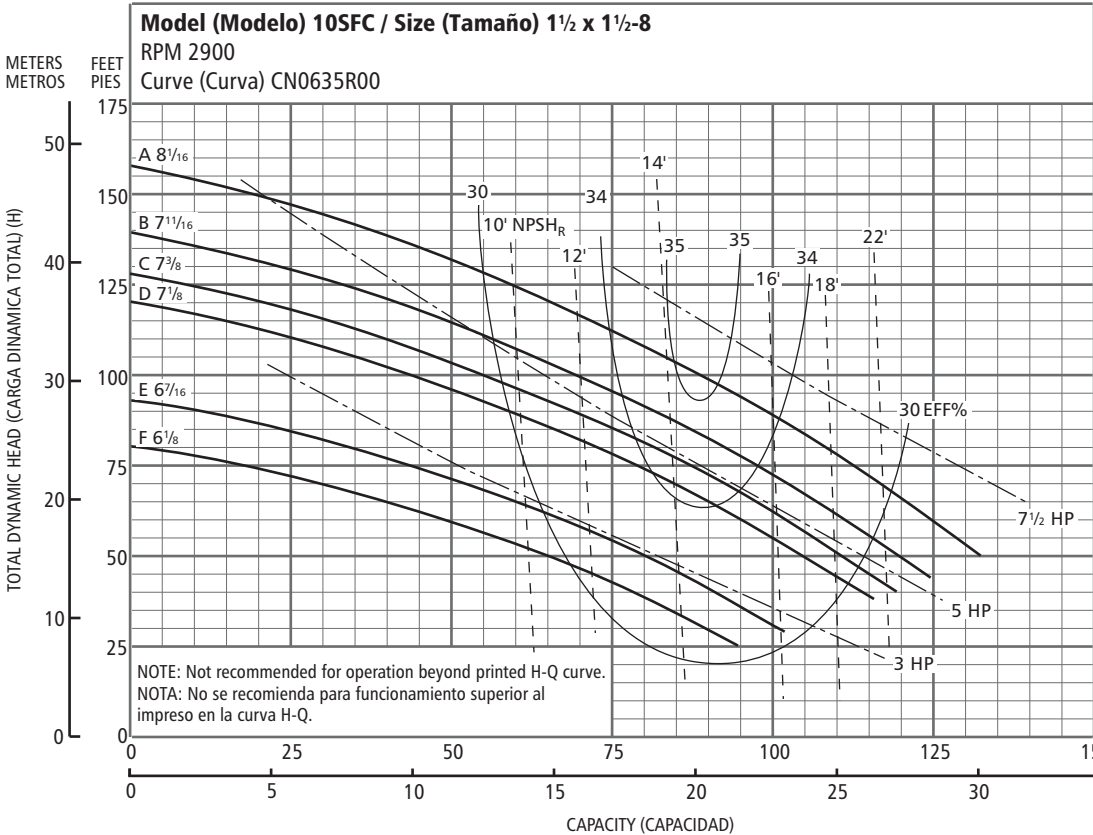

Optional Impeller, Impulsor opcional		
Impeller Code, Código del impulsor	Dia., Diám.	Motor HP, HP del motor
A	8 ¹ / ₁₆ "	7½
B	7 ¹¹ / ₁₆	5
C	7 ³ / ₈	5
D	7 ¹ / ₈	5
E	6 ⁷ / ₁₆	3
F	6 ¹ / ₈	3

NOTE: Pump will pass a sphere to 1/8" diameter.
 NOTA: La bomba pasará una esfera de 1/8" de diámetro máximo.

Performance Curves – S-Group, 50 Hz, 2900 RPM
Curvas de funcionamiento – Grupo S, 50 Hz, 2900 RPM

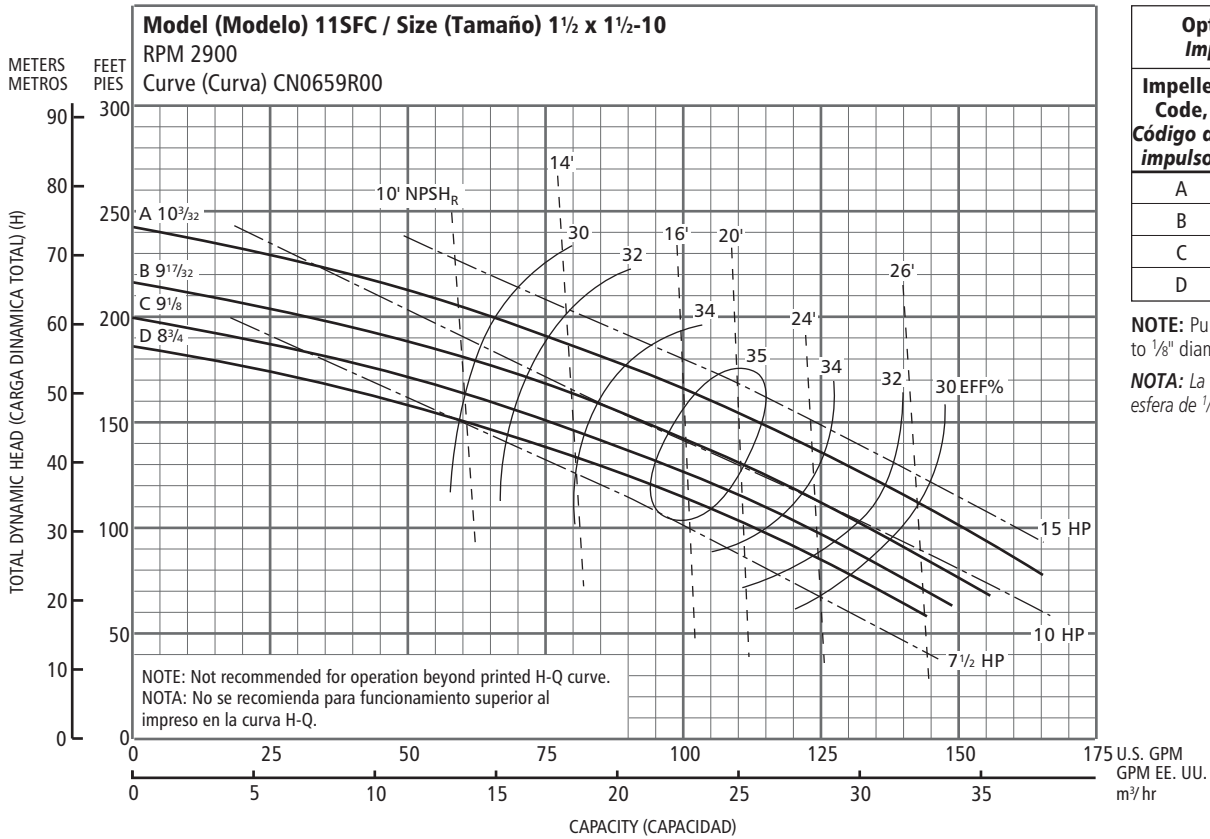

Optional Impeller, Impulsor opcional

Impeller Code, Código del impulsor	Dia., Diám.	Motor HP, HP del motor
A	10 ³ / ₃₂ "	15
B	9 ¹⁷ / ₃₂ "	15
C	9 ¹ / ₈ "	15
D	8 ³ / ₄ "	7 1/2

NOTE: Pump will pass a sphere to 1/8" diameter.
 NOTA: La bomba pasará una esfera de 1/8" de diámetro máximo.

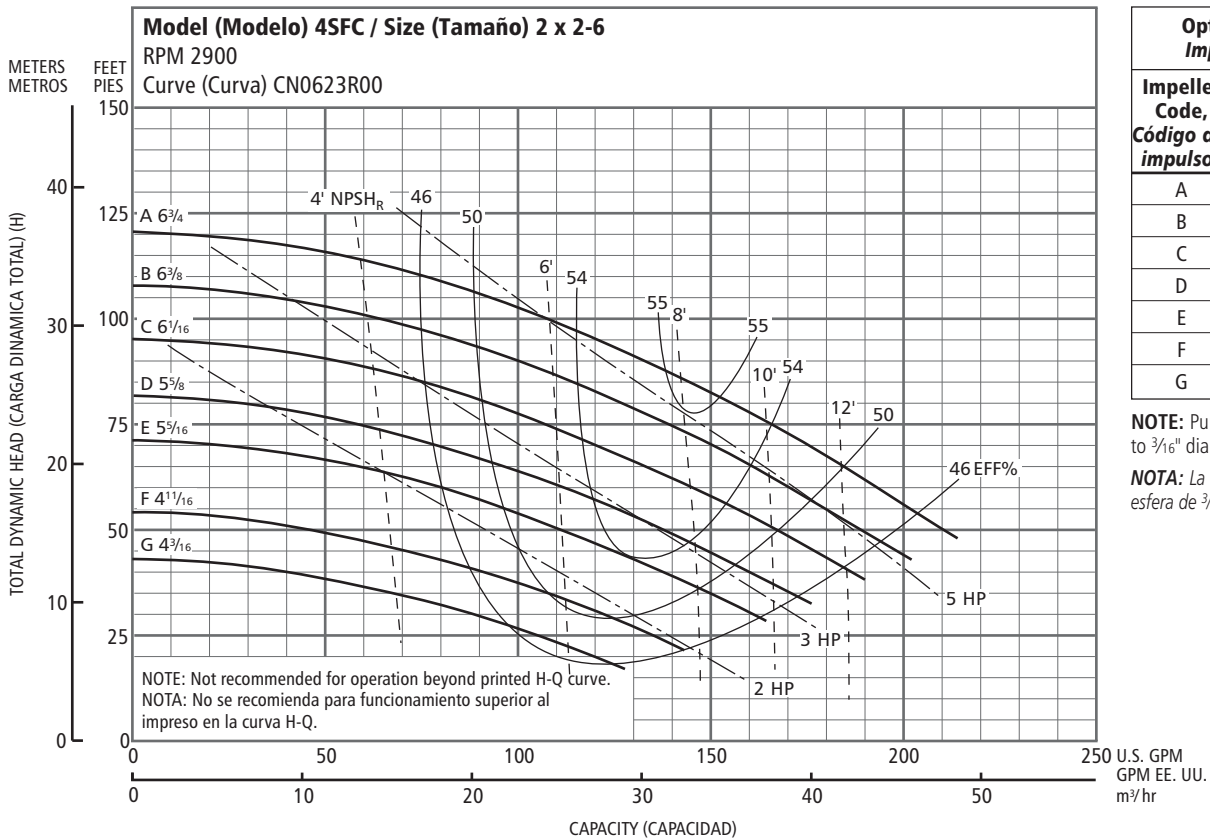

Optional Impeller, Impulsor opcional

Impeller Code, Código del impulsor	Dia., Diám.	Motor HP, HP del motor
A	6 ³ / ₄ "	7 1/2
B	6 ³ / ₈ "	5
C	6 ¹ / ₁₆ "	5
D	5 ⁵ / ₈ "	3
E	5 ⁵ / ₁₆ "	3
F	4 ¹¹ / ₁₆ "	2
G	4 ³ / ₁₆ "	2

NOTE: Pump will pass a sphere to 3/16" diameter.
 NOTA: La bomba pasará una esfera de 3/16" de diámetro máximo.

Performance Curves – S-Group, 50 Hz, 2900 RPM
Curvas de funcionamiento – Grupo S, 50 Hz, 2900 RPM

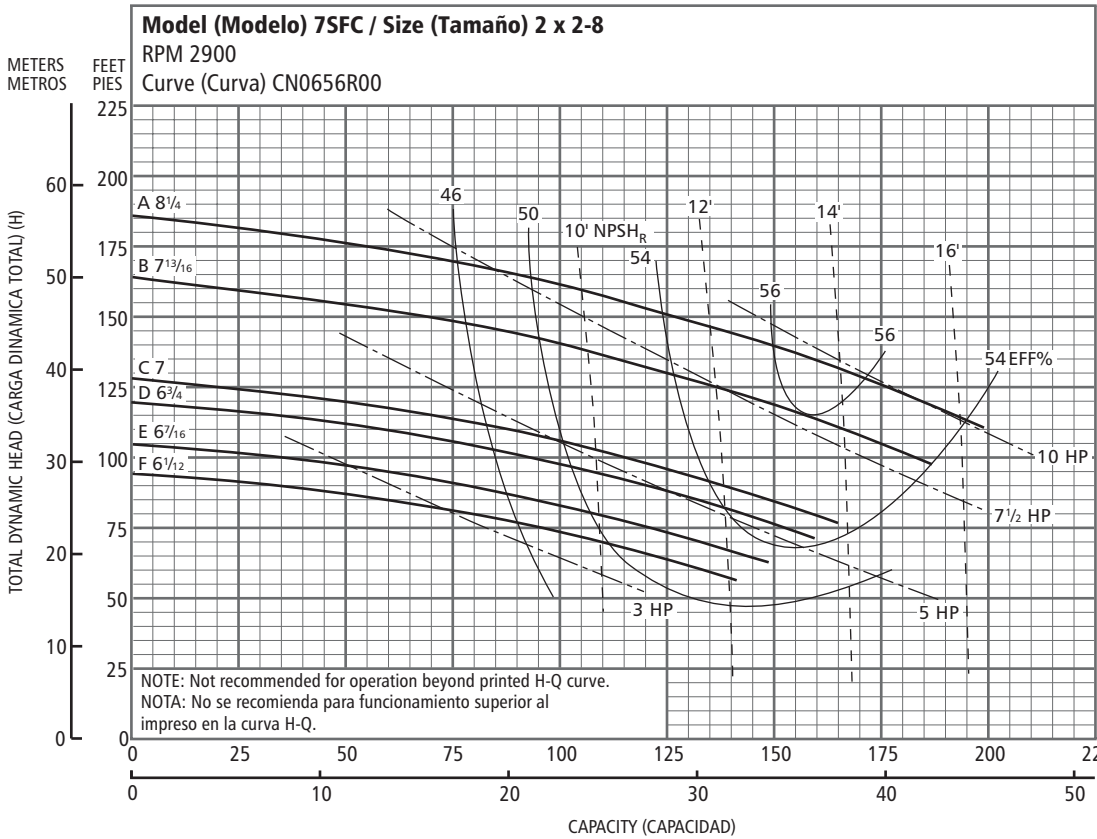

Optional Impeller, Impulsor opcional

Impeller Code, Código del impulsor	Dia., Diám.	Motor HP, HP del motor
A	8 1/4"	10
B	7 13/16	7 1/2
C	7	7 1/2
D	6 3/4	5
E	6 7/16	5
F	6 1/2	5

NOTE: Pump will pass a sphere to 3/16" diameter.
 NOTA: La bomba pasará una esfera de 3/16" de diámetro máximo.

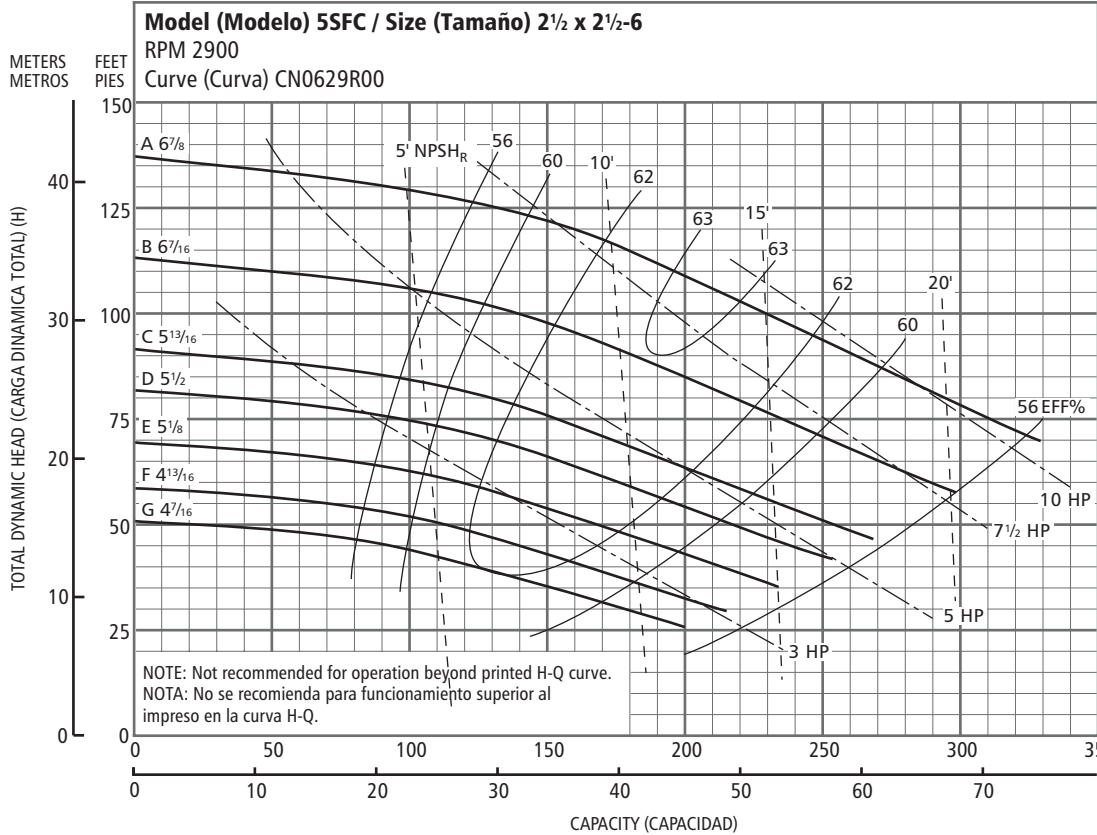

Optional Impeller, Impulsor opcional

Impeller Code, Código del impulsor	Dia., Diám.	Motor HP, HP del motor
A	6 7/8"	10
B	6 7/16	7 1/2
C	5 13/16	5
D	5 1/2	5
E	5 1/8	5
F	4 13/16	3
G	4 7/16	3

NOTE: Pump will pass a sphere to 5/32" diameter.
 NOTA: La bomba pasará una esfera de 5/32" de diámetro máximo.

Performance Curves – M-Group, 50 Hz, 2900 RPM
Curvas de funcionamiento – Grupo M, 50 Hz, 2900 RPM

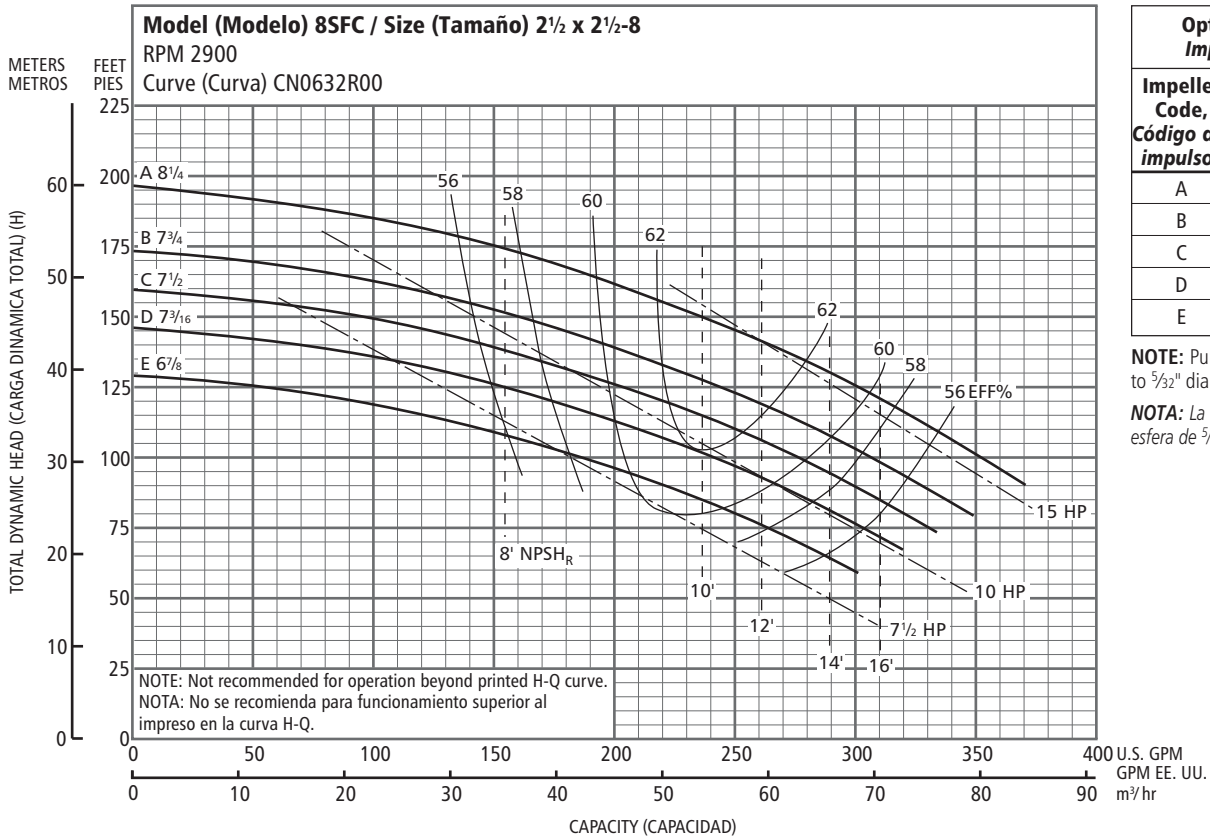

Optional Impeller, Impulsor opcional

Impeller Code, Código del impulsor	Dia., Diám.	Motor HP, HP del motor
A	8 1/4"	15
B	7 3/4"	15
C	7 1/2"	15
D	7 3/16"	10
E	6 7/8"	10

NOTE: Pump will pass a sphere to 5/32" diameter.
 NOTA: La bomba pasará una esfera de 5/32" de diámetro máximo.

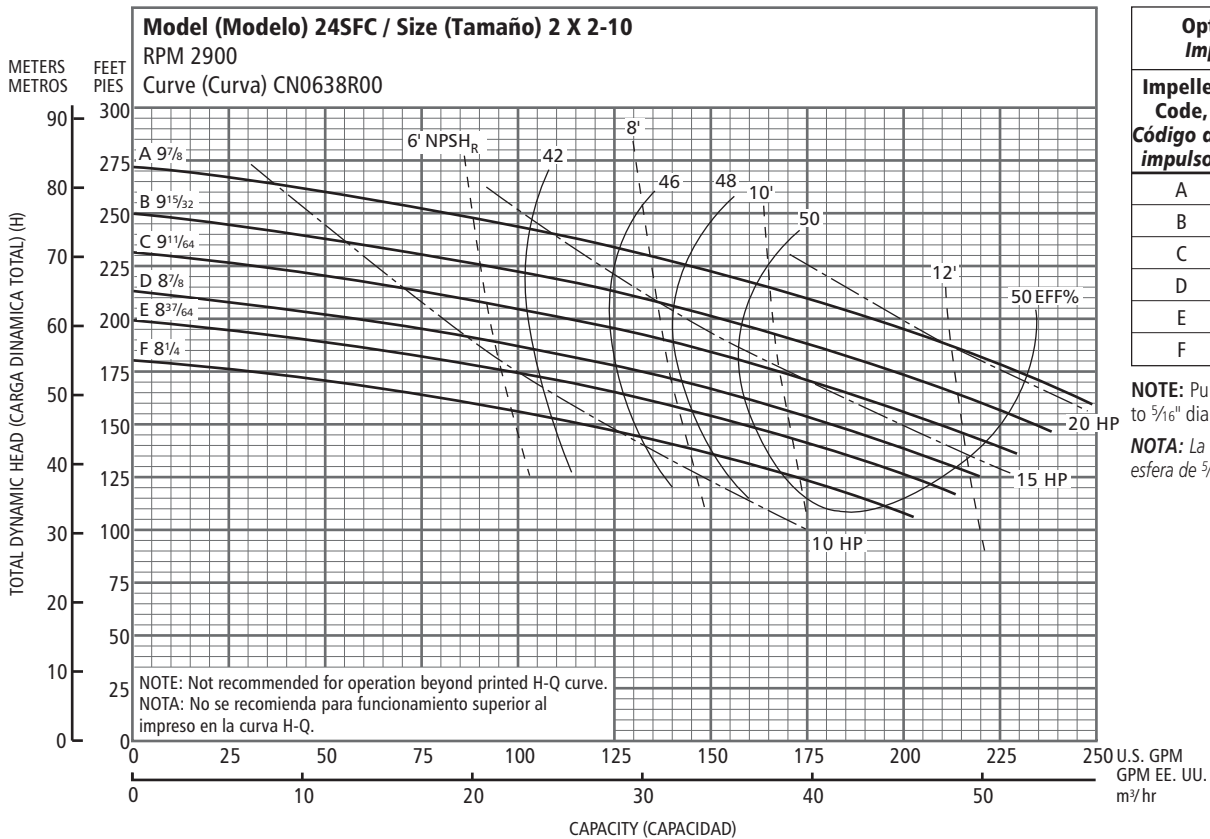

Optional Impeller, Impulsor opcional

Impeller Code, Código del impulsor	Dia., Diám.	Motor HP, HP del motor
A	9 7/8"	20
B	9 15/32"	20
C	9 1 1/64"	15
D	8 7/8"	15
E	8 37/64"	15
F	8 1/4"	10

NOTE: Pump will pass a sphere to 5/16" diameter.
 NOTA: La bomba pasará una esfera de 5/16" de diámetro máximo.

Performance Curves – M-Group, 50 Hz, 2900 RPM
Curvas de funcionamiento – Grupo M, 50 Hz, 2900 RPM

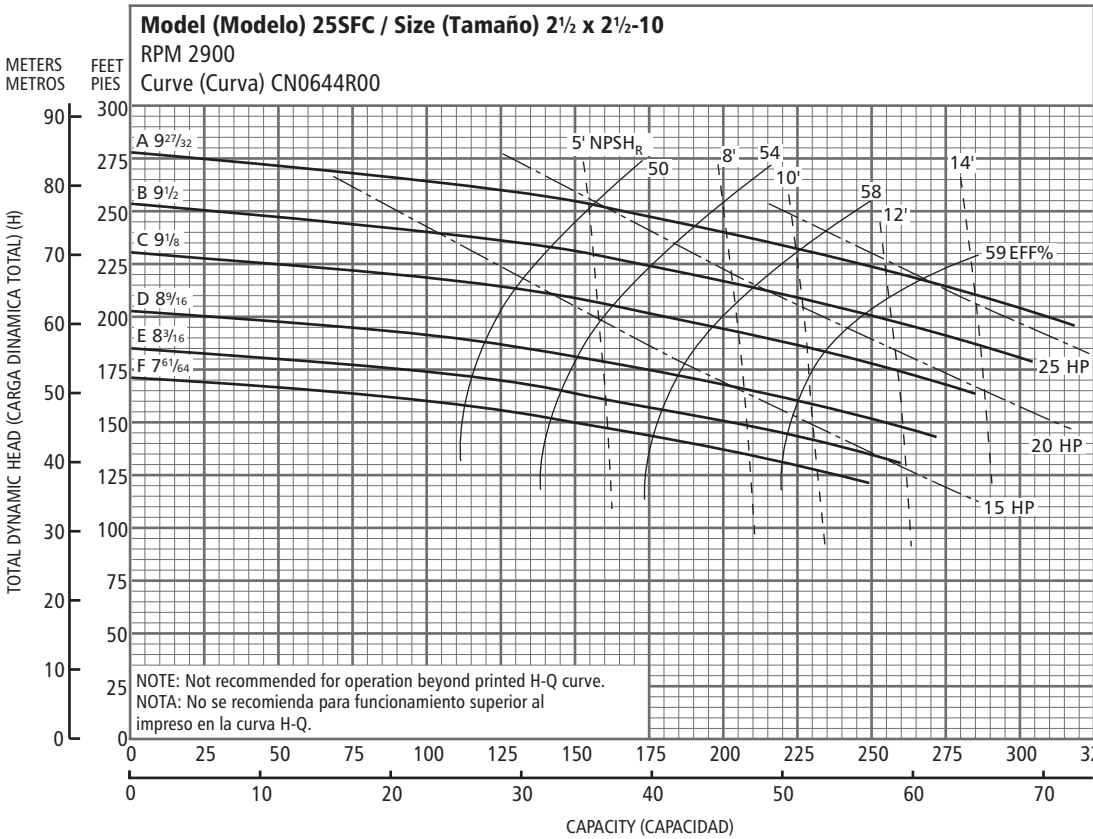

Optional Impeller, Impulsor opcional

Impeller Code, Código del impulsor	Dia., Diám.	Motor HP, HP del motor
A	9 ²⁷ / ₃₂ "	25
B	9½	25
C	9⅞	20
D	8 ⁹ / ₁₆	15
E	8 ³ / ₁₆	15
F	7 ⁶ / ₆₄	15

NOTE: Pump will pass a sphere to ½" diameter.
 NOTA: La bomba pasará una esfera de ½" de diámetro máximo.

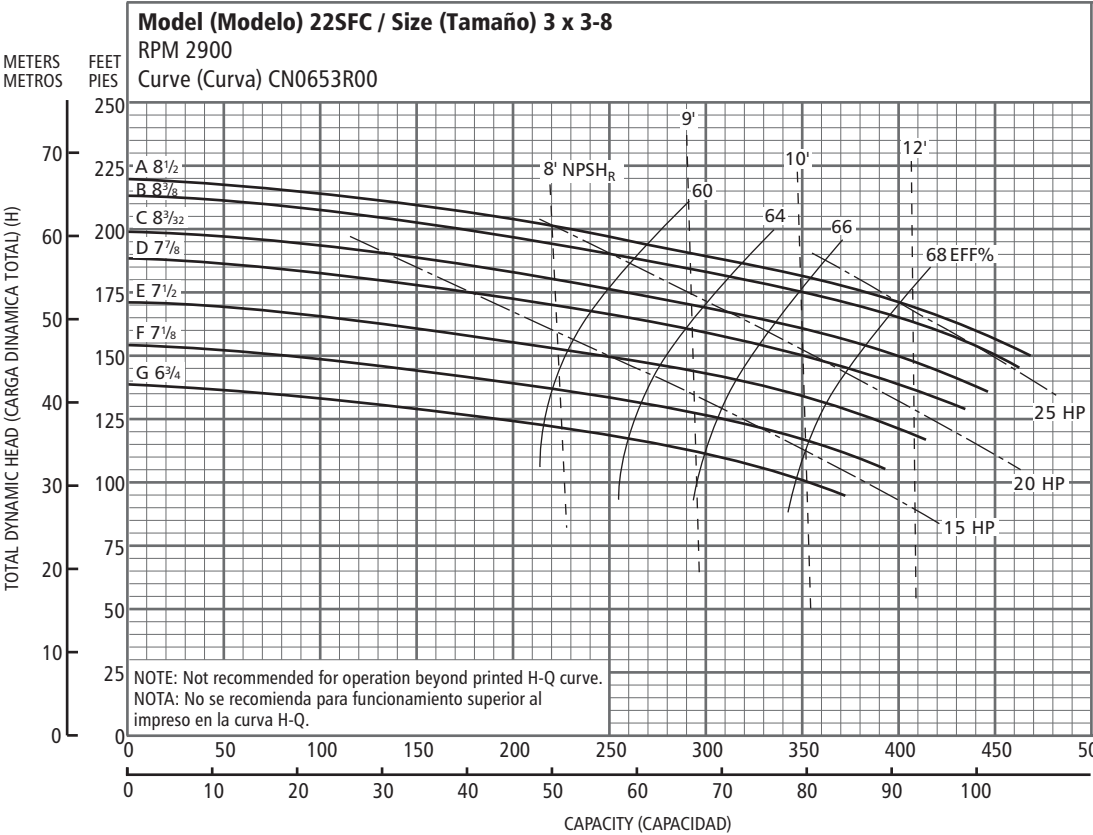

Optional Impeller, Impulsor opcional

Impeller Code, Código del impulsor	Dia., Diám.	Motor HP, HP del motor
A	8½	25
B	8 ³ / ₈	25
C	8 ³ / ₃₂	20
D	7 ⁷ / ₈	20
E	7½	20
F	7⅞	15
G	6¾	15

NOTE: Pump will pass a sphere to 19/32" diameter.
 NOTA: La bomba pasará una esfera de 19/32" de diámetro máximo.

Performance Curves – M-Group, 50 Hz, 2900 RPM
Curvas de funcionamiento – Grupo M, 50 Hz, 2900 RPM

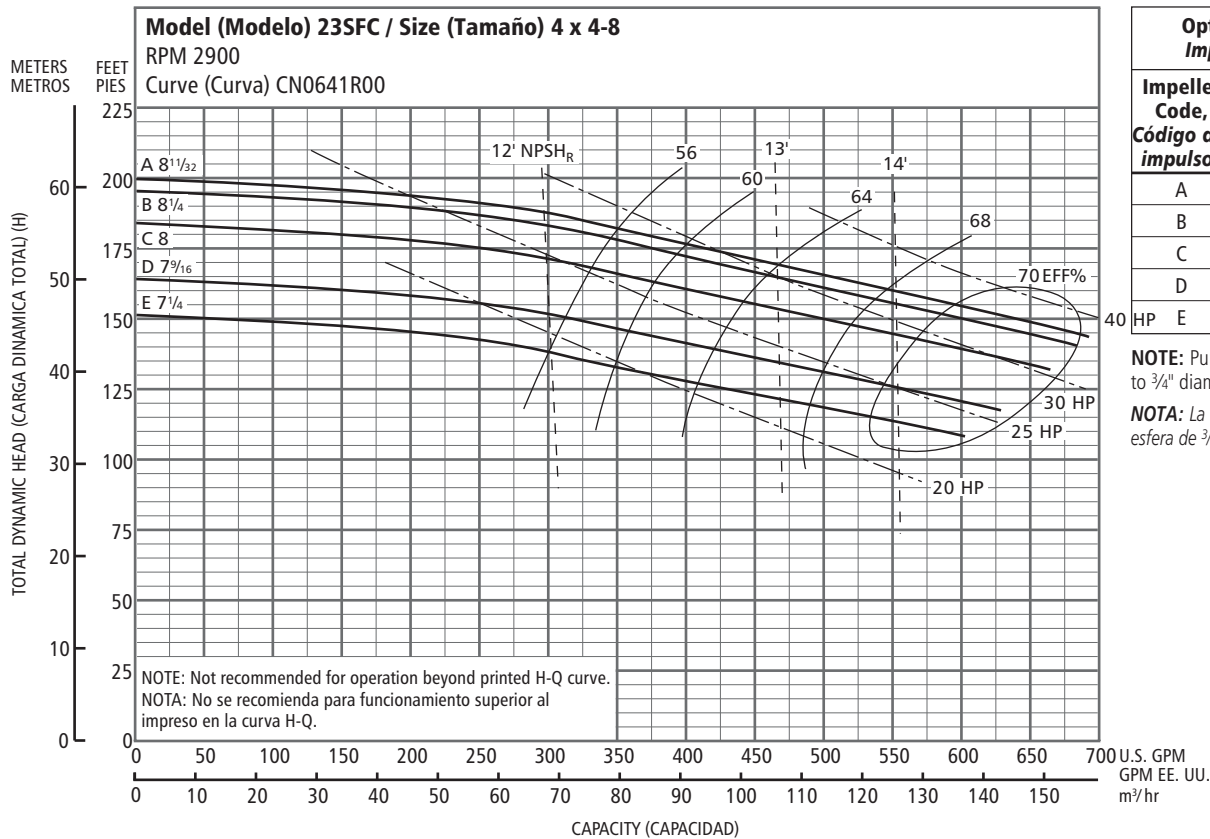
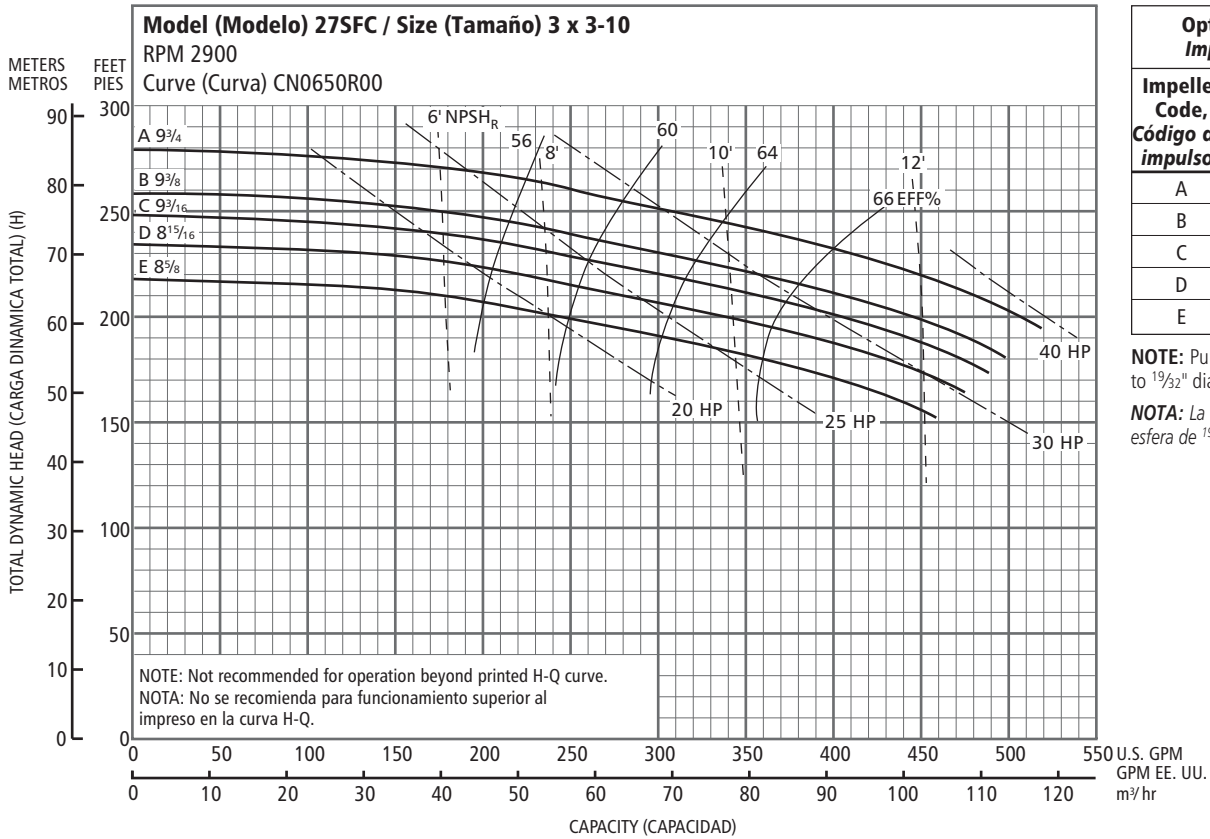

Performance Curves – M-Group, 50 Hz, 2900 RPM
Curvas de funcionamiento – Grupo M, 50 Hz, 2900 RPM

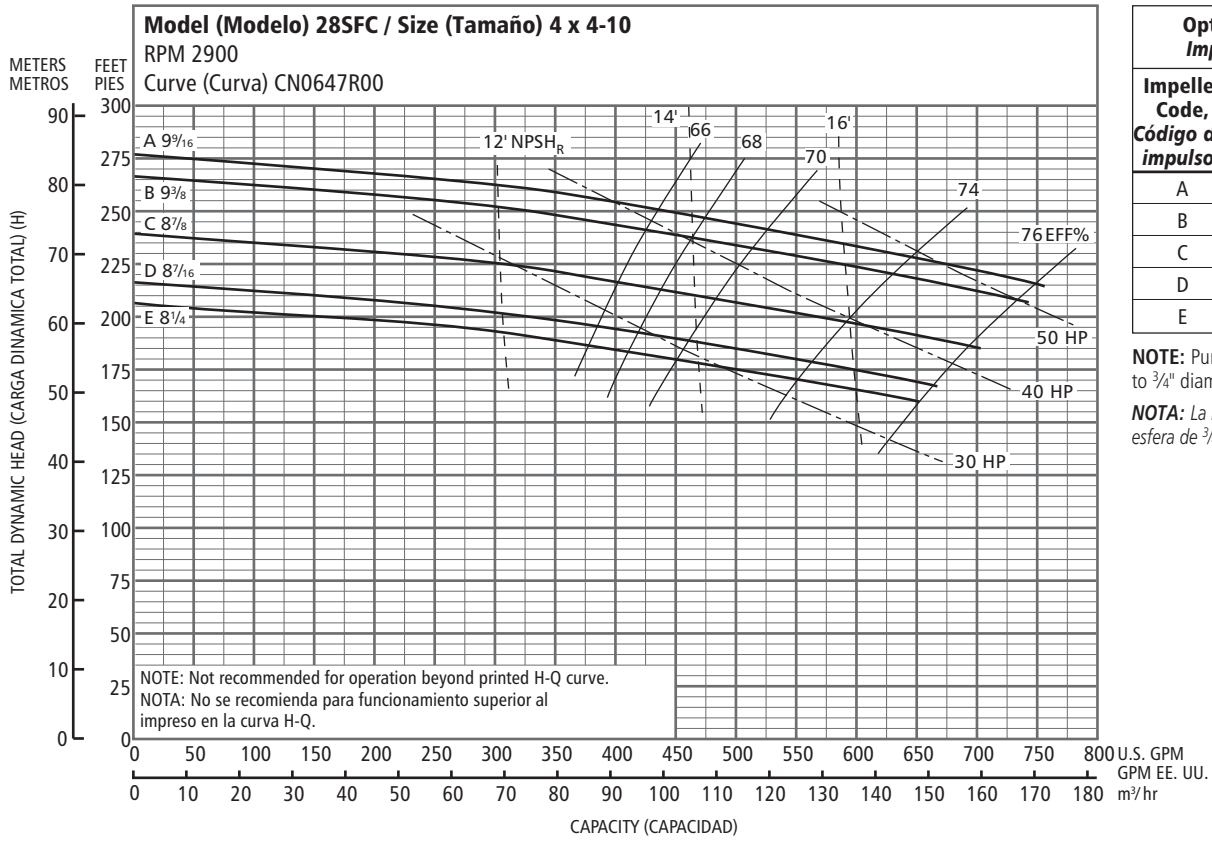

Optional Impeller, Impulsor opcional		
Impeller Code, Código del impulsor	Dia., Diám.	Motor HP, HP del motor
A	9 ⁹ / ₁₆	50
B	9 ³ / ₈	50
C	8 ⁷ / ₈	40
D	8 ⁷ / ₁₆	40
E	8 ¹ / ₄	30

NOTE: Pump will pass a sphere to 3/4" diameter.

NOTA: La bomba pasará una esfera de 3/4" de diámetro máximo.

**SFC – Dimensions and Weights,
SFC – Dimensiones y pesos**

Motor Frame Selections, Selecciones del armazón del motor

Motor Frame, Armazón del motor	Motor Horsepower, Potencia del motor								Motor Wt. (lbs.) Peso motor (lib.)
	3500 RPM, 3500 RPM				1750 RPM, 1750 RPM				
	1Ø, Monofásicos		3Ø, Trifásicos		1Ø, Monofásicos		3Ø, Trifásicos		
	ODP	TEFC	ODP	TEFC	ODP	TEFC	ODP	TEFC	
143JP	1/2-1 1/2	1/2-1 1/2	1/2-1 1/2	1/2-1 1/2	1/2-1	1/2-3/4	1/2-3/4	1/2-3/4	41
145JP	2	2	2-3	2	1 1/2	1-1 1/2	1 1/2-2	1 1/2-2	57
182JP	3	3	5	3	2	2-3	3	3	77
184JP	5	5	7 1/2	5	3	—	5	5	97
213JP	7 1/2	—	10	—	5	—	7 1/2	7 1/2	122
215JP	10	—	15	10, 15	5, 10	—	10	10	155
254JP	—	—	20	—	—	—	15	15	266
256JP	—	—	25	20	—	—	20	20	320
284JP	—	—	30	25	—	—	25	25	392
286JP	—	—	40	30	—	—	30	30	422
324JP	—	—	50	40	—	—	40	40	520
326JP	—	—	60	50	—	—	50	50	600
213TCZ	7 1/2	—	10	—	—	—	7 1/2	7 1/2	122
215TCZ	10	—	10-15	15	—	—	—	—	156
254TCZ	—	—	20	—	—	—	—	—	265
256TCZ	—	—	25	20-25	—	—	—	—	320
364TCZ	—	—	75	60, 75	—	—	60	60	750
365TCZ	—	—	—	—	—	—	75	75	804

**Dimensions Determined by JP Motor Frame,
Dimensiones determinadas por el armazón del motor JP**

JP Frame, Armazón JP	C Ref.	P Ref.
143JP	1 1/4	6 5/8
145JP		
182JP	1 3/8	7 7/8
184JP		
213JP	1 5/8	9 5/8
215JP		
254JP	2 0 1/2	12 15/16
256JP		
284JP	2 3 7/8	13 1/2
286JP		
324JP	2 5 1/2	15 1/8
326JP		

JP Frame, Armazón JP	C Ref.	P Ref.
213TCZ	15 1/2	9 5/8
215TCZ		
254TCZ	20 1/2	12 15/16
256TCZ		
364TCZ	28	17 7/8
365TCZ		

NOTE:
1. ALL dimensions in inches,
2. Motor dimensions may vary with motor manufacturer.
3. Not for construction purposes.

NOTA:
1. TODAS las dimensiones en pulgadas.
2. Las dimensiones puede que varien con los fabricantes.
3. No usar para propósitos de construcción.

SFC (WITH SUPPORT), SFC (CON APOYO)
CLEARANCE FOR DISASSEMBLY, ESPACIAMIENTO PARA EL DESMONTAJE

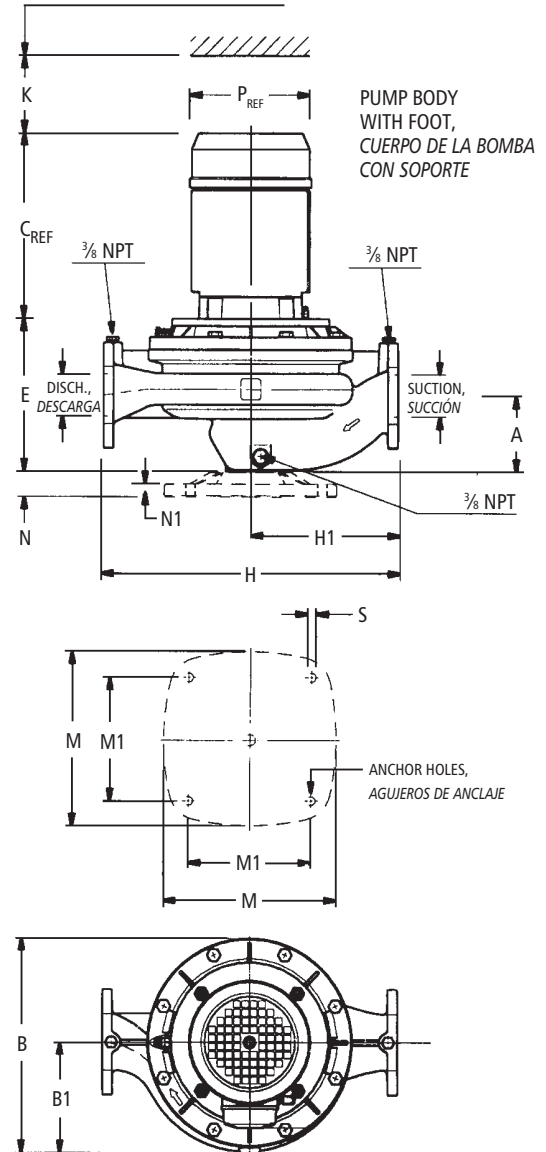

Pump Size, Tamaño de la Bomba	125 lb. F.F. Flange, Brida de cara elevada de 125 lbs.		Dimension Determined by Pump, Dimensión determinada por la bomba													
	Discharge, Descarga	Suction, Succión	A	B	B1	E	H	H1	K	M	M1	S	N	N1	Wt. (lbs.)	
9SC	40-160	1 1/2	1 1/2	2.75	9.00	4.50	10.30	12.38	6.19	5.00	Pump Support Not Available No se ofrece apoyo para la bomba					45
4SC	50-160	2	2				10.57	13.14	6.57							50
5SC	65-160	2 1/2	2 1/2	3.03	10.88	5.44	11.26	17.09	8.55	6.00						90
10SC	40-200	1 1/2	1 1/2				11.06									12.18
7SC	50-200	2	2	4.33	12.81	6.41	12.38	18.46	9.23	6.50						85
8SC	65-200	2 1/2	2 1/2				4.69	17.09	8.55							125
11SC	40-250	1 1/2	1 1/2	3.75	9.00	4.50	—	17.09	8.55	6.50						75
24SC	50-250	2	2				4.33									12.19
25SC	65-250	2 1/2	2 1/2	4.69	12.81	6.41	12.38	18.46	9.23	6.50	10.83	7.69	3/16	1.62	0.81	125
22SC	80-200	3	3				5.12	14.14	19.44							9.72
23SC	100-200	4	4	5.52	12.69	6.35	14.97	21.44	10.72	7.50						145
27SC	80-250	3	3				5.12	14.14	19.44							9.72
28SC	100-250	4	4	5.52	14.97	21.44	10.72	7.50	145							

(All dimensions in inches and weights in lbs. Do not use for construction purposes.) (Todas las dimensiones en pulgadas y los pesos en libras. No usar para propósitos de construcción.)

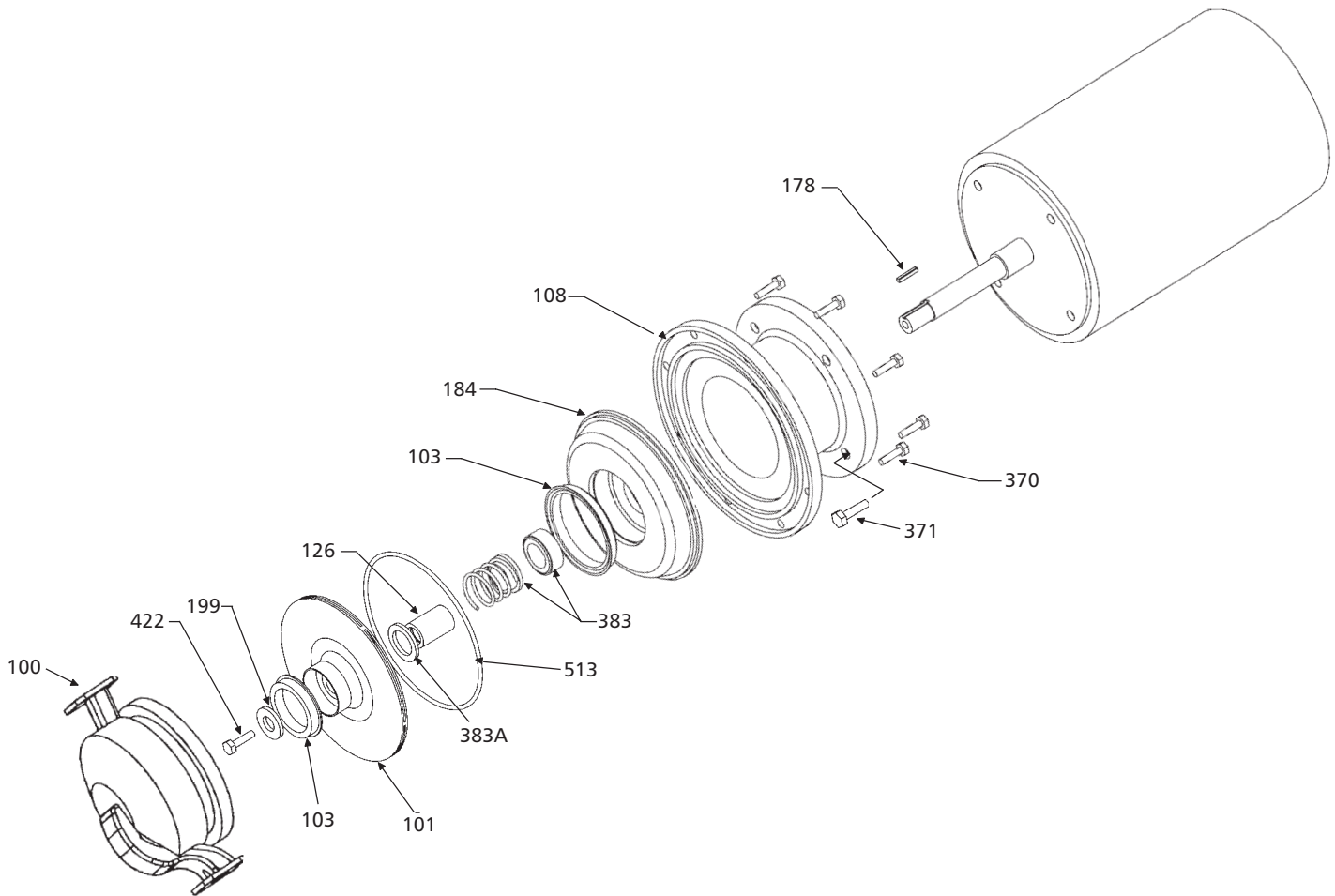

Item No., Parte No.	Description, Descripción	Materials, Materiales
100	Casing, Carcasa	Cast Iron, Hierro fundido
101	Impeller, Impulsor	316L SS*, Acero inox. 316L*
103	Wear ring, Anillo de desgaste	316 SS, Acero inox. 316
184	Seal housing, Alojamiento del sello	Cast Iron, Hierro fundido
178	Impeller key, Chaveta del impulsor	Steel, Acero
126	Shaft sleeve, Camisa del eje	316 SS, Acero inox. 316
422	Impeller Bolt, Perno del impulsor	304 SS, Acero inox. 304
199	Impeller washer, Arandela del impulsor	304 SS, Acero inox. 304
370	Casing bolt (casing to adapter), Tornillo de casquete de la carcasa (carcasa al adaptador)	Carbon Steel, Plated, Ac. al carbón, enchapado
108	Adapter, Adaptador	Cast iron, Hierro fundido
371	Hex head cap screw (adapter to motor), Tornillo de cabeza hexagonal (adaptador al motor)	Carbon Steel, Plated, Ac. al carbón, enchapado
513	O-ring casing, Anillo en O carcasa	BUNA-N (standard, estándar)
383	Mechanical seal, Sello mecánico	See seal chart, page 3 Ver tabla del sello, pagina 3
383A	Retainer, Seal Spring, Retén, resorte del sello	304 SS, Acero inox. 304

* 22/23/27/28 sizes have cast iron impeller., Los tamaños 22/23/27/28 tienen impulsores de hierro fundido.

Specifications Especificaciones

Capacities to:

950 GPM (216 m³/hr)
at 3500 RPM
450 GPM (102 m³/hr)
at 1750 RPM

Heads to:

400 feet THD (120 m) at 3500 RPM,
100 feet THD (32 m) at 1750 RPM

Maximum working pressures to:

175 PSI (12 bars)

Maximum temperatures to:

212°F (100°C) with standard seal
or 250°F (121°C) with optional
high temperature seal.

Materials of Construction:

Impellers - 316L SS (22/23/27/28 sizes have cast iron impellers)
Casing and Seal Housing -
Cast Iron

Rotation: Clockwise when viewed from motor end.

Enclosed impeller and replaceable wear ring:

for high efficiency and maximum wear life.

Motor (close coupled):

NEMA standard JP shaft open drip-proof, totally enclosed and explosion-proof enclosures, 60 Hz, 1750 or 3500 RPM.

Single phase

ODP/TEFC/EXP. (115/230 V)
1750 RPM, ½ – 10 HP.
3500 RPM, ½ – 10 HP.

Three phase ODP/TEFC/EXP.
(208 – 230/460 V).

1750 RPM, ½ – 30 HP
3500 RPM, ½ – 75 HP

NOTE: Overload protection must be provided. Contactor with overload for single phase or starter with heaters for three phase ordered separately.

Capacidades:

950 GPM (216 m³/hr) a 3500 RPM
450 GPM (102 m³/hr) a 1750 RPM

Alturas de elevación:

400 pies THD (120 m) a 3500 RPM,
100 pies THD (32 m) a 1750 RPM

Presión de trabajo máxima:

175 PSI (12 baras)

Temperatura máxima:

212°F (100°C) con sello estándar o
250°F (121°C) con sello opcional
para alta temperatura.

Materiales de construcción:

Impulsores – Ac. Inox. 316L

Los tamaños de 22/23/27/28 tienen impulsores de hierro fundido.

Carcasa y caja del sello – hierro fundido

Rotación: En el sentido de las agujas del reloj visto desde el extremo del motor.

Impulsor encerrado y anillo de desgaste reemplazable:

para alta eficiencia y máxima durabilidad.

Motor (acoplamiento compacto):

Eje abierto a prueba de goteo JP estándar NEMA, totalmente encerrado y recintos a prueba de explosión, 60 Hz, 1750 ó 3500 RPM.

Monofásicos

ODP/TEFC/EXP. (115/230 V)
1750 RPM, ½ – 10 HP.
3500 RPM, ½ – 10 HP.

Trifásicos ODP/TEFC/EXP.
(208 – 230/460 V).

1750 RPM, ½ – 30 HP
3500 RPM, ½ – 75 HP

NOTA: Se debe de proporcionar protección térmica contra sobrecarga. Contactor con protección térmica contra sobrecarga para monofásicos o arrancadores con calentadores para trifásicos se piden por separado.