

---

# AQUAVAR<sup>®</sup> Model 56 Controller



Variable Speed  
Pump Control

Installation Programming & Operation

Models Covered:

04168001

04168001WM

04168231

04168231WM

04168241

04168241WM

Software – CP-V00:004

# AQUAVAR Model 56 Controller Owner's Information Record

Aquavar Model 56 Controller \_\_\_\_\_ Pump Code Number \_\_\_\_\_  
 S/N \_\_\_\_\_ Transducer Model \_\_\_\_\_  
 Date Purchased \_\_\_\_\_ Transducer Rating \_\_\_\_\_  
 Purchased From \_\_\_\_\_

## Program Record





Parameter	Range (Default)	User Setting
Actual Pressure	N/A	Read-Only
Set Pressure	0-150 psi (45 psi)	
Submenu Parameter	N/A	Read-Only
Password	(66)	Read-Only
Submenu Diagnostics	N/A	Read-Only
Motor Hours	N/A	Read-Only
S10 Address	N/A	Read-Only
Error	N/A	Read-Only
Overload Error	N/A	Read-Only
OverVolt Error	N/A	Read-Only
Software Version	N/A	Read-Only
Change Pressure	Disable (Enable)	
Autostart	Disable (Enable)	
Mode	Actuator, (Controller), Multicontroller	
Regulation Mode	(Normal), Inverse	
Dimension Unit	(psi), bar, %	
Submenu Inverter	N/A	Read-Only
Maximum Frequency	6-60 Hz (60 Hz)	
Minimum Frequency	0-60 Hz (0 Hz)	
Boost	0-25% (5%)	
Configuration – Minimum Frequency	Fmin (F = 0)	
Submenu Control	N/A	Read-Only
Window	0-100% (15%)	
Hysteresis	0-100% (80%)	
Acceleration High	1.0-999.9 (4 sec.)	
Deceleration High	1.0-999.9 (4 sec.)	
Acceleration Low	1.0-999.9 (70 sec.)	
Deceleration Low	1.0-999.9 (70 sec.)	
Lift Frequency	6-60 Hz (30 Hz)	
Lift Intensity	0-100% (0%)	

# AQUAVAR Model 56 Controller Owner's Information Record

## Program Record (continued)

Parameter	Range (Default)	User Setting
Submenu Multicontrol	N/A	Read-Only
Actual Value Increase	0-100% (6%)	
Actual Value Decrease	0-100% (4%)	
Enable Sequence Control	6-60 Hz (60 Hz)	
Switch Interval	0-250 (12 Hrs)	
Submenu Slave Pump		
Slave Pump Configuration	Simple Multi Control, Run Signaling or Error Signaling	
Slave On	0-60 Hz (58 Hz)	
Slave Off	0-60 Hz (0 Hz)	
Submenu Sensor		Read-Only
Sensor ZeroAdjust	Press (INC) + (DEC)	
Sensor Adjust Maximum	0.5-4.5 V	
Submenu Test Run		Read-Only
Test Run Start	Press (INC) + (DEC)	
Test Time	10-100 hrs (0 hrs)	
Test Frequency	0-60 Hz (30 Hz)	
Test Run Boost	0-25% (5%)	
Submenu Error		Read-Only
Conveyor Limit	0-100% (0%)	
Error Delay	0-100 Secs (0 Secs)	
Set Password	0-9999 (66)	
Default Settings		

## Index

System Design .....	1
 Important Safety Instructions .....	2
 Installation Procedures .....	4
1) Materials Checklist .....	4
2) Mounting the Aquavar Model 56 Controller .....	5
3) Electrical Connections .....	7
4) Pump Priming .....	10
5) Run Test .....	10
 Programming .....	13
1) Single Pump – Constant Pressure .....	13
2) Single Pump – Pump Protection .....	13
• To Set Run Out Protection .....	14
3) Single Pump – System Curve Compensation .....	17
4) Circulator Applications .....	20
5) Multiple Pump – Constant Pressure or System Curve Compensation .....	20
6) Slave Pump – Constant Pressure .....	23
 Operator Custom Features and Displays .....	27
• Actual Pressure .....	27
• Set Pressure .....	27
• Submenu Parameter .....	27
• Password .....	27
• Change Pressure .....	27
• Autostart .....	27
• Mode .....	28
• Regulation Mode .....	28
• Dimension Unit .....	28
• Submenu Inverter .....	28
• Max. Frequency .....	28
• Min. Frequency .....	28
• Boost .....	29
• Config. F Min. .....	29
• F Min. Time .....	29
• Submenu Controller .....	29
• Window .....	29
• Hysteresis .....	30
• Acceleration High .....	30
• Deceleration High .....	30
• Acceleration Low .....	30
• Deceleration Low .....	30
• Lift Frequency .....	31



## Operator Custom Features and Displays (continued)

• Lift Intensity .....	31
• Submenu Controller .....	31
• Actual Value Increase .....	32
• Actual Value Decrease .....	32
• Enable Sequence Control .....	33
• Switch Interval .....	33
• Submenu Relay .....	33
• Relay Configuration .....	33
• Slave On Limit .....	33
• Slave Off Limit .....	33
• Submenu Sensor .....	34
• Sensor Adjust .....	34
• SensorMax – Adjust .....	34
• Submenu Test Run .....	34
• Start Test Run .....	34
• Time Test Run .....	34
• Test Frequency .....	34
• Boost Test Run .....	34
• Submenu Error .....	35
• Conveyor Limit .....	35
• Error Delay .....	35
• Set Password .....	35
• Default .....	35
• Submenu Diagnosis .....	35
• Pump Runtime .....	35
• Pump Address .....	35
• Last Error .....	36
• Software Version .....	36
• Set Password .....	36



## Repair of Faults and Errors .....

• Low Water .....	37
• Overheating – Motor .....	37
• Overvoltage .....	37
• Undervoltage .....	38
• Overheating – Heatsink .....	38
• Overload .....	38
• Pressure Sensor .....	38
• Conveyor Limit .....	38
• Error 1-8 .....	38

## Appendix A – Pressure Transducer Data .....

## Appendix B – AQUAVAR Model 56 Controller Drive Head Technical Data .....

## System Design

### Note

Systems **MUST** be designed by qualified technicians only.

The following diagrams show typical single pump and multi-pump systems using the AQUAVAR Model 56 Controller. Connection can be made directly to a water supply or water can be drawn from a supply tank or well. In the case of supply tanks and wells, level switches, **(item 10)** can be used to shut down the pumps when water is low. In the direct connection, a pressure switch on the suction side **(item 8)** can be used.

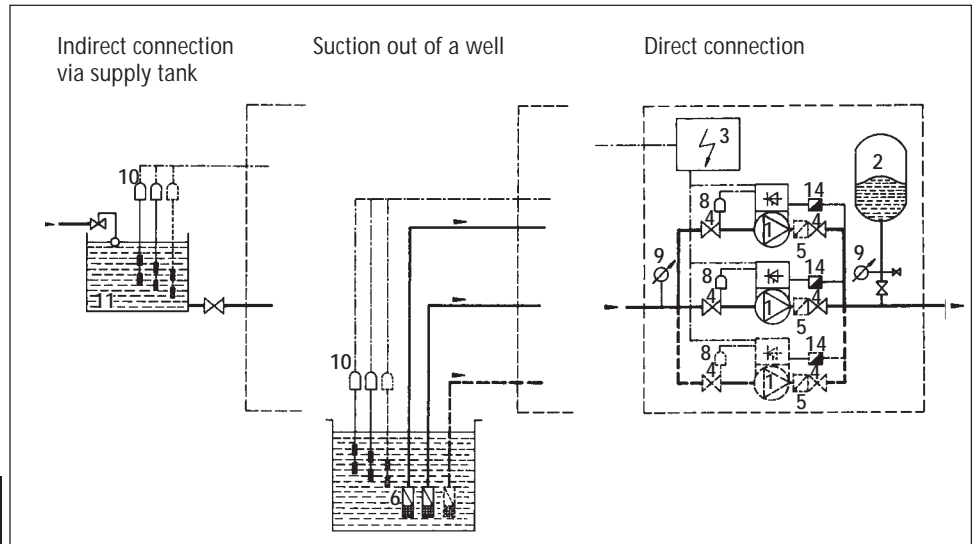

Diagram 1  
Multiple Pump Layout

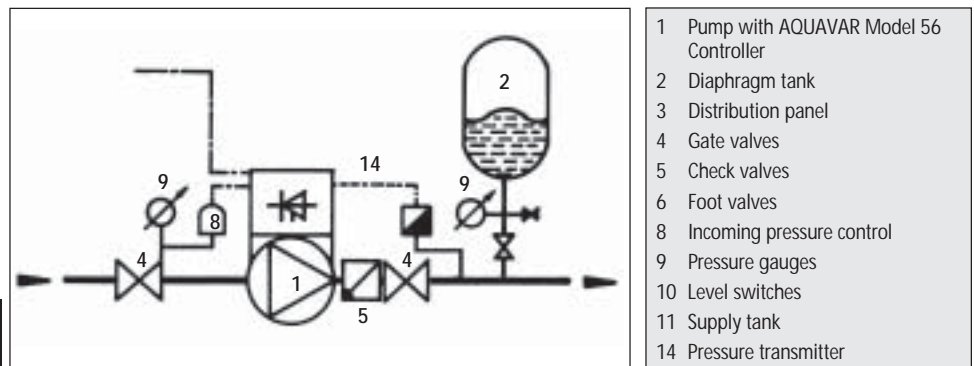

Diagram 2  
Single Pump Layout

- 1 Pump with AQUAVAR Model 56 Controller
- 2 Diaphragm tank
- 3 Distribution panel
- 4 Gate valves
- 5 Check valves
- 6 Foot valves
- 8 Incoming pressure control
- 9 Pressure gauges
- 10 Level switches
- 11 Supply tank
- 14 Pressure transmitter

A diaphragm pressure tank is used on the discharge side of the pump or pumps to maintain pressure in the line when there is no demand. This will keep the pumps from continuing to run. With the AQUAVAR Model 56 Controller, it is not necessary to have a large tank for supply purposes. In selecting a tank, make sure it can withstand system pressure. The tank should have a capacity of about 10% of the maximum single pump flow rate in gpm. Pre-charge the tank to the following:

PSI Set Pressure	15	30	45	60	75	90	105	120	135	150
PSI Tank Pre-charge	12	21	37	52	64	77	95	110	125	138

### Note

Closed loop circulator systems may not require a pressure tank.

# ! Safety Instructions



**Important: Read all safety information prior to installation of the AQUAVAR Model 56 Controller.**

## Note



This is a **SAFETY ALERT SYMBOL**. When you see this symbol on the pump or in the manual, look for one of the following signal words and be alert to the potential for personal injury or property damage.



**DANGER** Warns of hazards that **WILL** cause serious personal injury, death, or major property damage.



**WARNING** Warns of hazards that **CAN** cause serious personal injury, death, or major property damage.



**CAUTION** Warns of hazards that **CAN** cause personal injury or property damage.

**NOTICE** Indicates special instructions which are very important and must be followed.

1. This manual is intended to assist in the installation, operation, and repair of the AQUAVAR Model 56 Controller and must be kept with the AQUAVAR Model 56 Controller.

## Note

All operating instructions must be read, understood, and followed by the operating personnel. Goulds Pumps accepts no liability for damages or operating disorders which are the result of non-compliance with the operating instructions.

2. To avoid serious or fatal personnel injury or major property damage, read and follow all safety instructions in this manual.

# ! Safety Instructions

## Safety Instructions

3. Installation and maintenance **MUST** be performed by properly trained and qualified personnel.
4. Review all instructions and warnings prior to performing any work on the AQUAVAR Model 56 Controller.
5. Any safety decals **MUST** be left on the AQUAVAR Model 56 Controller unit and pump.

### Note

Inspect AQUAVAR Model 56 Controller for any damage after unpacking from shipping crates. Report any damage immediately to the carrier or distributor/dealer immediately.

6. In addition to instructions contained in this manual, you must meet any local safety, electrical, or plumbing codes and requirements. Installation, maintenance, or repair work must only be carried out by trained, skilled, and qualified personnel.
7. **The AQUAVAR Model 56 Controller drive head must be disconnected from the main power supply before attempting any operation in the electrical or mechanical part of the system.**

### Note

When in operation, the motor can be stopped, but power remains at the drive head. The motor and pump could start unexpectedly and produce serious injury. When the AQUAVAR Model 56 Controller drive head is connected to the main power supply, the inverter power supply and master control unit are also connected to the power supply.



### WARNING!

**FAILURE TO DISCONNECT ELECTRICAL POWER BEFORE ATTEMPTING ANY MAINTENANCE CAN CAUSE SHOCK, BURNS, OR DEATH.**

# Installation Procedures

Electrical Connections continued

## Step 1 - Identify Materials

The following materials are provided with the AQUAVAR Model 56 Controller. Please familiarize yourself with each prior to installation.

PART	QUANTITY	PART	QUANTITY
1) AQUAVAR Model 56 Controller	1	6) 3/8" NPT Cord Grip	2
2) Washer (AV 1.1)	1	7) 3/8" NPT Plug	1
3) Mounting Bolt (AV 1.1)	1	8) Conduit Plate (two types)	1
4) Thermistor	1	9) Gasket	1
5) 1/2" NPT Liquid Tight Connector	3	10) Cover	1
		11) Mounting Clamps (AV 1.15, 2.2)	4

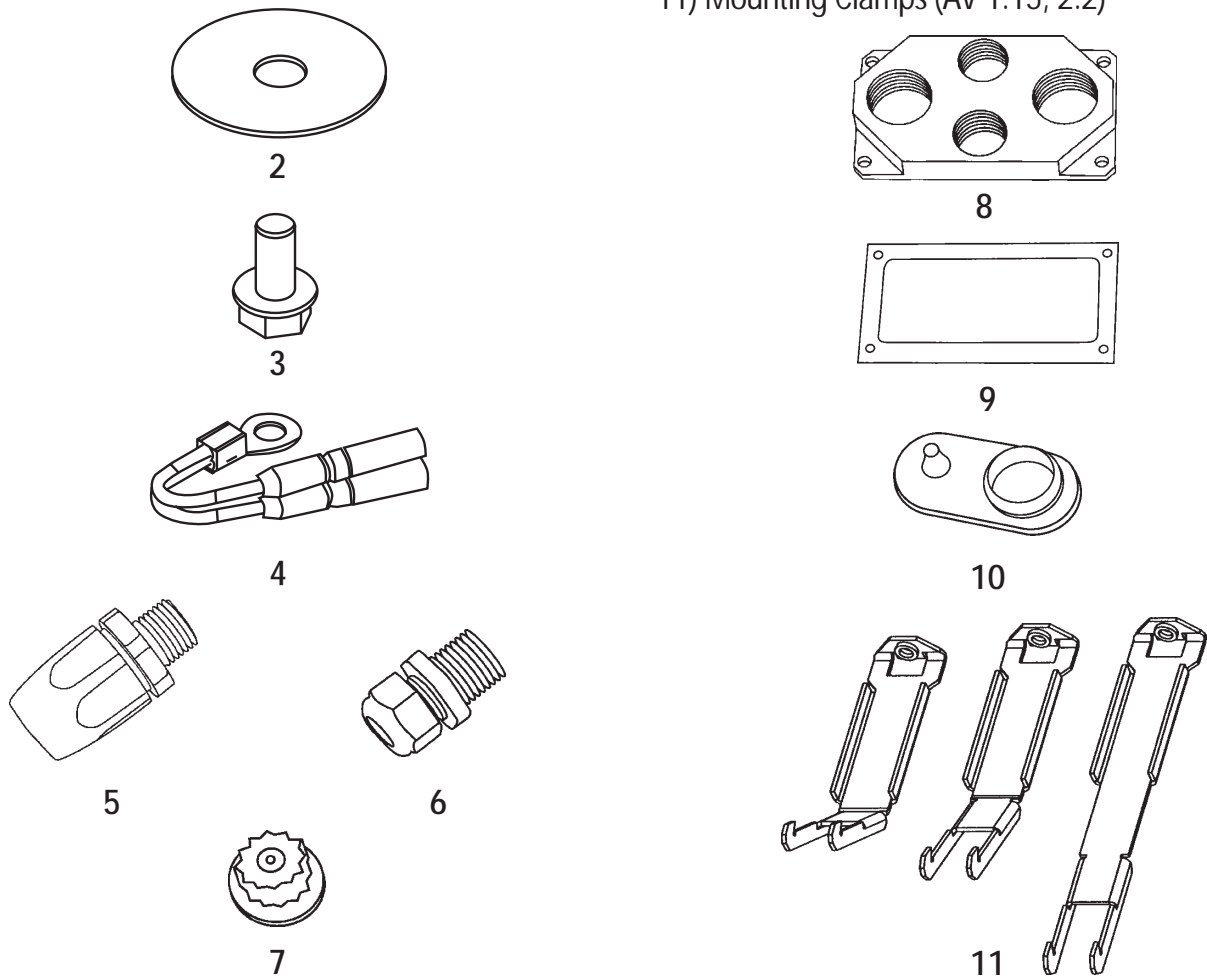

Diagram 3

# Installation Procedures

## Step 2 – Mounting the AQUAVAR Model 56 Controller (AV 1.1 style)

- 1) The AQUAVAR Model 56 Controller drive head is supplied with electrical connectors and mounting hardware.
  - Remove the motor fan cover from your three phase TEFC motor by removing the fan cover screws.
  - Obtain the fan cover (5) and the AQUAVAR Model 56 Controller (1) and attach them together with the mounting bolt (4) and washer (3).
  - Use the fan cover screws to mount the fan cover/AQUAVAR Model 56 Controller combination to the motor.

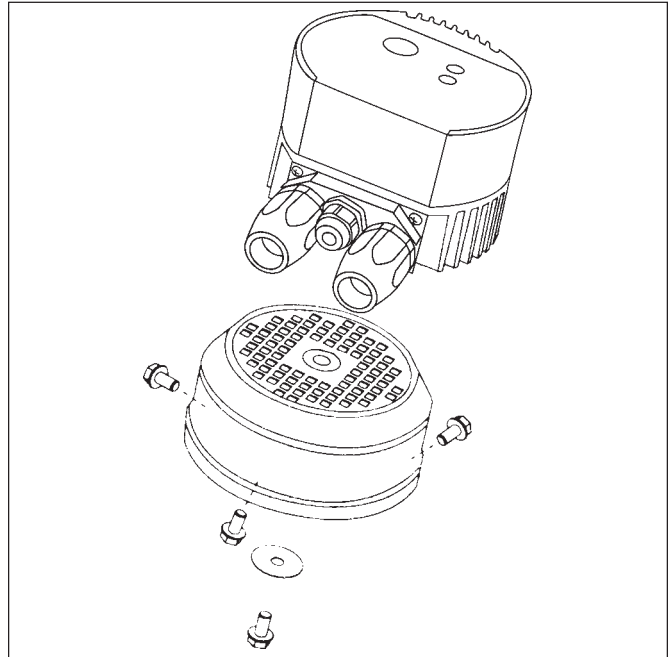

Diagram 4

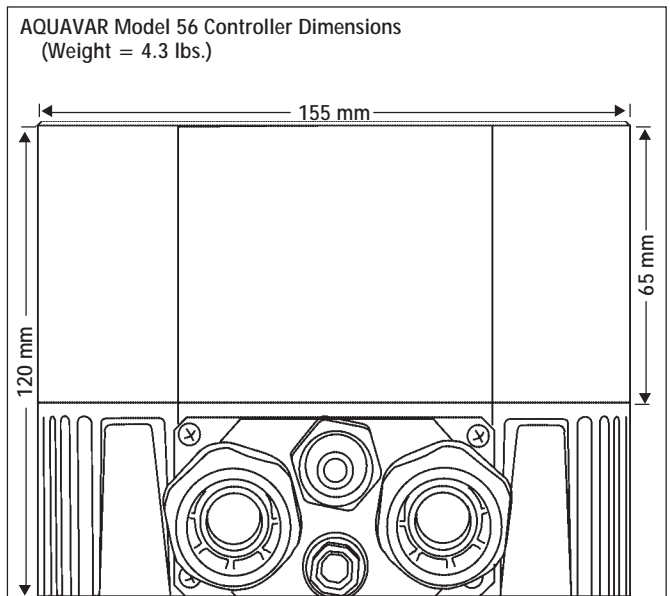
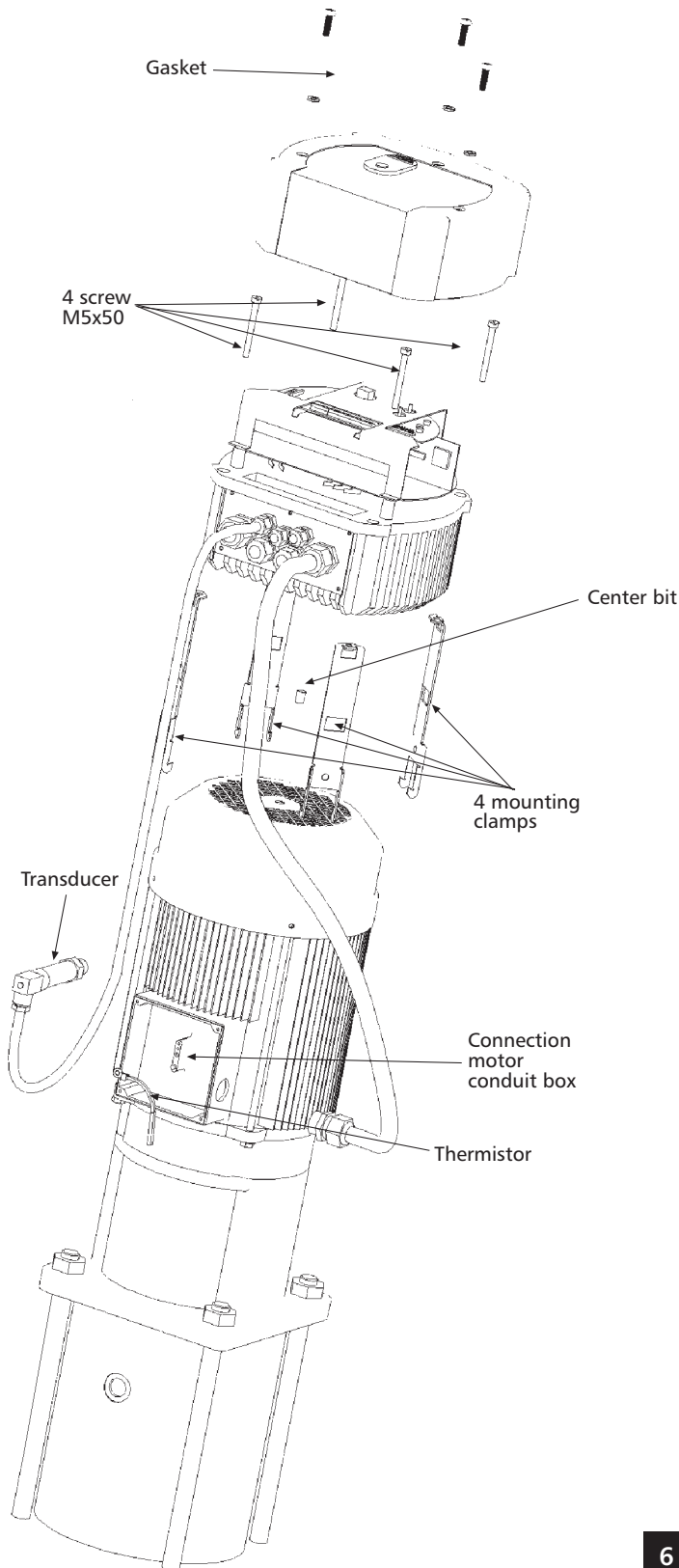

Diagram 5

# Installation Procedures

## Step 2 – Mounting the AQUAVAR Model 56 Controller (AV 1.15, AV 2.2 style) *continued*



### 2) Mounting:

- Remove the 3 screws from the AQUAVAR cover.
- Place the center bit in the AQUAVAR heat sink.
- Place the AQUAVAR on the motor.
- Hang the 4 clamps by the motor fan cover and mount with the 4 screws to the AQUAVAR.
- Replace the AQUAVAR cover with the 3 screws.

Type	Weight (kg)
AV 1.15	4.70
AV 1.2	4.70

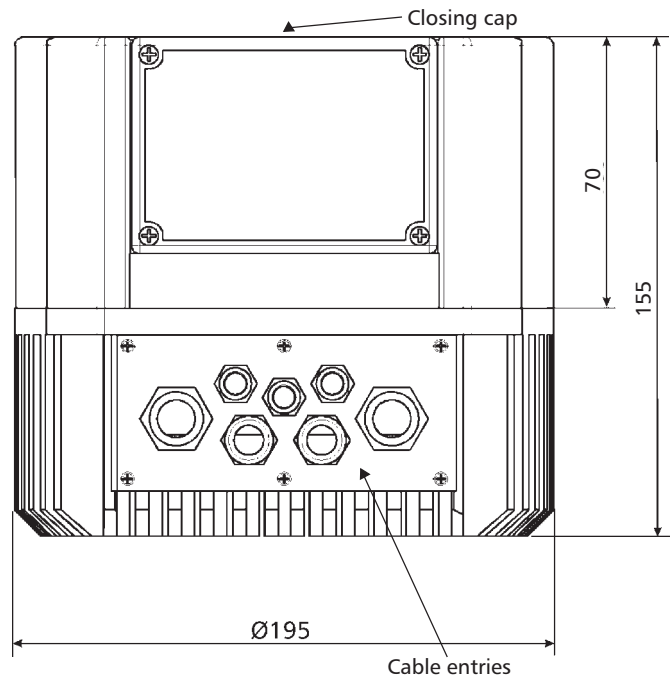

Don't forget the gaskets for the 3 screws. Ensure that there is no water on the unit before you open the cover.

## Electrical Connections



### WARNING!



FAILURE TO DISCONNECT AND LOCKOUT ELECTRICAL POWER AND WAIT FIVE MINUTES FOR CAPACITOR DISCHARGE BEFORE SERVICING AQUAVAR MODEL 56 CONTROLLER CAN CAUSE SHOCK, BURNS, OR DEATH.

### Note

Installation and maintenance must only be performed by properly trained and qualified personnel equipped with the proper tools.



### WARNING!

-  INSTALL, GROUND, AND WIRE ACCORDING TO LOCAL AND NATIONAL ELECTRICAL CODE REQUIREMENTS.
-  INSTALL AN ALL LEG DISCONNECT SWITCH NEAR THE MOTOR.
-  DISCONNECT AND LOCKOUT ELECTRICAL POWER BEFORE INSTALLING OR SERVICING.

ELECTRICAL SUPPLY MUST MATCH PUMP'S AND AQUAVAR MODEL 56 CONTROLLER NAMEPLATE SPECIFICATIONS. INCORRECT VOLTAGE OR WIRING CAN CAUSE FIRE DAMAGE, AND VOIDS WARRANTY.

MOTORS WITH AUTOMATIC THERMAL PROTECTION MAY OPEN THEIR ELECTRICAL CIRCUIT WHEN A THERMAL OVERLOAD EXISTS. THIS CAN CAUSE THE MOTOR TO START UNEXPECTEDLY AND WITHOUT WARNING.

# Installation Procedures

## Step 3 – Wiring the AQUAVAR Model 56 Controller to the motor

(Parts in the electrical fittings package will be required for this procedure). Refer to diagrams 6 and 7 before proceeding.

- 1) Remove the 3 screws holding the top of the AQUAVAR Model 56 Controller. Carefully lift off the top, disconnect the groundwire and set aside.
- 2) **Motor Lead Connections:** Locate the terminals U, V, W and GRD #1 inside the AQUAVAR Model 56 Controller. Connect wires to the terminals and route the cable as shown on diagram 7.

- 3) **Connections in Conduit Box:** The free end of the motor cable should now be routed through the strain relief on the conduit box. Connect the motor leads using the motor nameplate as reference.

Place the thermistor terminal in the conduit box and fasten so that the sensor will contact the motor shell. Connect the thermistor with 2 wires routed to locations X2 #9 and X2 #8.

- 4) **Pressure Transducer Installation and Wiring:** Locate the pressure transducer and cable. The threaded end of the transducer is a 1/4" NPT. Install the transducer in the discharge pipe on the downstream side of the check valve and connect the cable. Now select one of the remaining holes in the plate on the AQUAVAR Model 56 Controller heat sink. Route the cable through the o-ring and fasten. Cut to length and connect to locations X2 #1, X2 #2, X2 #3. See diagram 6 for reference.

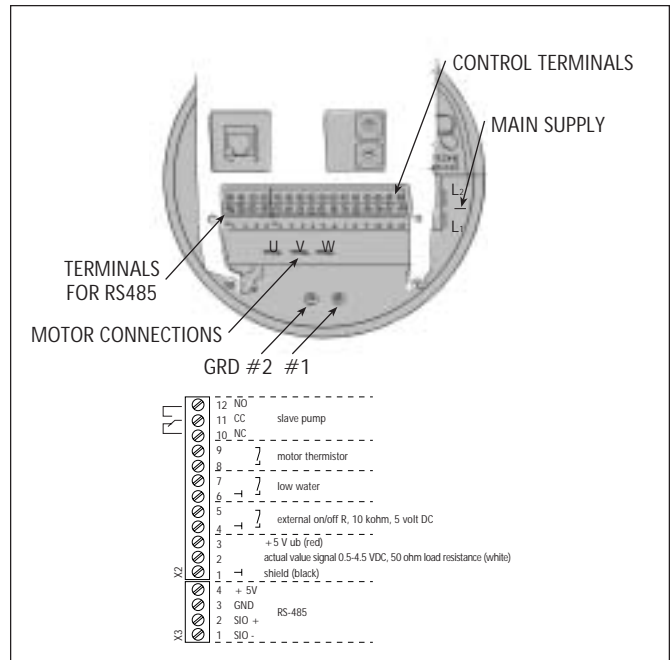

Diagram 6

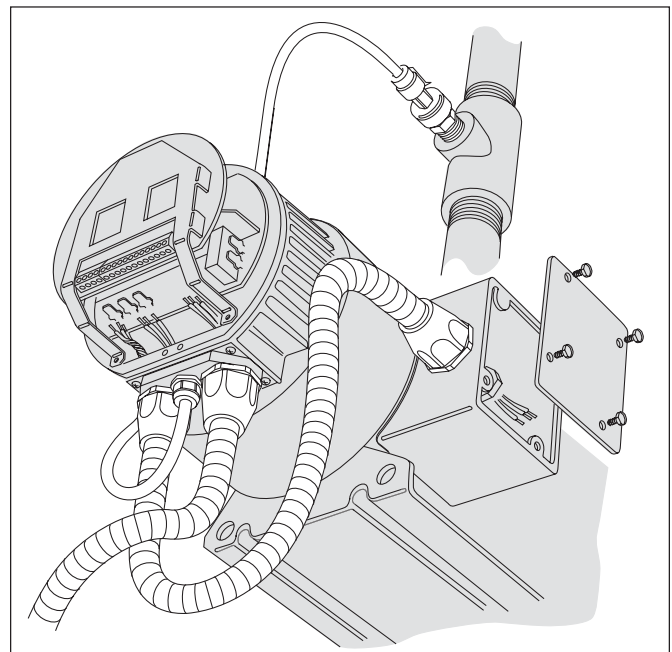
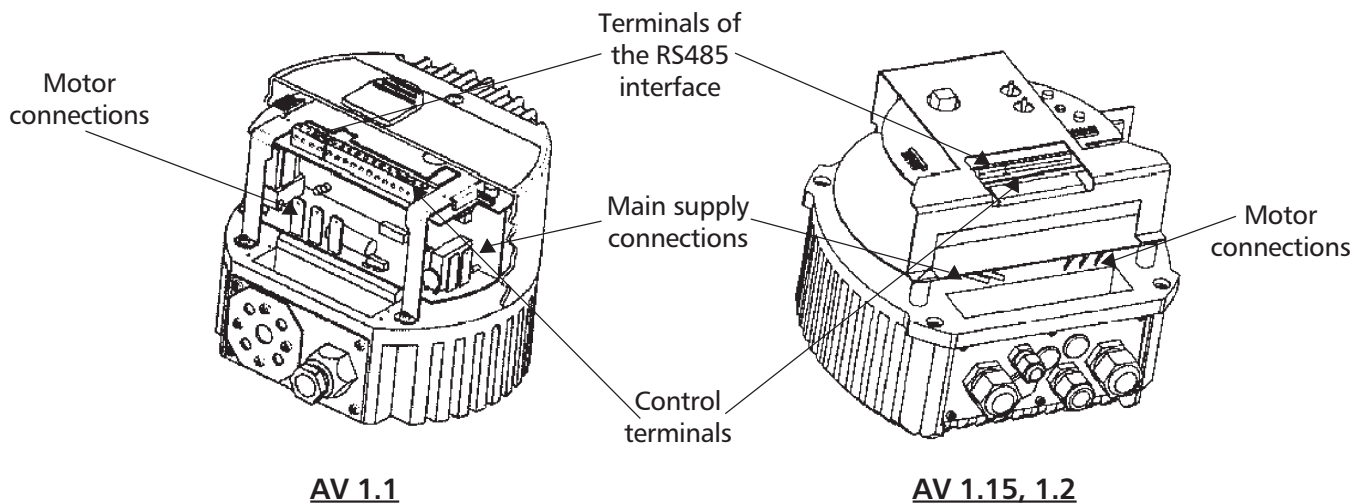

Diagram 7

# Installation Procedures

## Electrical Connections continued

- 5) **Input Power Cable Installation:** The main power cable is connected to GRD #2, L1, L2 for 230 Volt single phase.
  - Route the cable through the strain relief per diagram #7, cut to length and connect.
  - See Appendix B for protection requirements.
- 6) For Multi-Pump Systems: Use a three core shielded cable to connect terminals X3/1, X3/2 and X3/3 between the AQUAVAR Model 56 Controller units. These are the RS-485 interface connections. (See diagram 6 and 8). Shielding may be grounded on terminal X3/3.
- 7) **Low Water Switch:** Used to indicate low water, connect to terminals X2/6 and X2/7. Refer to diagram 6. **Jump terminals if not used.**
- 8) **External On/Off:** Used to turn the AQUAVAR Model 56 Controller on/off from an external panel or controller, connect to X2/5 and X2/4. Refer to diagram 6. **Jump terminals if not used.**
- 9) **Relay:** This connection may be used to turn on/off a full speed slave pump or an external run or error indicator. Wire the relay to the switch controlling the device selected. (X2/10, X2/11, and X2/12)



# Installation Procedures

## Pump Priming

Refer to your pump operation manual for instructions on pump priming.

## Run Test

### WARNING

DO NOT APPLY POWER TO THE AQUAVAR MODEL 56 CONTROLLER OR PUMP UNTIL ELECTRICAL CONNECTIONS HAVE BEEN REVIEWED BY A QUALIFIED ELECTRICIAN AND MEET ALL APPLICABLE STATE AND LOCAL REQUIREMENTS.

## Instructions

- 1) **Check all wiring.** All motors used with the AQUAVAR Model 56 Controller are three phase TEFC (a wall mounted version permits the use of other enclosures). You will need to check the direction of rotation of the motor shaft. If you have followed all of the previous steps carefully, you should now be ready to apply power to the AQUAVAR Model 56 Controller unit.
- 2) **Close discharge valve.** Make sure the discharge valve is closed. **Apply power to the AQUAVAR Model 56 Controller.**
- 3) The next step is to apply power to the AQUAVAR Model 56 Controller and check for proper rotation of the motor. The first start up of the AQUAVAR Model 56 Controller should be done with the external programming device. If you operate the AQUAVAR Model 56 Controller without the programming device, the following parameters have to be set in the submenu (see operation in the main menu).
  - ◆ Change pressure: ENABLED
  - ◆ Autostart: ENABLED

The AQUAVAR Model 56 Controller is delivered with these settings as standard.



### Screen

—

—

NO AUTOSTART – DISABLE INVERTER

## Change Pressure without Remote Control

- 1) Start the pump with the push button  on the front plate of the AQUAVAR Model 56 Controller.
- 2) Then press the  and  buttons together for more than 3 seconds.

# Installation Procedures

## Change Pressure without Remote Control (continued)

- 3) The LED color changes to orange.
- 4) Now you could change the pressure with the ▲ and ▼ buttons. The set pressure is read off a gauge on the pump discharge.
- 5) If there is no change to the setting for more than 5 seconds, the AQUAVAR Model 56 Controller returns to normal operation automatically, and the new required pressure is stored.
- 6) The pump can only be STARTED with the ▲ button or STOPPED with the ▼ button. Both buttons are on the front plate of the AQUAVAR Model 56 Controller.

If the direction of rotation was not correct, remove all power from the AQUAVAR Model 56 Controller and wait 5 minutes. Open the motor conduit box and exchange any two of the three motor leads. Close the conduit box.

Repeat the above steps.

## LED description

**Orange Solid** – The external programming device is connected. Required pressure can be changed with the buttons ▲ and ▼.

**Orange Fast Flashing** – Connected remote control and the pump is running.

**Orange Slow Flashing** – Connected remote control the inverter is on and the pump is stopped because required pressure is reached.

**Green Solid** – Motor is not running. (Open external stop with terminals X2/4; X2/5 or the item is stopped with the ▼ button on the front plate.

**Green Slow Flashing** – Inverter is active, but the motor has stopped.

**Green Fast Flashing** – Motor is running.

**Red Solid** – Error.

**Red Flashing** – Fatal error (AQUAVAR Model 56 Controller has to be disconnected from the power supply).

## General Instructions for working with the external programming device.

With the ← and → keys you can select the different parameter windows in the menu. To enter a submenu press the ▼ button. To leave the submenu, press and hold the → or the ← for more than 3 seconds.

Each change in the settings are stored after leaving this parameter window with the ← or →. During saving "SAVE PARAMETER" is shown on the display of the programming device for a short time.

## Connecting the External Programming Device to the AQUAVAR Model 56 Controller

After connection of the AQUAVAR Model 56 Controller to the power supply and attachment of the external programming device, one of two different messages will be shown:

- 1) If the **AUTOCONNECTION** is disabled (standard) you see:

- This message is shown, when the Remote Control is first connected. At this time the AQUAVAR Model 56 Controller searches for an available address.
- If address 01 is available, the display changes to:  
The actual pump address is shown.
- If the actual pump address 01 is not available the display does not change and you will see again:  
Then you could change the address with **↓** and **↑** and confirm the selected address with **→**.



When you are connected to a system with more than one pump, connected together over the interface, you can select with **↓** and **↑**, the address of the pump you want to talk to and confirm the selected address with **→**. Status information is shown as follows:

P1:	Masterpump
P2:	Slavepump
P3:	Slavepump
P4:	Slavepump
P:	Number is not used
Hold:	Pump stops through the pressure transmitter
Run:	Pump runs
Stop:	Pump stops through the lead pump
Disabled:	Pump stops through the stop button or the terminal block
Error:	Pump stops through an error

# Programming

Press → on the controller and you enter the **INVERTERMENU**

2) If the **AUTOCONNECTION** is enabled, the following message is shown:

- This message is shown during the connection, when **AUTOCONNECTING** is enabled. In this time the **AQUAVAR Model 56** Controller searches for the given or entered address.
- Then the display changes to the first display. The actual input value (%) and the actual output frequency (Hz) are displayed.

SCAN  
CONNECTION

PRESS X.X%  
SPEED X.X Hz

## I. The Main Menu – Setting Single Pump Constant Pressure (Flowchart #1)

On the first startup of the Aquavar Model 56 Controller with the external programmer the “Change Pressure” and “Autostart” are enabled. After connecting, the display on the remote control reads.

This message is shown when the Remote Control is attached to the **AQUAVAR Model 56** Controller.

SCAN CONNECTION

After a few seconds the display changes automatically to:

PRESSURE X.X psi  
SPEED X.X Hz

This shows the actual values for pressure and speed. Press → on the controller to change to:

PRESSURE XX.X psi

To change the pressure use the ↑ and ↓ buttons. If you have changed the value you will get the message “**SAVE PARAMETER**” for a short time. Press → on the controller to return to the actual value display.

## II. Single Pump – Pump Protection (Flowchart #2)

The **AQUAVAR Model 56** Controller has the ability to protect the pump by shutting it off in low/no suction or run out conditions.

### Note

Low/no suction protection depends on the installation of a suction line pressure switch, or float switch for a tank. This switch is connected to the **AQUAVAR Model 56** Controller as described earlier in the Electrical Installation section. The cut off setting for this switch should be the maximum **NPSH** required by the pump.

# Programming

To set run out protection:

## Note

Run out protection occurs if the pump is running at full speed, and the set pressure cannot be recorded after a set period of time. To set run out protection you need to enter the amount of pressure drop and the time delay.

## Instructions

- 1) **Password** The password protection prevents untrained personnel from accidentally changing the base setting.
  - From the **(parameter)** screen on the main menu press the **↓** arrow until the display changes to:
- 2) Press the **↑** arrow until you reach the number 0066.
- 3) Press the **→** arrow repeatedly until you reach:
- 4) Press the **↓** arrow once and you will reach:
- 5) By pressing the **↑** arrow. Enter the pressure setting (in psi) at which you want the pump to shutoff. Typically a setting of 3 to 5 psi less than the standard pressure setting would be entered.
- 6) Now press the **→** arrow and you will reach:
- 7) By pressing the **↑** arrow you will be entering the amount of time (in seconds) that the pump will run at the pressure setting programmed into the conveyor limit before it automatically shuts off. Returning to normal operation:
- 8) Hold the **→** arrow down for 3 seconds and you will be returned to:
- 9) Hold the **→** arrow down again for 3 seconds and you will be returned to: The Main Menu.

PASSWORD  
0000

PASSWORD  
0066

SUBMENU  
ERROR

CONVEYOR LIMIT  
0.0 PSI

CONVEYOR LIMIT  
25 PSI

ERROR DELAY  
0S

ERROR DELAY  
5S

SUBMENU  
ERROR

PRESSURE 00 PSI  
SPEED 00HZ

# Programming

## Single Pump – Constant Pressure (Flowchart #1)

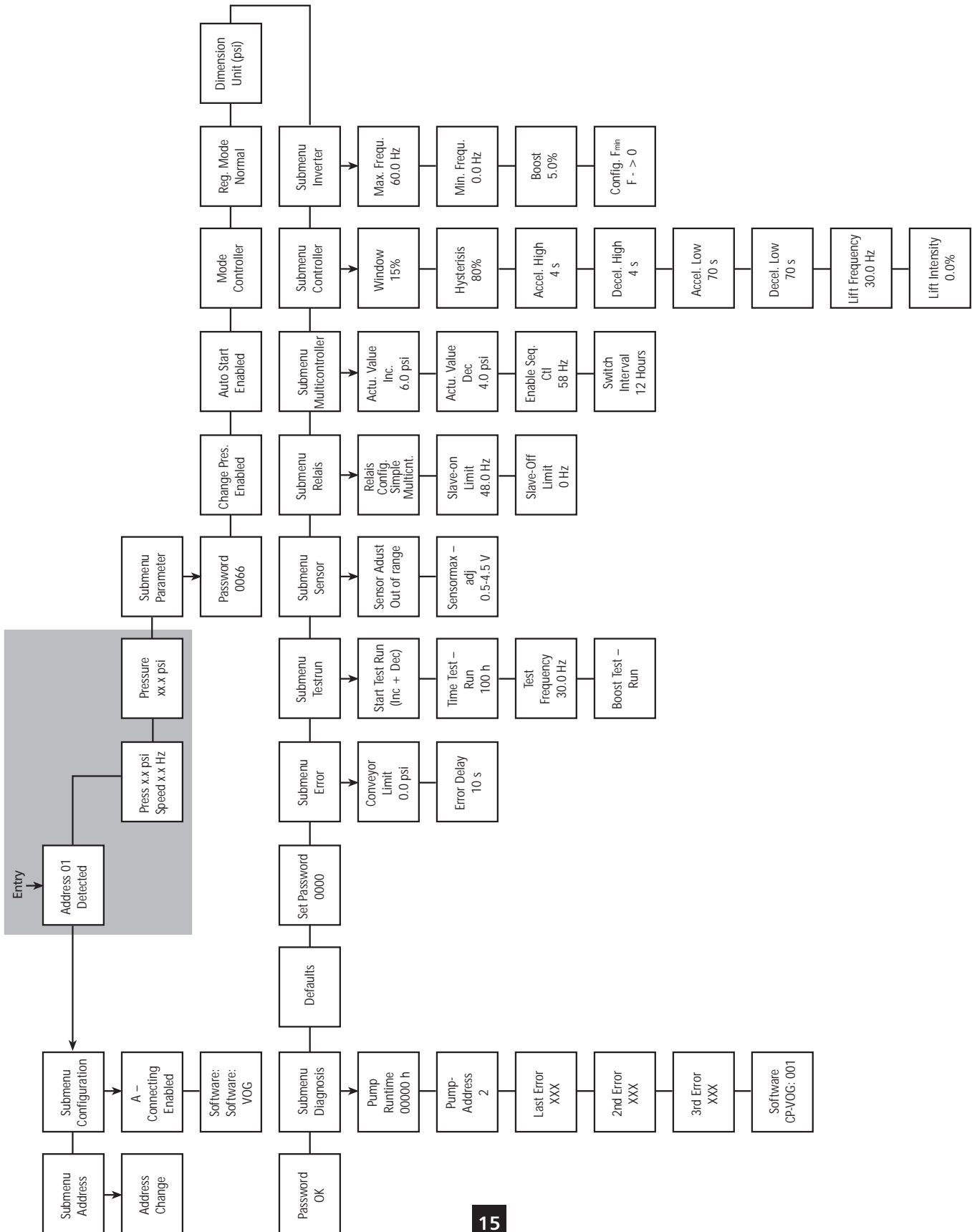

# Programming

## Single Pump – Pump Protection (Flowchart #2)

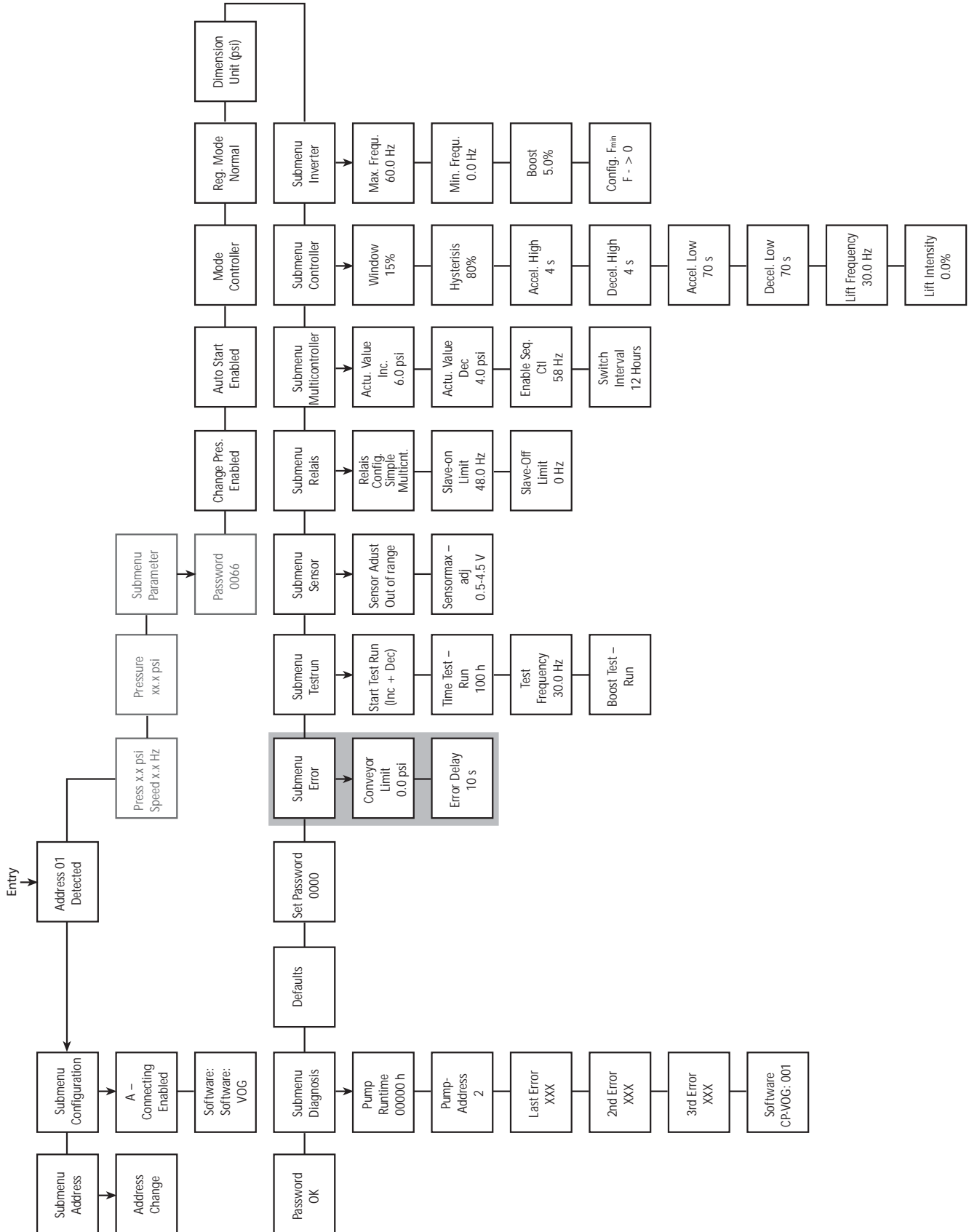

## III. Single Pump – System Curve Compensation (Flowchart #3)

The AQUAVAR Model 56 Controller can automatically compensate for system friction losses due to increased flow. Tables are available in most pump catalogs (including the G&L Pumps catalog) indicating the amount of friction loss that can be expected in various sizes of pumps at different flow rates. Use these tables to **determine the friction loss for the pipe size you are using at your maximum flow rate.**

Diagram 8 shows a typical system curve. The system pressure set point is shown at shut-off and the pressure increase is shown for increasing flow.

**Calculate the pressure increase required to overcome friction loss at maximum flow as a percent of the set point.**

For example, if your required system pressure is 30 psi and it takes an additional 3 psi for friction loss at maximum flow, the percent increase is 10%.

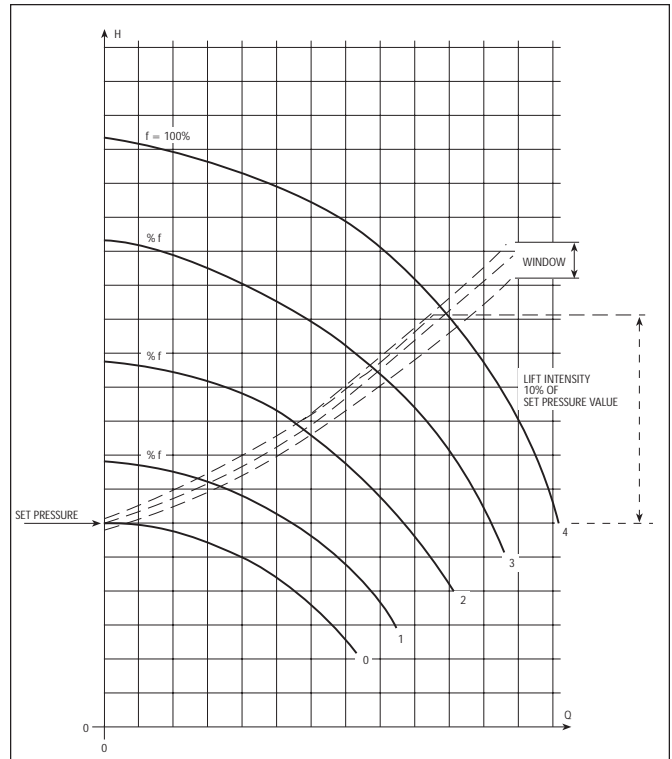

Diagram 8

## Entering Compensation Values

### Instructions

- 1) From the **Parameter** screen on the main menu press the **↓** arrow and the display changes to:
- 2) Press the **↑** arrow until you reach the number 0066.
- 3) Press the **→** arrow repeatedly until you reach:
- 4) Press the **↓** arrow once and you will reach:
- 5) Press the **→** arrow several times until you reach:
- 6) Now press the **↑** arrow until you reach the desired "Lift Frequency". This is the frequency at which the pump works at the set pressure and a flow of 0 GPM. On a 60 Hz system, there is virtually no flow below 40 Hz.
- 7) Use the **→** arrow to move to the screen:
- 8) Now press the **↑** arrow until you reach the desired "Lift Intensity". This value states how much the set value should be continually increased until the maximum speed is reached.

### Returning to normal operation:

- 9) Hold the **→** arrow down for 3 seconds and you will be returned to:
- 10) Hold the **→** arrow down again and you will be returned to the main menu.

PASSWORD  
0000

PASSWORD  
0066

SUBMENU  
CONTROLLER

WINDOW  
0.0%

LIFT FREQUENCY  
6 Hz

LIFT FREQUENCY  
40 Hz

LIFT INTENSITY  
0%

LIFT INTENSITY  
3%

SUBMENU  
CONTROLLER

PRESSURE 00 PSI  
SPEED 00HZ

# Programming

## System Curve Compensation (Flowchart #3)

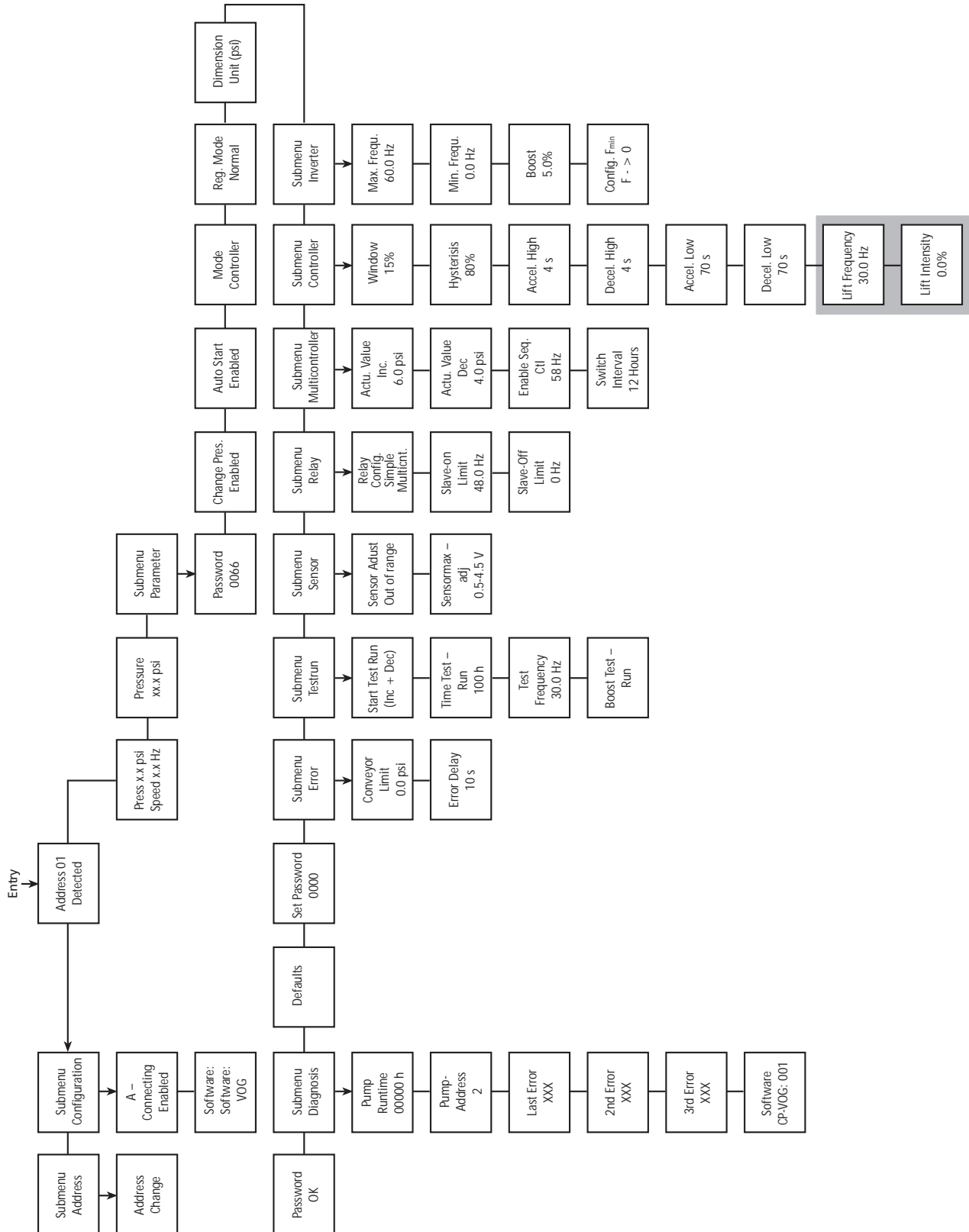

## IV. Circulator Applications

On circulator pumps, the system curve can be automatically tracked through the use of a differential pressure transducer. This pressure transducer reads the outgoing discharge pressure and the incoming return pressure and compensates for differences in pressure as demand and speed increase. Programming is the same as just covered for the single transducer version. Data on the differential pressure transducer can be found in Appendix A.

## V. Multiple Pump Constant Pressure System Curve Compensation (Flowchart #4)

When two, three or four AQUAVAR Model 56 Controller controlled pumps are connected in a system, they can be programmed to work together to maintain system pressure up to the maximum flow rate of all the pumps combined. As the first pump reaches its maximum speed and flow, the second pump will automatically turn on (and so on). In addition, the sequence of the pump that will run first (lead pump) can be automatically varied to reduce premature wear on any one pump in the system.

1) Refer to the section "The Main Menu - Setting One Pump Constant Pressure". Follow the step then continue below.

### Instructions

- 2) From the **Parameter** screen on the main menu press the ▼ arrow until the display changes to:
- 3) Press the ▲ arrow until you reach the number 0066
- 4) Press the → arrow repeatedly until you reach:
- 5) Press the ▼ arrow and the display changes to:

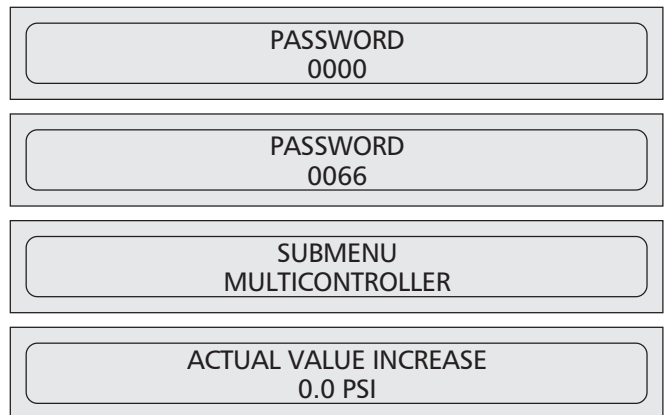

Generally a slight pressure drop is allowed on the first pump before the next is started. This allows for brief system fluctuations without pump cycling. Once the next pump starts, however, you will want the system to resume its normal set pressure.

# Programming

- 6) To do this, enter the amount of pressure drop you will allow before the next pump starts. Diagram 9 shows the pressure drop and increase.
- 7) To increase the pressure even more to compensate for system loss at higher flows, enter the total of the system drop allowed before next pump starts and the increased pressure desired.

For example, if the pressure drop allowed is 5 psi before the next pump starts, and the increased pressure needed to compensate for system losses is 3 psi, you would enter 5 + 3, or 8 psi to compensate for both system pressure drop and compensation requirements.

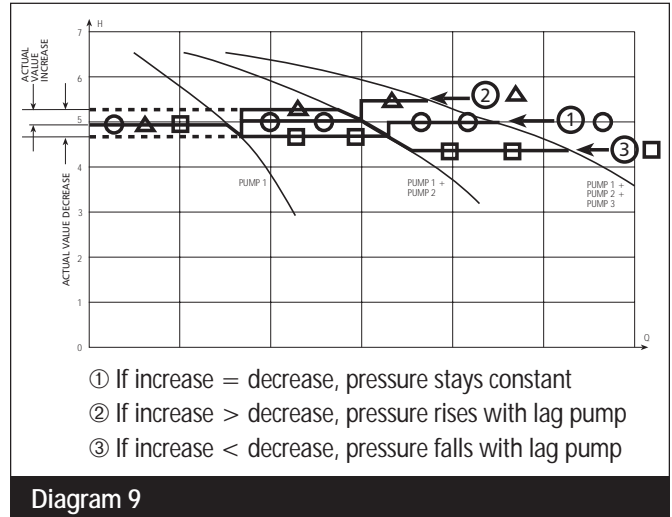

Diagram 9

## Note

This value is cumulative. An extra 3 psi will be added to the total system pressure with each additional pump which turns on. For example, if the initial system pressure was 50 psi, pump two would create 53 psi, pump three would create 56 psi, and pump four would create 59 psi system pressure.

## Instructions

- 8) Enter the required value by pressing the  $\uparrow$  arrow.
- 9) Press the  $\rightarrow$  arrow and the display will read:
- 10) Press the  $\uparrow$  arrow to enter the % drop before the next pump starts. Use this value for each pump in the Aquavar Model 56 Controller system.
- 11) Press the  $\rightarrow$  arrow to enter sequence control and then press  $\uparrow$ . This function tells the next pump when the preceding pump has reached its maximum speed.

**Notes:** In most North American applications, this would be set for 60 Hz. If you are using a 50 Hz system, reset the display for 50 Hz.

ACTUAL VALUE INCREASE 3.0 PSI
ACTUAL VALUE DECREASE 0.0 PSI
ACTUAL VALUE DECREASE 2.0 PSI
ENABLE SEQUENCE CONTROL 0 Hz
ENABLE SEQUENCE CONTROL 60 Hz

# Programming

12) Press the → arrow to display... then press the ↑ arrow to set the amount of time before the “lead” pump switches over to the next pump on the screen.

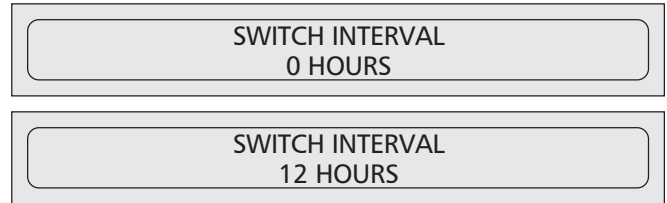

13) In this section you will give the pump an address number. Generally, the first pump programmed will be number 1, the second will be number 2, and so on. The purpose of this is to help the Aquavar Model 56 Controller sequence the start and stop activity of the pumps in the system including the selection of the lead and lag pumps (see Flowchart #5).

From the main menu press and hold the → for 3 seconds and you will reach the address detected screen.

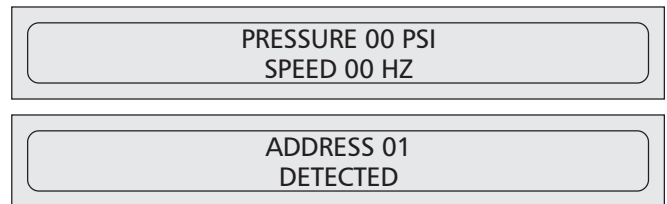

Press the ← arrow twice and you will reach the submenu address screen.

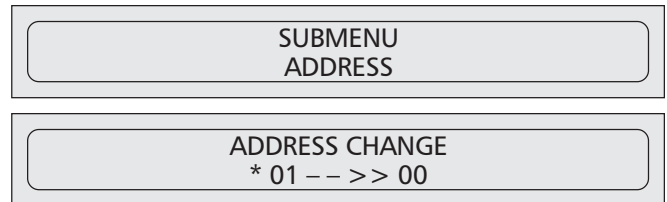

Press the ▼ arrow and the address change will appear.

00 - >>	00 01 - >> 00
01	01
02	02
03	03
04	04

Addresses from 01 to 04 and also 00 can be set in the parameter. To change the address it is not necessary to cut the interface connection to other AQUAVAR Model 56 Controllers.

On the left side is the address of the “LEAD” AQUAVAR Model 56 Controller. On the right side you can select the address of the AQUAVAR Model 56 Controller by pressing the ↑ or ↓ arrows.

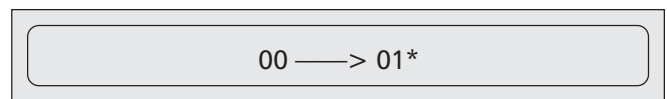

To change between the left and right side, press → or ←.

To leave the submenu press the → arrow for 3 seconds.

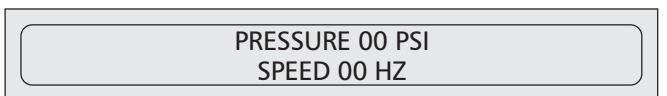

## VI. Slave Pump Operation (Flowchart #6)

- 1) From the **Parameter** screen on the main menu press the **↓** arrow and the display changes to:
- 2) Press the **↑** arrow until you reach the number 0066.
- 3) Press the **→** repeatedly until you reach:
- 4) Press the **↓** arrow and you will reach:
- 5) Press the **→** and you will see:
  - This is the frequency the slave pump will turn on and run at maximum speed. Adjust with **↑** and **↓** until you reach the desired setting. Generally this is at 60 Hz.
- 6) Press the **→** arrow until you reach:
  - This is the frequency the slave pump will turn off. Adjust with **↑** and **↓** until you reach the desired setting. Generally this is at 40 Hz.

PASSWORD  
0000

PASSWORD  
0066

SUBMENU  
RELAY

RELAY  
CONFIGURATION

SLAVE ON  
LIMIT

SLAVE OFF  
LIMIT

# Programming

## Multiple Pump – Constant Pressure (Flowchart #4)

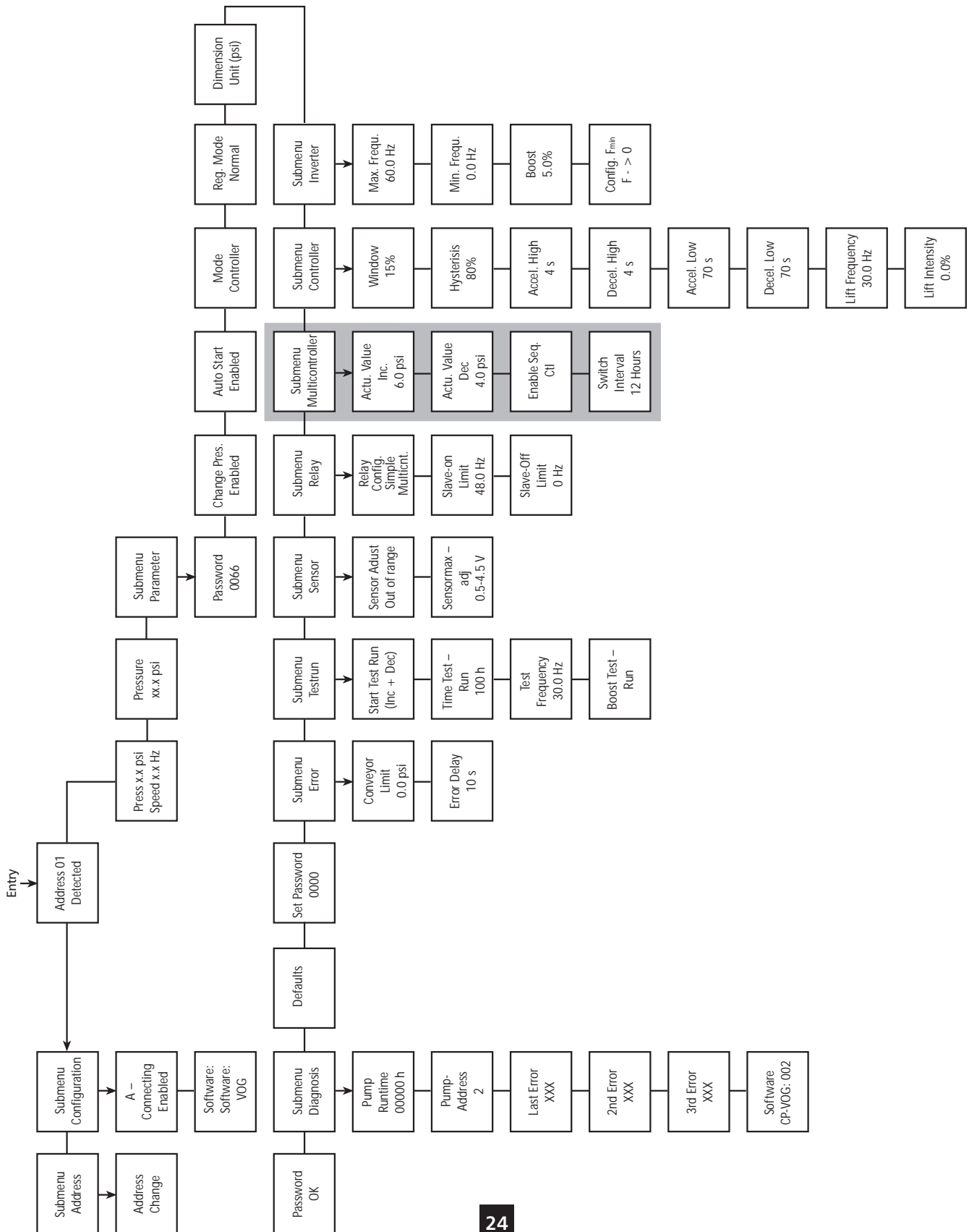

## Address Change (Flowchart #5)

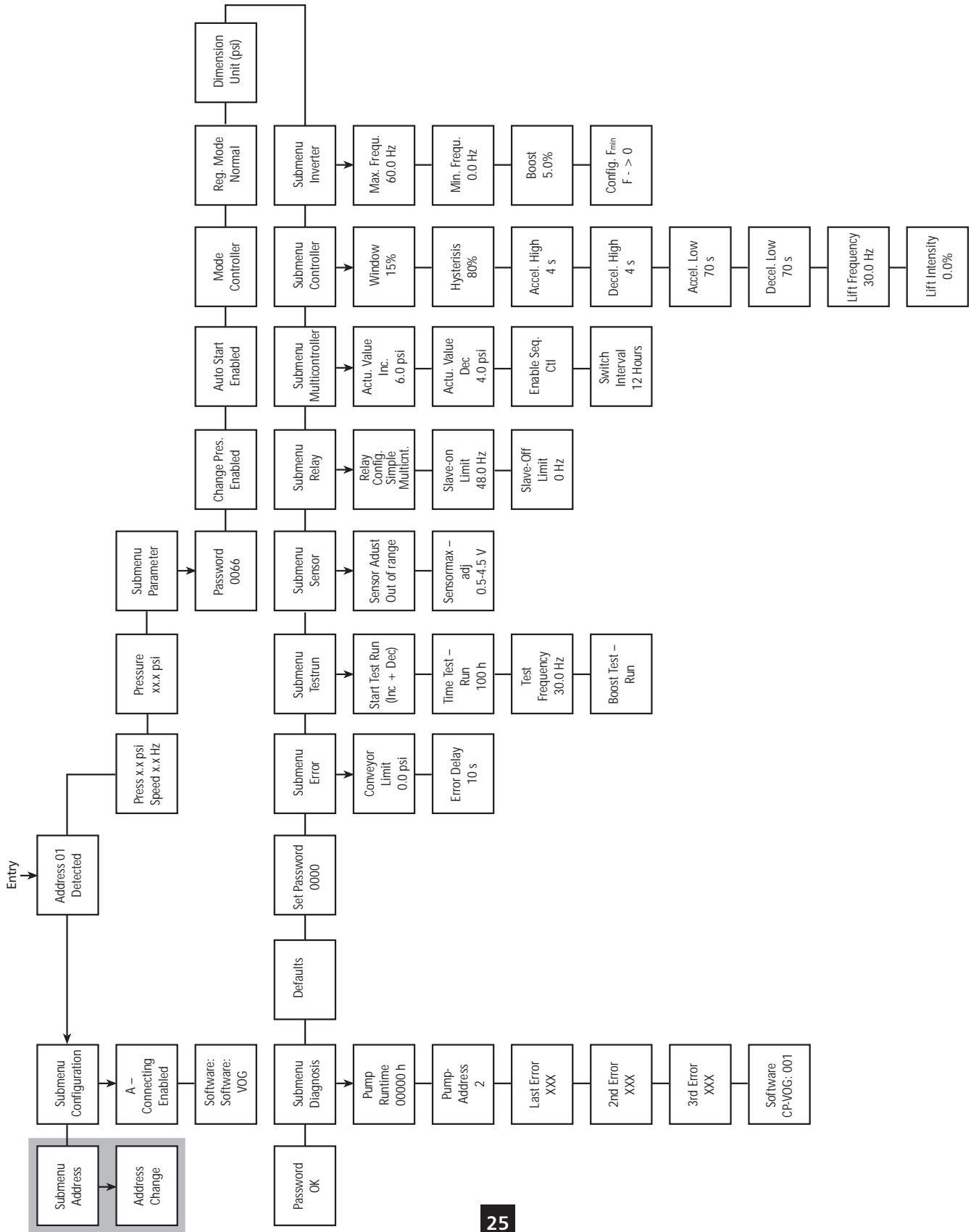

## Slave Pump (Flowchart #6)

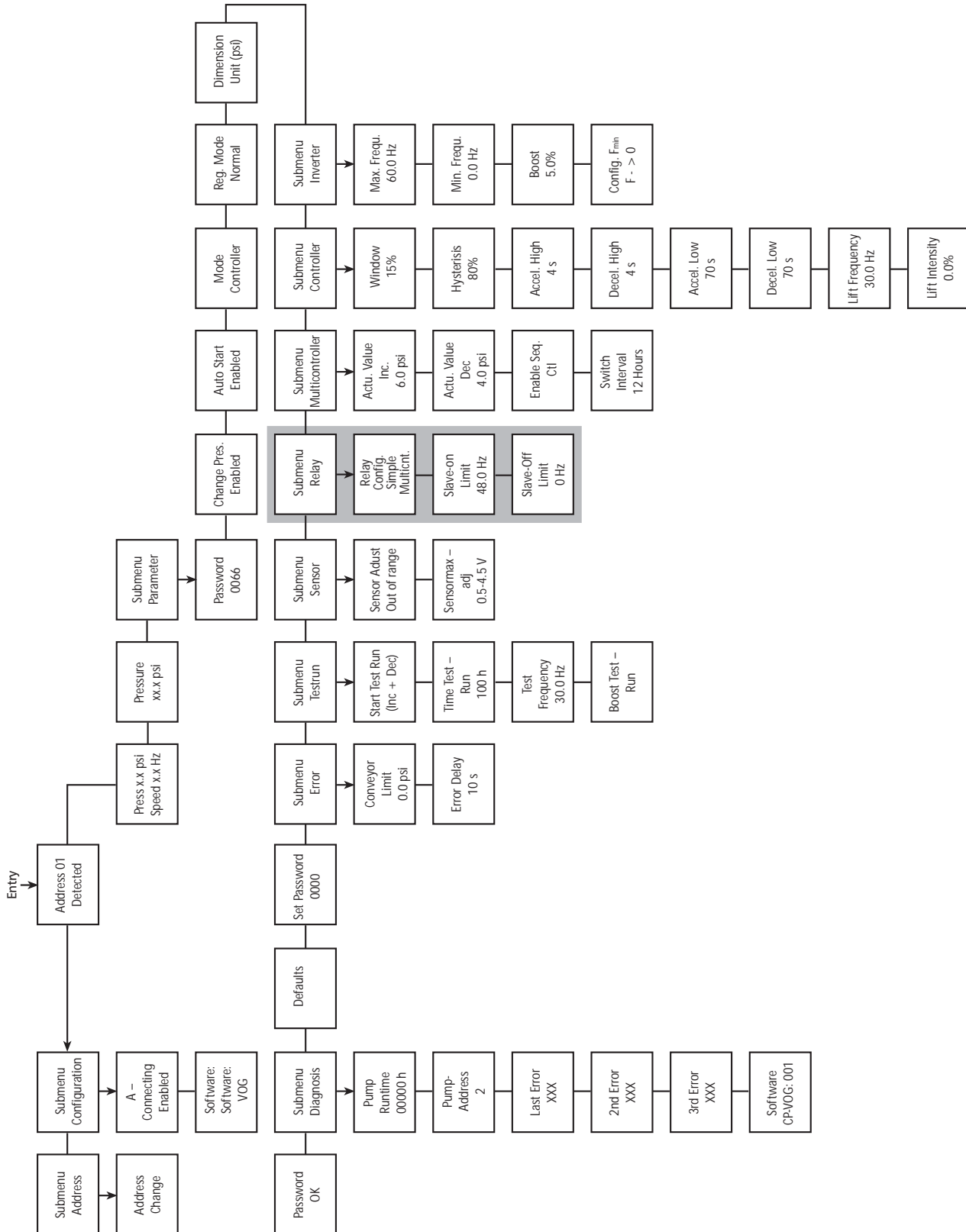

# Operator Custom Features and Displays

## Settings at the Inverter Menu

This message is shown during the connecting, when autoconnecting is enabled.

The actual input value (%) and the actual output frequency (Hz) are displayed.

Set required pressure with the buttons  $\uparrow$  and  $\downarrow$ .

To enter the submenu "Parameter", press  $\downarrow$  button.

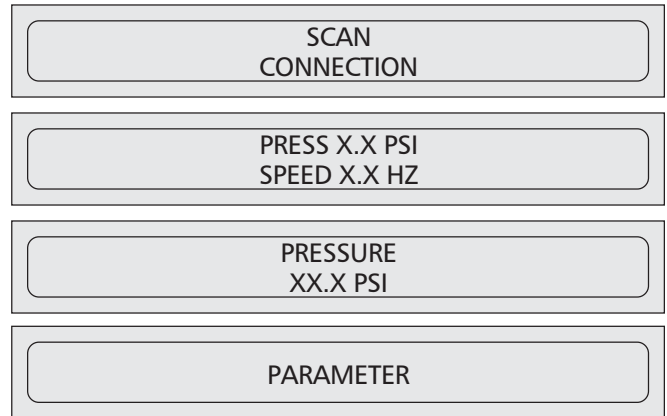

## Settings at the Submenu-Parameter



### IMPORTANT

Before entering the secondary menu these instructions must be read carefully to prevent incorrect settings which will cause malfunction.

After entering the "Submenu-Parameter" the display will change to:

Set 'Password 0066' by pressing  $\uparrow$  and  $\downarrow$

Confirm by resetting  $\rightarrow$  and the first window of the submenu is shown

**Pressure Change** You can decide between  $\uparrow$  and  $\downarrow$  (**Enabled or Disabled**). If the pressure setting is enabled, you can change the pressure on the AQUAVAR Model 56 Controller head with decrease and increase.

**Auto Start** You can select between  $\downarrow$  **Disabled** and  $\uparrow$  **Enabled**. Auto start Enabled means that the pump starts again automatically after an interruption of the power supply (power failure). If Auto start Disabled is set, the pump has to be restarted manually after a power failure, by pressing  $\downarrow$  and  $\uparrow$ .

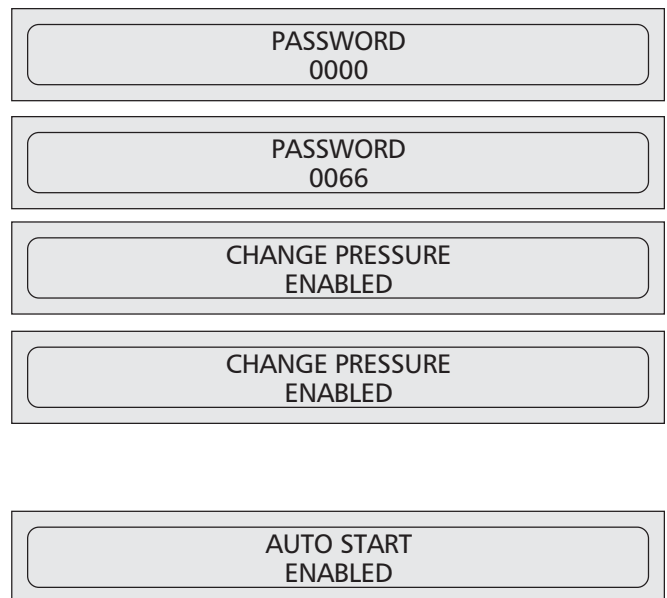

# Operator Custom Features and Displays

**Mode** Select with buttons  $\downarrow$  and  $\uparrow$  between:  
**Multicontroller**  $\rightarrow$  sequence control for max. 4 pumps.  
**Controller**  $\rightarrow$  pressure control for a single pump.  
**Actuator**  $\rightarrow$  external frequency setting. If only one AQUAVAR Model 56 Controller pump is in operation, set **Controller**.

If more than one AQUAVAR Model 56 Controller pumps are working together via the RS485-interface, the **Multi-controller** must be selected.

The application **Actuator** is only used if you have an external controller and the AQUAVAR Model 56 Controller works like a standard frequency converter (external frequency signal 0,5-4,5 VDC to the terminals X2/1 and 2).

**Control Response Normal** Speed is increased with falling actual value signals (e.g.: Control at constant output pressure). **Inverse** Speed is reduced with falling actual value signal, (e.g.: Control from falling suction pressure or at constant level).

**Dimension Unit** Here you could choose your favorite dimension ( $\downarrow$  or  $\uparrow$ ). psi, Bar, or %.

**Submenu Inverter** To enter this menu you have to press the  $\downarrow$  key, to leave the menu, press the  $\rightarrow$  key longer than 3 sec.

**Maximum Frequency** Possible setting between min. 40 and max. 60 Hz. Settings of 10% above nominal frequency cause 33% more power consumption!

**Minimum Frequency** Here you can set the minimum frequency. **ATTENTION:** If  $f_{\min} > 0$  is set, the pump will not stop in the normal mode. It will keep running with the set minimum frequency!! Possibility of **overheating** of the Pump!!!

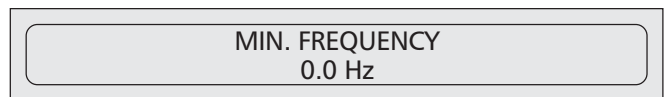
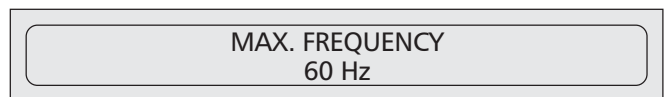
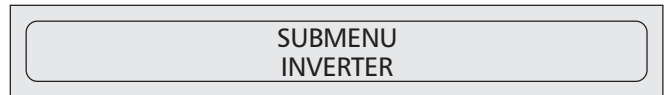
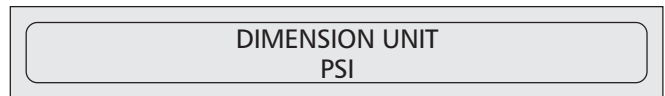
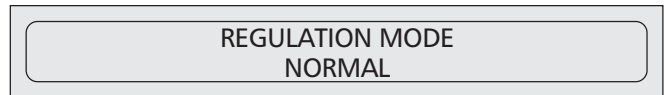
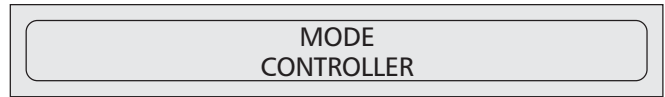

# Operator Custom Features and Displays

**Boost** The stated value determines the course of the V/f-curve. Setting of the motor starting voltage in % of rated voltage. Settings of 0 – 25% of maximum output voltage are possible. However, care should be taken that settings are kept as low as possible so that the motor does not become thermally overloaded.



**Operation of the minimum frequency**  
If you have selected  $F \rightarrow 0$  the frequency will go down to the selected minimum frequency. Then the inverter will run for the selected time, after this time the AQUAVAR Model 56 Controller will automatically stop.



With the selection  $F \rightarrow F_{min}$  you can not run the pump below the set minimum frequency. In the controller actuator and multicontroller mode the pump will never run below the set minimum frequency (the pump will only stop with the external on/off terminals or in case of a failure).

**F<sub>min</sub> Time** After running the pump for this selected time, the pump will stop, if parameter 12.6.5 is set on  $F \rightarrow 0$ .

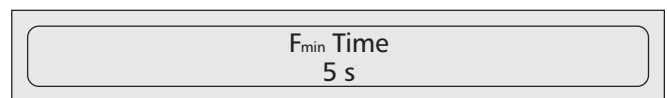

To enter or leave the submenu press the  $\rightarrow$  key longer than 3 seconds.

**Submenu Controller** To enter this menu you have to press the  $\downarrow$  key, to leave the menu, press and hold the  $\rightarrow$  key longer than three sec.

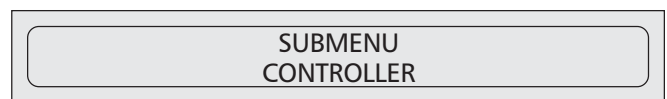

**Window – %** This value indicates the max. variation of the outgoing pressure (ref. Ramp window). Possible setting: between 0% – 100% of required pressure.

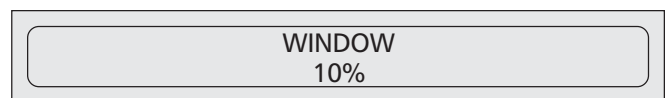

# Operator Custom Features and Displays

**Ramp Hysteresis Level** Where the fast ramp changes to the slow ramp. Possible setting: between 0% – 100% of the window.

HYSTERISIS  
80%

**Fast Acceleration Time** Time setting at Ramp 1, 2, 3, or 4 will influence the control of the pump and **MUST NOT BE CHANGED** for normal operation. Possible setting for each ramp 0,05 – 1000 sec. Excessively fast running time may overload the inverter. Excessively slow running up time may cause a break down of the outgoing pressure.

ACCEL. HIGH  
4 SEC.

**Fast Deceleration Time** Excessively fast running down time tends to cause oscillation or hunting or can cause an error (OVERVOLTAGE) during slow down of the pump. Excessively slow running down time tends to generate over pressure.

DECEL. HIGH  
4 SEC.

**Slow Acceleration Time** Too slow of a running up time during variation of demand can cause the outgoing pressure to break. Too fast of a running up time may lead to over oscillation and/or overload of the inverter.

ACCEL. LOW  
70 SEC.

**Slow Deceleration Time** Too fast a setting leads to oscillation. Too slow a setting delays switching off too much.

DECEL. LOW  
70 SEC.

## Ramp Window

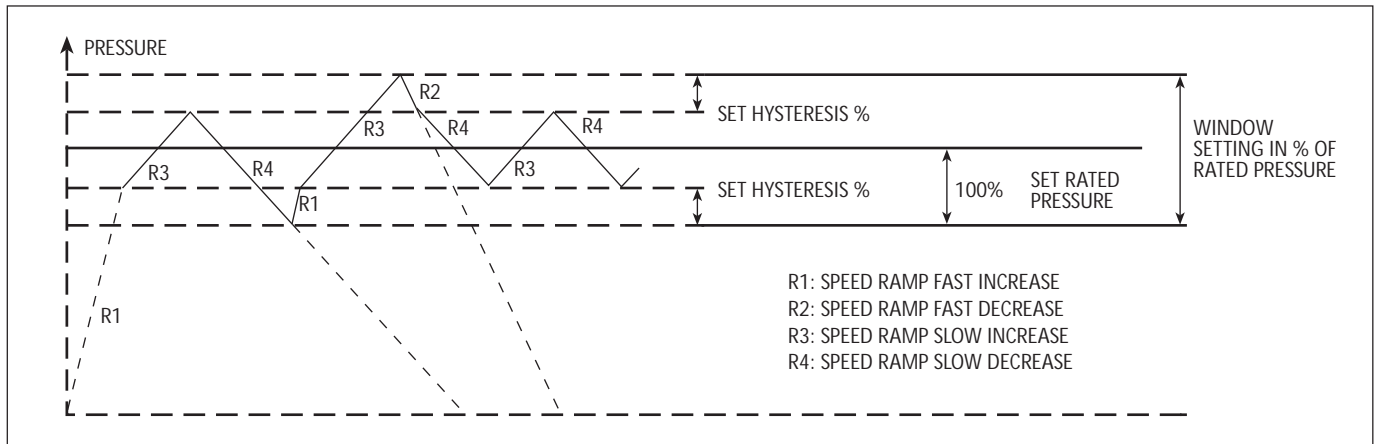

Diagram 10

# Operator Custom Features and Displays

**Compensation Frequency Control** according to a unit curve (increase of the set pressure dependent upon the delivery rate or speed). Adjustable between 6 Hz and the set MAXIMUM FREQUENCY, this setting states at which frequency the set pressure should be increased. That is the speed at which the pump works at the set pressure and at a flow rate of 0.

**Lift-Intensity** Adjustable from 0% to 100%. This value states how much the set value should be continually increased, till the maximum speed (maximum volume) is reached.

Figure: Lift-Intensity

LIFT FREQUENCY  
30.0 Hz

LIFT - INTENS.  
0.0%

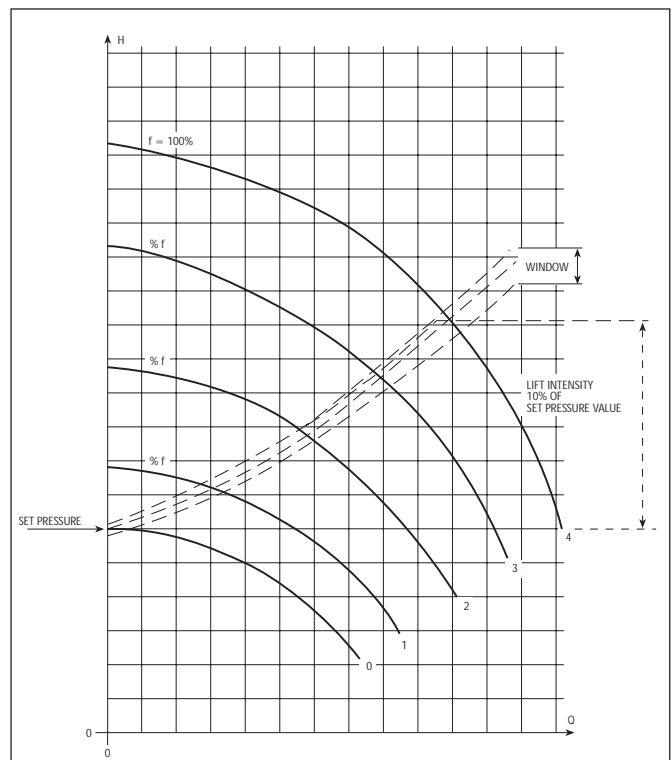

Diagram 11

To leave the submenu press the ← key longer than 3 seconds.

**Submenu Multicontroller** To enter this menu you have to press the ↓ key. To leave the menu, press the → key longer than 3 seconds.

SUBMENU  
CONTROLLER

# Operator Custom Features and Displays

**Lift Value** Adjustable between 0 to the pre-selected NORMALIZE. Application Example: 1) Pump 1 reaches  $f_{max}$  (maximum speed, 2) Pressure falls and reaches the start-value of the 2nd pump (= REQUIRED VALUE - ACTU. VALUE DEC.), 3) Pump 2 is switched on automatically, 4) The required value is calculated after the start of the 2nd pump in the following way.  
 New required value = REQUIRED VALUE – ACTU. VALUE DEC. + ACU. VALUE INC.

ACTU. VALUE INC.  
5 PSI

## GENERAL

- 1) If Actual Value Increase equals Actual Value Decrease the pressure stays constant throughout flow range.
- 2) If Actual Value Increase is greater than Actual Value Decrease, the pressure rises as the lag pumps turn on and the flow increases.
- 3) If Actual Value Increase is less than the Actual Value Decrease, the pressure drops as the lag pumps turn on and the flow increases.

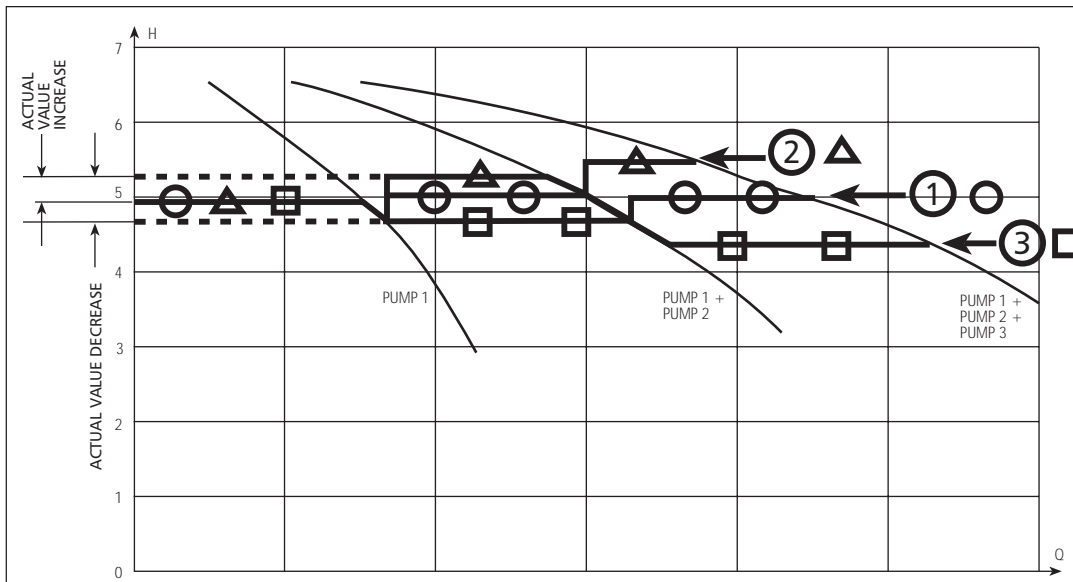

Diagram 12

**Fall Value** For scaling the set pressure of pumps 1 to 4. Adjustable from 0.0 to 100% determines the start-value of the 2<sup>nd</sup> pump and the other following pumps. (start value = REQUIRED VALUE - ACT. VALUE DEC.)

ACTU. VALUE DEC.  
4 PSI

# Operator Custom Features and Displays

**Release – Follower Control** Enabling of the lag pump only when required (the fall-value is reached) and if the lead pump has reached the programmed frequency. (Adjustable from 0.0 Hz to 120 Hz). If you don't want to start a lag pump this value has to be set higher than the MAX. FREQUENCY.

ENABLE SEQ. CTL.  
45.0 Hz

**Switch Interval** For changing the lead pump and lag pump in order to achieve even operating hours. Adjustable between 0 and 250 hours.

SWITCH INTERVAL  
12 HOURS

To leave the submenu press the → key longer than 3 seconds.

**Submenu Relay** To enter this menu you have to press the ↓ key, to leave the menu, press the → key longer than 3 seconds.

SUBMENU  
RELAY

**Relay Configuration** Possible selections with buttons ↓ and ↑: Simple Multicnt. → Starts a following pump (slave pump) with constant speed.

RELAY CONFIG.  
SIMPLE MULTICNT.

Run Signaling → Run indication over the relay  
Error Signaling → Fault indication over the relay

**Start Frequency of the Slave Pump** Here you can set the frequency of the speed controlled AQUAVAR Model 56 Controller pump, where the full speed slave pump starts, if "simple multi-controller" is set in the parameter relay configuration. In this case, the slave pump runs with full speed and the AQUAVAR Model 56 Controller pump controls the additional demand. Typically set at 60 Hz.

SLAVE-ON LIMIT  
48,0 Hz

**Stop Frequency of the Slave Pump** Here you can set the frequency of the speed controlled AQUAVAR Model 56 Controller pump, where the full speed slave pump stops, if "simple multi-controller" is set in the parameter relay configuration. Typically set at 40 Hz.

SLAVE-OFF LIMIT  
0.0 Hz

To leave the submenu press the → key longer than 3 seconds.

# Operator Custom Features and Displays

**Submenu Sensor** To enter this menu you have to press the **↓** key, to leave the menu, press the **→** key longer than 3 seconds.

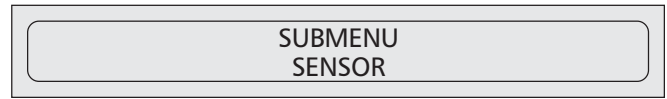

**Sensor – Adjust** (Zero adjustment of the transmitter) Depressurize the system and press keys **↓ + ↑** simultaneously. After adjustment “adjusted” appears on the display. If “out of range” is shown on the display, no adjustment is possible.

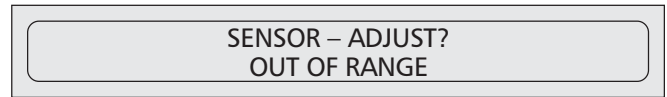

**Sensor Max-Adjust** The analogue input (terminal X2/2) is prepared for a transmitter signal of 0,5 - 4,5VDC (= 100%). When there is a transmitter with another signal range used, you have to adjust this other voltage range in this parameter.

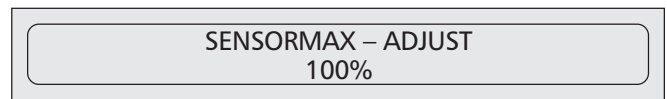

To leave the submenu press the **→** key longer than 3 seconds.

**Submenu Test-Run** To enter this menu you have to press the **↓** key, to leave the menu, press the **→** key longer than 3 seconds.

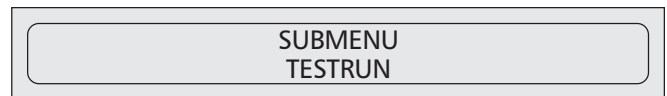

**Start Test Run** By simultaneously pressing **↑ + ↓** a test run will be released even if the test cycle is not set.

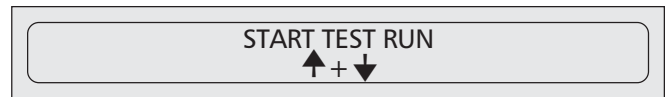

## Sequence for Automatic Test Run

Adjustable between 10 – 100 hours. The test run starts the pump for 20 seconds at 30 Hz at the set time after the last stop. Deactivating test run: Set 0 hours, by using **↑** and **↓**. Repeating the test run: Select test run and set the desired hours using the key **↑**.



**Test Run: Frequency** Frequency for manual test run can be set from 0 Hz to 60 Hz.

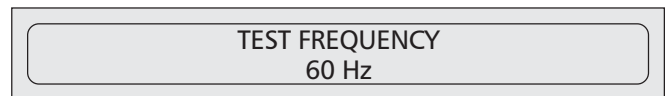

**Test Run: Boost** Start voltage in % of rated voltage in order to ensure that the motor starts safely. Adjustable between 0% and 25%.

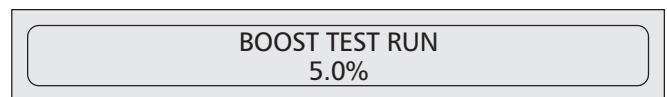

To leave the submenu press the **→** key longer than 3 seconds.

# Operator Custom Features and Displays

**Submenu Error** The inverter tries to reach a defined pressure limit in a defined time. If this is not possible the inverter stops. To enter this menu you have to press the ↓ key, to leave the menu, press the → key longer than 3 seconds.

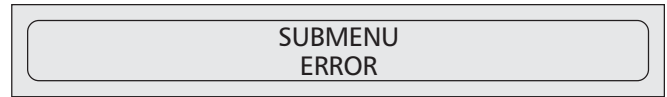

**Conveyor Limit** Disabled or adjustable between 0.00 and 100%. To disable the conveyor limit, press ↓ till "0.0%" is shown on the display. To set a % pressure the ↓ or ↑.

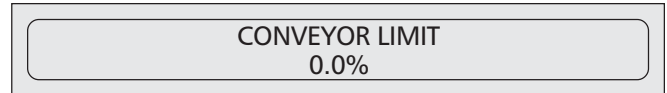

**Error Delay** Adjustable between 0 and 100 sec. Delayed switch-off in the event of low water, (suction side switch connected to terminal X2/6-X2/7) and also for the conveyor limit. Time Setting.



To leave the submenu press the → key for longer than 3 seconds.

**Set Password** The pre-set password can be changed if necessary with the ↑ and ↓ keys.

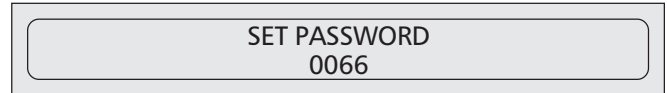

**Default Settings** To load DEFAULT – PARAMETER, press buttons ↑ + ↓ together, until the timer is run down.

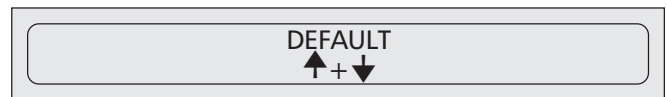

**Submenu Diagnosis** To enter this menu you have to press the ↓key, to leave the menu, press the → key longer than 3 seconds.

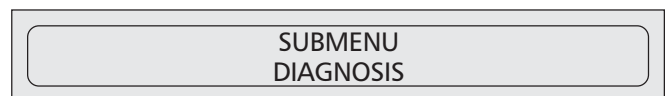

**Pump Runtime** Shows the run time of the pump.

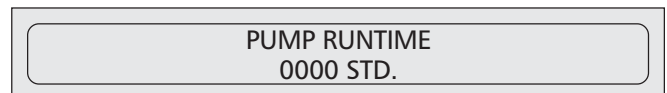

**Pump Address** This window shows the adjustment of the pump address, Read Only.

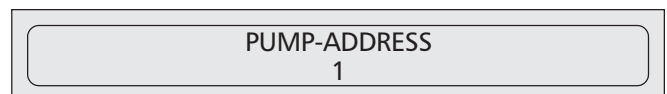

- \* The last three error signals are always stored with Signal Error 1 to 3.
- \* The error signals can not be deleted.
- \* The signal ERROR 1 shows the last error to have occurred.

# Operator Custom Features and Displays

LAST ERROR:

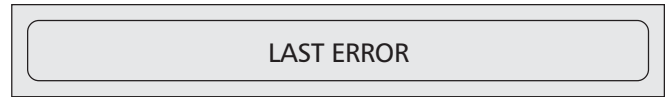

Error before the last error:

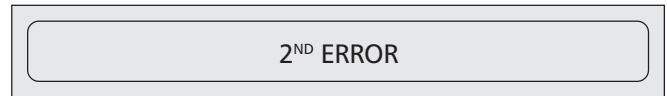

Error before error 2:

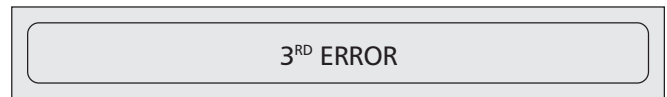

**Software Version** This parameter shows the software version of the AQUAVAR Model 56 Controller.



To leave the submenu press the ← key for 3 seconds.

**Set Password** Here the set or changed password is confirmed.



## Controller Menu

**Controller menu Configuration** To enter this menu you have to press the ↑ key, to leave the menu, press the → key longer than 3 seconds.

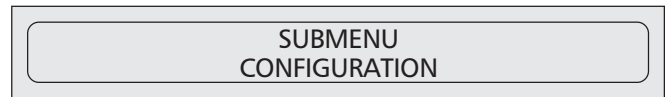

**Automatic connection to the programming device** Only valid for programming device! Autoconnecting enabled means that after plug in of the programming device, it changes automatically to the converter menu. During this auto connection "SCAN CONNECTION" is shown on the display.

**ATTENTION!** Autoconnecting will be stored after leaving the submenu Configuration. If autoconnection is enabled, do not plug the programming device into an AQUAVAR Model 56 Controller which runs in the multi-controller mode together with other AQUAVAR Model 56 Controller pumps via the RS485-interface.

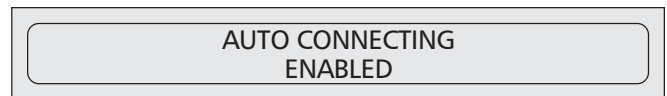

**Software Version** In the second line of the display, the version of the software for the programming Device is shown and also the software date.

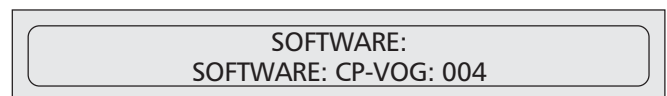

To leave the submenu press the → key for longer than 3 seconds.

# Operator Custom Features and Displays

**Controller Menu Address** To enter this menu you have to press the ↓ key, to leave the menu, press the → key longer than 3 seconds.

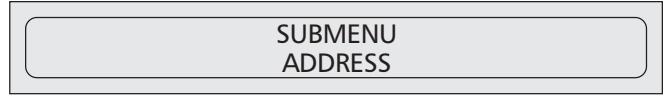

**Change of Pump Address** Addresses from 01 to 04 and also 00 can be set in this parameter. To change the address it is necessary to cut the interface connection to other AQUAVAR Model 56 Controllers. The address of the AQUAVAR Model 56 Controller is shown on the left side. On the right side, you can give the AQUAVAR Model 56 Controller a new address with the buttons ↑ and ↓. You only can give an address, which is not used in the pump group. To change between left and right side, press button → or ←. The star shows the actual side used. If you select address 00, this setting will be accepted after release of the button.



To leave the submenu press the → key for 3 seconds.

## Error Signals

**Low Water Remedy:** Check suction pressure. If suction pressure is normal the unit restarts itself. If there is no suction pressure switch (e.g. circulating systems), bridge terminals X2/6 and X2/7. (Jumper wire if not used.)

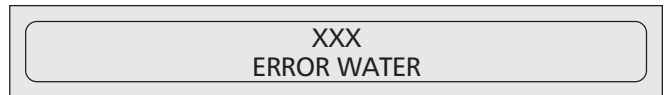

**Overheating – Motor** Possible causes: Insufficient cooling ambient temperature is too high, motor overloaded. After the cause has been remedied, the malfunction has to be reset by cutting off the power supply for > 30 seconds.

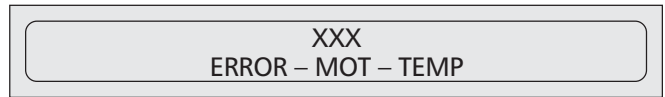

**Overvoltage** Possible cause: Check main supply, supply voltage too high, peak voltage due to switching heavy loads on the network, or RAMP 2 is too fast. Find the cause and take countermeasures (e.g. line filter, RC-elements). Disconnect the power supply for > 30 seconds.



# Operator Custom Features and Displays

**Undervoltage** Possible cause: Check main supply, faulty fuse or out of phase.

XXX  
ERROR – UNDERVOLT

**Overload** Possible causes: false data settings or the pump is working at a capacity, excessive amp draw significantly in excess of its performance data.

XXX  
ERROR OVERLOAD

Ramp 1 too fast. Check motor for proper rotation or rubbing.

Max. frequency exceeded

Boost too low

Disconnect the power supply for > 30 seconds

**Overtemp. Heat Sink** The thermal sensor on the heat sink indicator over temperature.

XXX  
ERROR KK – TEMP

Possible causes: insufficient cooling, ambient temperature too high or motor overload. After remedy, cut off power for > 30 seconds to reset.

**Sensor Fault** A sensor signal of below .5 VDC was received due to bad sensor, broken cable or bad connection. After remedy cut off power for > 30 seconds to reset.

XXX  
SENSOR FAULT

**Conveyor Limit Fault** The minimum set point value is not reached within the delay time.

XXX  
ERROR WATER

Possible causes are pipe breakage, a closed suction valve or air in the pump. After remedy cut off power for > 30 seconds to reset.

## Additional Error Signals:

ERROR 1: EEPROM–ERROR

(corresponding data block malfunction)

ERROR 2: Not used

ERROR 3: Processor RAM error

ERROR 4: Not used

ERROR 5: Processor ROM error

ERROR 6: Watchdog error

ERROR 7: Clock error (quartz)

ERROR 8: Program error

These ERROR signals are acknowledged by disconnecting the power supply for > 30 seconds. If the error signal should appear again, contact customer service and provide a detailed description of the error.

# Appendix A

## Pressure Transducer

The sensor of this transducer is a piezoresistive silicon pressure sensor, mounted on a tape (TAP) floating freely in an oil chamber. The pressure is transferred to the sensor by a separating nickel diaphragm in the oil chamber.

### Specifications

Range (FS): 150 psi (other range upon request)  
Over-pressure-Pmax: 300 psi  
Class of protection: IP 67

### Type

Signal Over Range: 0,5 - 4,5 V DC (ratiometric)  
Supply: 5 VDC +/- 025 VDC

### Sealed gauge:

### Supply:

+ VCC => red = supply voltage  
+ Out => white analogue output signal  
GND => black ground

Operating Temperature: -20 - +80°C  
Storage Temperature: -40 - +100°C

Material: Body Steel and Brass  
Diaphragm: Nickel

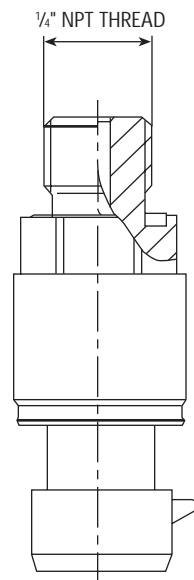

Pressure Transducer

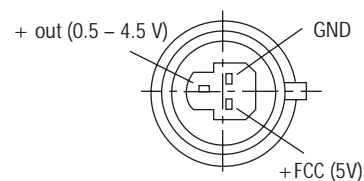

Plug

# Appendix A (continued)

## Differential Pressure Transducer

The sensors of this differential pressure transducer are two piezoresistive silicon pressure sensors, mounted on a tape (TAP) freely floating in an oil chamber. The pressure is transferred to the sensor by a separate steel diaphragm in the oil chamber.

### Specifications

Range (FS): 4 bar (differential)  
Over-pressure-Pmax: 16 bar (single-sided)  
Class of protection: IP 65

### Type

Signal Output: 0,5 - 4,5 V DC (ratiometric)  
Supply: 5 VDC +/- 10%  
Load Resistance:  $\geq 5 \text{ k}\Omega$   
Linearity:  $\pm 0.20 \%$  FS; max.  $\pm 0.5\%$  FS  
Stability:  $\pm 0.1 \%$  FS; max.  $\pm 0.2\%$  FS

Operating Temperature: -10 - +80°C  
Storage Temperature: -40 - +100°C

Material: Body and diaphragm: 1.4435 Stainless Steel  
Screw Joint and Cover:

### Sealed gauge:

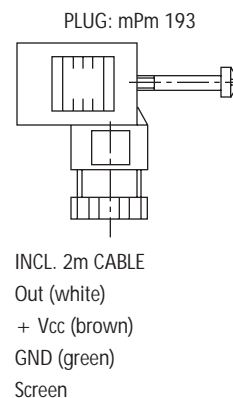
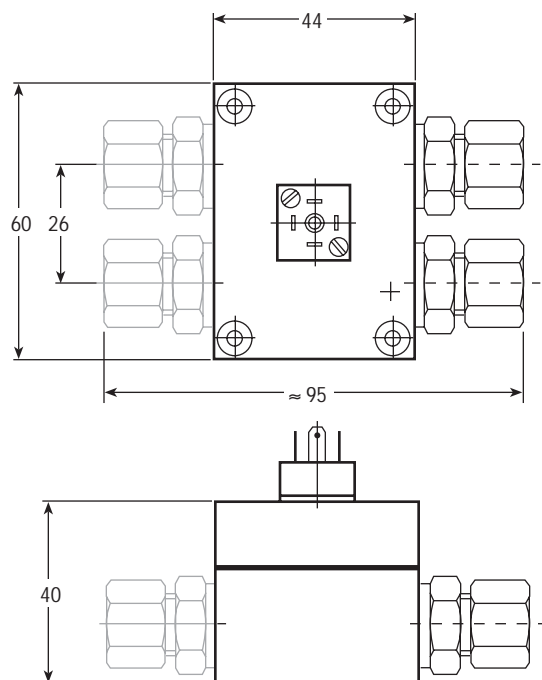

## AQUAVAR Model 56 Controller Drive Head Technical Data

AQUAVAR Model 56 Controller		Supply	Motor		Voltage Protection
Type	Rated output	Voltage			
AV 1.1	1 HP	1 x 230 V / 40-60 Hz	3 x 230 V	4,8 A	10 Ampere
AV 1.15	2 HP	1 x 230 V / 40-60 Hz	3 x 230 V	7,0 A	10 Ampere
AV 1.2	3 HP	1 x 230 V / 40-60 Hz	3 x 230 V	10,0 A	16 Ampere

Input Voltage: 1 x 230 VAC  $\pm$  10% (An input line reactor is highly recommended for areas which experience voltage fluctuation.)

Output Voltage: 3 x 230 Volt AC

Max. Frequency: 40 – 60 Hz – selectable

Min. Frequency: 0 - f-max

Electrical Efficiency: > 95%

Protection against: Short circuit, under-voltage, overheating of the electronics (overload) and additional protective functions via external switch (motor temperature, low water).

A power supply filter is included to ensure interference immunity.

The AV Series frequency converter complies with the general EMV provisions and has been tested according to the following standards:

- Radio Interference Suppression EN 50081 Part 2 and EN 50082 Part 2
- High Frequency Field Interference ENV 50140 and ENV 50141
- Static Electricity Discharge EN 61000-4
- Disturbance Voltage EN55011

Ambient Temperature: 5° C – 40° C

Storage Temperature: -25° C – +55° C  
(+ 70° C during max. 24 hours)

Humidity: rH max. 50% at 40° C, unlimited  
RH max. 90% at 20° C, max. 30 days per year  
Condensation not permitted!

Air Pollution: The air may contain dry dust as found in workshops where there is no excessive quantity of dust due to machines. Excessive amounts of dust, acids, corrosive gases, salts, etc. are not permitted.

Class of Protection: UL, CUL, NEMA 4, IP 55

Altitude: Maximum 3000 feet above sea level. Consult factory for higher altitudes.

### Drive Head Technical Data (continued)

- X2**
- 1 - Ground Connection
  - 2 - Actual value input 0.5 - 4.5 VDC, 50 ohm load resistance
  - 3 - Power source for external control, 5 VDC
  - 4 - Ground connection for external on/off
  - 5 - External on/off connection, 10K ohm, 5 VDC gold plated contact.  
If no external control is used, a jumper wire is installed on contacts 4 and 5.
  - 6 - Ground connection for low water switch
  - 7 - Low water switch connection. If no switch is used a jumper wire is installed on contacts 6 and 7.
  - 8 - Connection for thermistor
  - 9 - Connection for thermistor
  - 10 - Normally closed contact for slave pump
  - 11 - Common contact for slave pump
  - 12 - Normally open contact for slave pump
- X3**
- 1 - RS 485 connection. S10 - (low) for connection of AQUAVAR Model 56 Controller to other AQUAVAR Model 56 Controller units in a set.
  - 2 - RS485 interface connection. S10 + (high) for connection of the AQUAVAR Model 56 Controllers to other AQUAVAR Model 56 Controller units.
  - 3 - RS485 interface connection. Common ground.
  - 4 - RS485 interface connection. +SVDC output signal. Maximum 20m Amp output.
- NOTE:** When connecting the variable speed pumps (max. 4 pumps) via the interface RS485, the terminals X3 #1, X3 #2, X3 #3 are to be connected in parallel by means of a shielded cable to every AQUAVAR Model 56 Controller drive head.

### GOULDS PUMPS LIMITED WARRANTY

This warranty applies to all water systems pumps manufactured by Goulds Pumps.

Any part or parts found to be defective within the warranty period shall be replaced at no charge to the dealer during the warranty period. The warranty period shall exist for a period of twelve (12) months from date of installation or eighteen (18) months from date of manufacture, whichever period is shorter.

A dealer who believes that a warranty claim exists must contact the authorized Goulds Pumps distributor from whom the pump was purchased and furnish complete details regarding the claim. The distributor is authorized to adjust any warranty claims utilizing the Goulds Pumps Customer Service Department.

**The warranty excludes:**

- (a) Labor, transportation and related costs incurred by the dealer;
- (b) Reinstallation costs of repaired equipment;
- (c) Reinstallation costs of replacement equipment;
- (d) Consequential damages of any kind; and,
- (e) Reimbursement for loss caused by interruption of service.

**For purposes of this warranty, the following terms have these definitions:**

- (1) "Distributor" means any individual, partnership, corporation, association, or other legal relationship that stands between Goulds Pumps and the dealer in purchases, consignments or contracts for sale of the subject pumps.
- (2) "Dealer" means any individual, partnership, corporation, association, or other legal relationship which engages in the business of selling or leasing pumps to customers.
- (3) "Customer" means any entity who buys or leases the subject pumps from a dealer. The "customer" may mean an individual, partnership, corporation, limited liability company, association or other legal entity which may engage in any type of business.

**THIS WARRANTY EXTENDS TO THE DEALER ONLY.**

Goulds Pumps and the ITT Engineered Blocks Symbol are registered trademarks and tradenames of ITT Industries.