

Fluid-o-Tech rotary vane pumps 4000 series



The 4000 series rotary vane pumps, available in 7 different displacements, are the latest edition of Rotoflow high technology volumetric pumps. The pump housing, the rotor and every metallic component are in AISI 303 stainless. AISI 316 is also available.

The pumping chamber and the vanes are in high impact carbon graphite. The self-lubricating property of polished stainless steel and carbon graphite makes this pump well suited for water and water based solutions.

Inlet/outlet ports are 1" NPT female threaded (1" GAS available upon request). All models are available with NBR or Viton seals.

Main applications

- Reverse osmosis systems
- Cooling systems
- Car wash

Max. size of solid particles: 20 μ

Max. motor speed: 1725 rpm

Max. temperature: 90°C (194 F)

Max. system pressure: 25 BAR (360 PSI)

(Safety valve recommended)

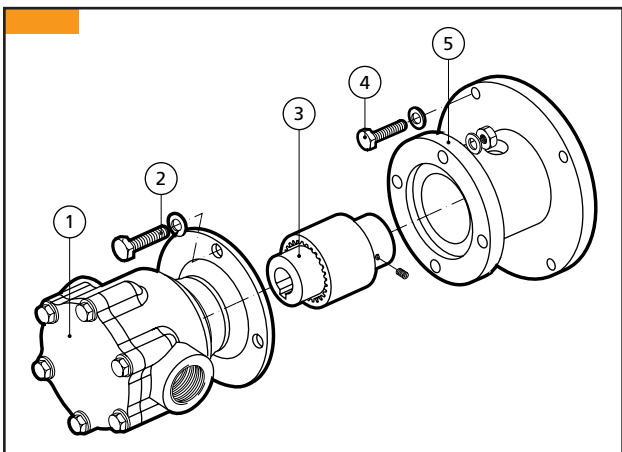
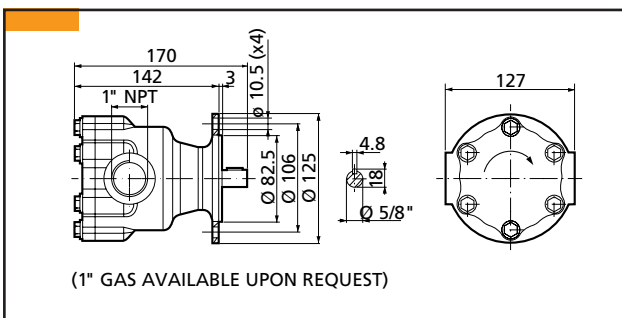

Pos.	Description	Material	Code
1	Pump	STAINLESS STEEL	-
2	Screw M10 x 35	STEEL	6300190
	Washer		6300230
	Nut M10		6300270
3	Coupling M90	CAST IRON	3300080
	Coupling Nema 56C		3300100
	Coupling Nema 143TC-145TC		3300090
4	Screw M8 x 25 for M90 B14	STEEL	6300160
	Washer for M90 B14		6300220
	Screw 3/8"x1" for Nema 56C-143TC-145TC		6300200
	Washer for Nema 56C-143TC-145TC		6300230
5	Adapter M90 B14	ALUMINIUM	6300180
	Adapter M90 B14 with screws		3300040
	Adapter Nema 56C-143TC-145TC		6300250
	Adapter Nema 56C-143TC-145TC with screws		3300060



Fluid-o-Tech
<http://www.fluidotech.it>

Via Morimondo, 23
 20143 Milano - Italy
 Tel. (39) 02 8917071
 Fax (39) 02 89170799

161 Atwater St.,
 Plantsville CT (USA) 06479
 Tel. (1) (860) 276-9270
 Fax (1) (860) 620-0193

AF204, 8-10-17, Fukasawa,
 Setagaya, Tokyo 158-0081 Japan
 Tel. (81) (0) 3-3705-5440
 Fax (81) (0) 3-5707-7414

Fluid-o-Tech rotary vane pumps 4000 series

	2 BAR	6 BAR	10 BAR	14 BAR	18 BAR	
MODEL	FLOW l/h	FLOW l/h	FLOW l/h	FLOW l/h	FLOW l/h	FIGURE
PO4010	1114	1095	1076	1057	1038	A-A'
PO4020	1320	1301	1282	1263	1244	B-B'
PO4040	1526	1507	1488	1469	1450	C-C'
PO4060	1732	1713	1694	1675	1656	D-D'
PO4080	1938	1919	1900	1881	1862	E-E'
PO4100	2144	2125	2106	2087	2068	F-F'
PO4120	2350	2331	2312	2293	2274	G-G'

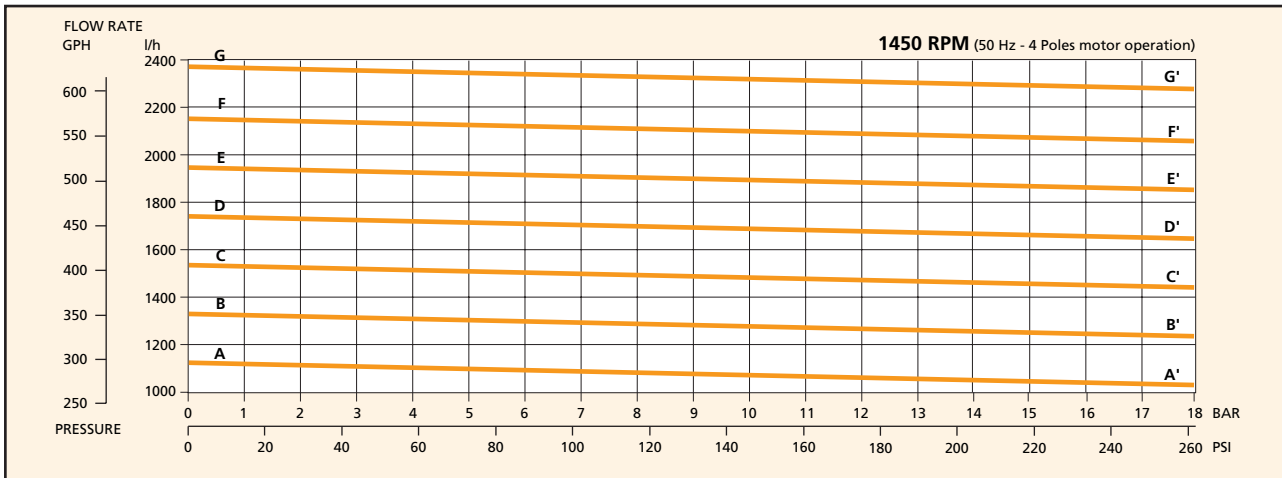

	20 PSI	80 PSI	140 PSI	200 PSI	260 PSI	
MODEL	FLOW GPH	FLOW GPH	FLOW GPH	FLOW GPH	FLOW GPH	FIGURE
PO4010	345	340	335	330	325	A-A'
PO4020	410	405	400	395	390	B-B'
PO4040	475	470	465	460	455	C-C'
PO4060	540	535	530	525	520	D-D'
PO4080	605	600	595	590	585	E-E'
PO4100	670	665	660	655	650	F-F'
PO4120	740	735	730	725	720	G-G'

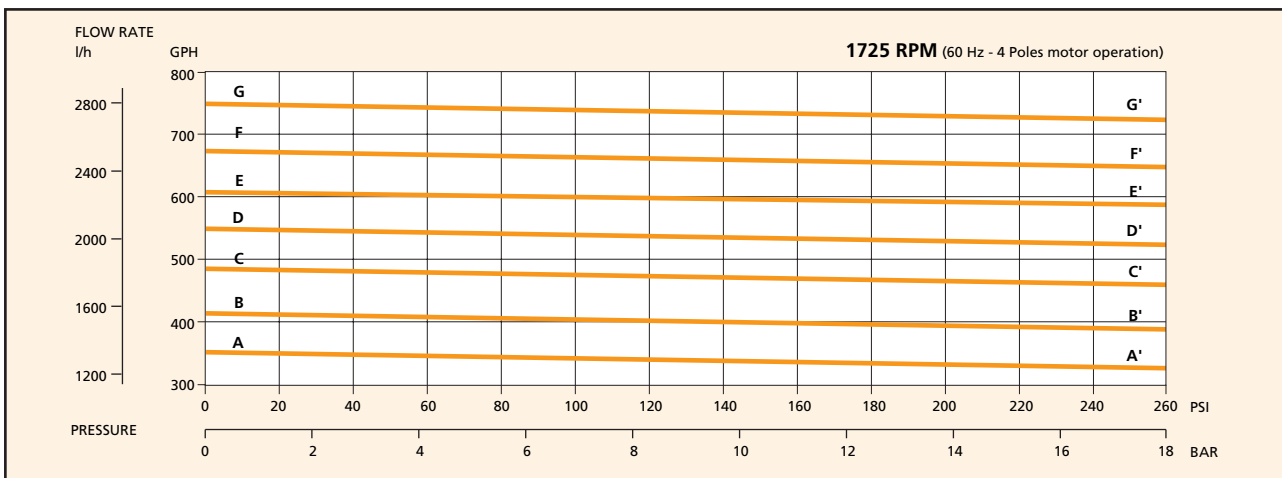

Note: Characteristics at constant motor speed with water at 20°C - Figures of flow are averages - Pump weight 5,3 kg

For applications involving other fluids, high temperatures or unusual processing conditions, please consult the factory or an authorized Fluid-o-Tech distributor

PO-4000 - 02/03 Ed.



Fluid-o-Tech
<http://www.fluidotech.it>

Via Morimondo, 23
 20143 Milano - Italy
 Tel. (39) (02) 8917071
 Fax (39) (02) 89170799

161 Atwater St.,
 Plantsville CT (USA) 06479
 Tel. (1) (860) 276-9270
 Fax (1) (860) 620-0193

AF204, 8-10-17, Fukasawa,
 Setagaya, Tokyo 158-0081 Japan
 Tel. (81) (0) 3-3705-5440
 Fax (81) (0) 3-5707-7414