



VKC 11 SERIES

Sealless, Non-Metallic Vertical Pumps

Installation and Maintenance Instructions

Pat. No. 5,708,313

ASSEMBLY

PUMPS WITH MOTORS

1. No assembly required. Simply unpack the pump and motor and examine for any signs of shipping damage. If damage is detected, save the packaging and notify the carrier immediately.
2. Ensure that lock rings are securely snapped in place and did not loosen during shipment.
3. Proceed to the "Installation" section of these instructions.

PUMPS WITHOUT MOTORS:

(56C/143-145TC FRAME)

1. Unpack the pump and any supplied accessories and examine for damage. If damage is detected, save the packaging and notify the carrier immediately.
2. Create a hole if required for discharge piping in the optional mounting plate (item 9) at desired location.
3. Prepare to install the motor on the pump. Carefully place the motor on the fan cover on a suitable, level work surface.
4. Install key into motor shaft key slot. Align the keyway slot on coupling half (item 8) and slide it into motor shaft. Set coupling half flush with the end of the motor shaft and tighten both set screws with 1/8" Allen wrench to 70 in-lbs. (7.9 N-m).
5. Insert the coupling insert (item 9) into the coupling half on the motor. Carefully slide motor adapter (item 8) end of the column assembly over the motor shaft until both coupling halves are completely seated in the coupling insert. Make sure rabbet (step) on the motor is firmly seated into motor adapter.

⚠ CAUTION: Pump assembly may be top heavy.

6. Rotate the pump and mounting plate to the desired orientation. Align the holes in the mounting plate and the motor adapter with the holes in the motor face. Secure the mounting plate and motor adapter to the motor using (4) washers, lock washers and 3/8" bolts (items 5,6,7) from the hardware package (if metric frame, use (4) 3/8" hex nuts (item 33).
7. Ensure that lock rings are securely snapped in place and did not loosen during shipment.
8. Install the pump into the system according to the installation instructions.

METRIC FRAME

1. Unpack the pump and any supplied accessories and examine for damage. If damage is detected, save the packaging and notify the carrier immediately.
2. Make a hole if required for discharge piping in the optional mounting plate (item 9) at desired location.

3. Prepare to install the motor on the pump. Carefully place the motor on the fan cover on a suitable, level work surface.
4. Install key into motor shaft key slot. Align the keyway slot on coupling half (item 8) and slide it into motor shaft. Set coupling half flush with the end of the motor shaft and tighten both set screws with 1/8" Allen wrench to 70 in-lbs. (7.9 N-m).
5. Install the metric motor adapter flange (item 2) on the motor with (4) socket head cap screws (item 4). Use lock washers (item 3) on 80 frame motors only (90 frame motors do not require any washers). One side of the adapter has a B stamped on it and this side faces the motor on an 80 frame. The other side has an A stamped on it (with hex nut recessed bolt holes). This side (side A) is for 90 frame motors.
6. Proceed to steps 5-8 in section "Pumps without Motors - 56C/143-145TC Frame."

INSTALLATION

The VKC Series is a versatile pump designed to be operated in a variety of mounting configurations. The pump can be mounted either inside or outside of a tank or sump.

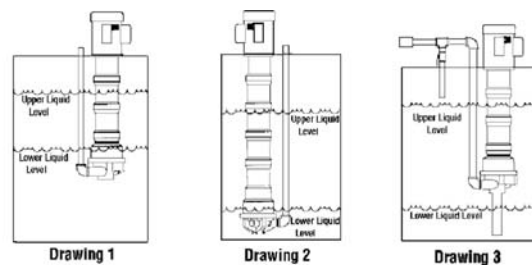
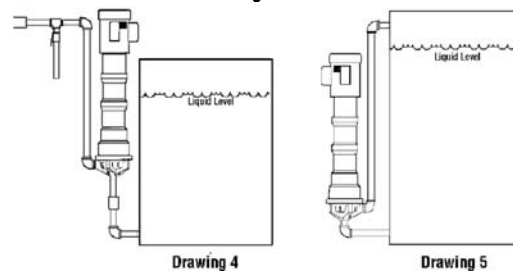

Figure 1



Drawing 1 shows drawing of pump mounted inside a tank with suction off the bottom of the tank and level fluctuating from near top of pump column to close to the bottom of the pump.

Drawing 2 shows drawing of pump suction near tank bottom and level fluctuating between the top and bottom of the tank.

Drawing 3 shows drawing of pump with suction extension and the level fluctuating between start-up level and low level.

Drawing 4 shows drawing of pump mounted outside the tank.

Drawing 5 shows drawing of pump mounted outside the tank with the motor below the liquid level.

Note: Drawings for illustration only. Pumps need to be properly supported when installed.

MOUNTING

A mounting plate is recommended for in tank installations. If required, use a hole saw to cut holes in desired location for piping.

Support and securely fasten the mounting plate on all four sides if possible or on two sides if mounted in a corner. Drill holes in the mounting plate at the desired location for bolting to the tank.

A drip cover may be installed on top of the motor if desired.

Mount pump in desired configuration. Securely fasten mounting plate if used. Motor feet may also be used for mounting.

PIPING

1. Support piping near the pump to eliminate any strain on the pump casings. Do not use suction or discharge piping to support the pump.
2. Do not place the pump suction directly on the bottom of the tank. Keep the pump suction at least one pipe diameter off the bottom.
3. A suction extension tube of up to nine feet in length can be added.
4. To minimize head loss from friction:
Increase pipe size by 1 diameter.
Use minimal number of pipe bends.
5. If a check valve is installed in the discharge piping, an air bleed must be installed in the discharge line to prevent air lock. This allows air trapped in the pump internals to be removed on initial start-up. See drawings 3 and 4 in Figure 1.
6. Maintain a flooded suction. Use a foot valve if necessary.
7. Ensure that the piping does not leak and suction is not prone to clogging. Use a strainer if necessary on the suction.
8. If flexible hose is preferred, use reinforced hose rated for the proper temperature and pressure. This helps avoid collapse or kinks.
9. Install valves a minimum of 10 pipe diameters from the pump.

CAUTION: To stop the pump if prime is lost, use one of the following: (1) pressure switch on the discharge or (2) motor minder to monitor motor current.

ELECTRICAL

Install the motor according to NEC requirements and local electrical codes. Motor should have an overload protection circuit.

Important - To verify correct motor rotation:

1. Install the pump into the system.
2. Fully open the suction and discharge valves.

3. Allow fluid to flow into the pump. Do not allow the pump to run dry (PTFE and ceramic bushings cannot be run dry without damage to pump components).
4. Jog the (allow it to run for 1-2 seconds) and observe rotation of the motor fan. Correct rotation is clockwise as viewed from the motor fan. Refer to directional arrow on pump if needed.

NOTE: A pump running backwards will pump but at a greatly reduced flow and pressure.

OPERATION

1. Completely open discharge valve. On pumps equipped with a discharge check valve, open air bleed valve on initial start-up.
2. Start the pump and check liquid flow. If there is no flow, see the Troubleshooting section.
3. Adjust the flow rate and pressure by regulating the discharge valve.

MAINTENANCE

DISASSEMBLY

1. Disconnect power. Remove electrical wiring.
2. Close discharge valve. Disconnect piping. Remove mounting bolts.
3. Remove pump from tank and place on clean flat surface. Secure the pump motor to the bench.
4. Remove the 5 screws (item 23) from the impeller housing (item 22) and pull the impeller housing and housing o-ring (item 21) off the column assembly.
5. Remove the impeller assembly (items 18, 19 and 20) from the column assembly using the impeller removal tool (item 105157-1) provided.

CAUTION: Keep the impeller assembly away from metal chips or particles.

EXAMINATION

1. Check the impeller drive bushing (item 18), thrust ring (item 20), and shaft for cracks, chips, scoring or excess wear. See Figure 2. Replace as required.

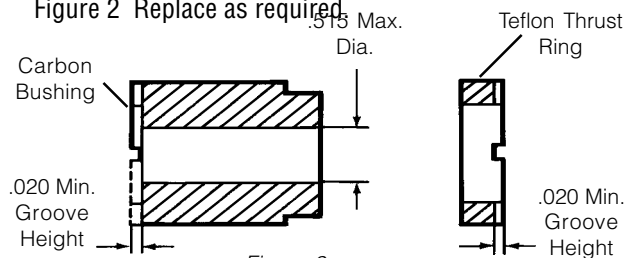

2. Check the rubbed areas on the outside of the impeller, on the inside of the barrier section, and on the inside of the impeller housing. Contact your distributor or FTI Technical Service if a problem is found.

BUSHING AND THRUST RING REPLACEMENT

1. To remove the bushing, place the impeller assembly in an arbor press. Insert a 3/4" diameter plastic or wood shaft through the eye of the impeller and press the bushing out. See Figure 3.

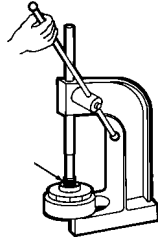

Figure 3

2. To replace the bushing, place the impeller assembly and thrust ring face down into an arbor press. With grooved side up, align the flat on the bushing with the flat in the impeller bore. Press gently making sure the bushing alignment is going in straight. The bushing is correctly installed when the bottom of the bushing (the grooved side) is .855 inches below the bottom of the impeller (end opposite impeller vanes).
3. The impeller thrust ring can be removed from the impeller body by gently pulling the ring from the impeller cover.
4. To replace the thrust ring, align the ring (grooved side up) with the inside of the impeller assembly and press into place.

Note: Protect the thrust ring face with wood or plastic to avoid tilting of the ring.

REASSEMBLY

1. Using the impeller removal tool, carefully reinstall the impeller assembly into barrier section of the column assembly.

⚠ CAUTION: Strong magnets may cause components to slam together. Keep fingers away from area between the impeller and the barrier section during reassembly.

2. Manually spin the impeller to verify there is no internal binding and watch the motor fan spin to verify correct coupling engagement.
3. Install and lubricate the housing o-ring with a chemically compatible lubricant. Install the impeller housing. Align the discharge with the mounting holes on the housing, and insert the screws. Always use thread lubricant when installing new plastic screws. With a screwdriver, carefully tighten all 5 screws following the pattern shown in Figure 4.

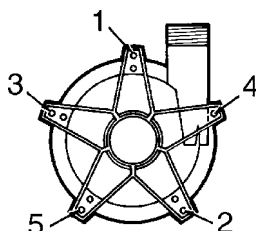

Figure 4

4. Reinstall the pump into the system.

MOTOR REPLACEMENT- REMOVAL

1. Place the pump on the motor fan with the suction pointing up.
2. Note orientation of the mounting plate (if used) to the electrical box for reassembly purposes.
3. Remove the four bolts and washers (items 5, 6, and 7) and pull the pump up off the motor face.
4. If metric motor - remove the four socket head cap screws and washer (items 3 and 4), and remove the metric motor adapter flange (item 2) from the motor face.
5. Remove the coupling insert, loosen the setscrews and remove the coupling half from the motor shaft.

MOTOR REPLACEMENT - INSTALLATION

1. Slide the coupling half (item 8) onto the motor shaft until it is flush with the bottom of the motor shaft. Install the motor shaft key and tighten both setscrews with a 1/8" Allen wrench to 70 in.-lbs. (7.9 N-m).
2. For metric frame, install the metric motor adapter flange (item 2) on the motor with (4) socket head cap screws (item 4). Use lock washers (item 3) on 80 frame motors only (90 frame motors do not require any washers). One side of the adapter (stamped with a "B") fits 80 frame motors, and the other side (with hex nut recessed bolt holes and stamped "A") is for 90 frame motors.
3. Place the coupling insert completely onto the pump shaft coupling half. Install the pump onto the motor face making sure the coupling half on the motor shaft engages completely into the insert.
4. Orientate the mounting plate (if one is used) with the electrical box (as noted during disassembly). Align the bolt holes and install the four bolts with washers (items 5, 6, and 7) through the mounting plate into the motor face. Be sure the pump seats correctly onto the motor face and tighten all of the bolts.
5. Lay the pump on its side and spin the motor fan to verify there is no rubbing, binding or misalignment.

GENERAL NOTES

1. Do not pump liquids containing metal fines.
2. If magnets decouple, stop the pump immediately. The rare earth magnets used in this pump are more resistant to demagnetization, but operating the pump with the magnets decoupled will eventually weaken the magnets.
3. Plastic pumps will expand and contract with temperature so the plastic column sections.
4. An information plate is attached to the mounting plate or motor adapter section. The first line is the model number, and the second line is the serial number. See Figure 5.

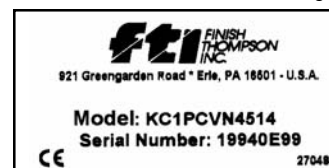
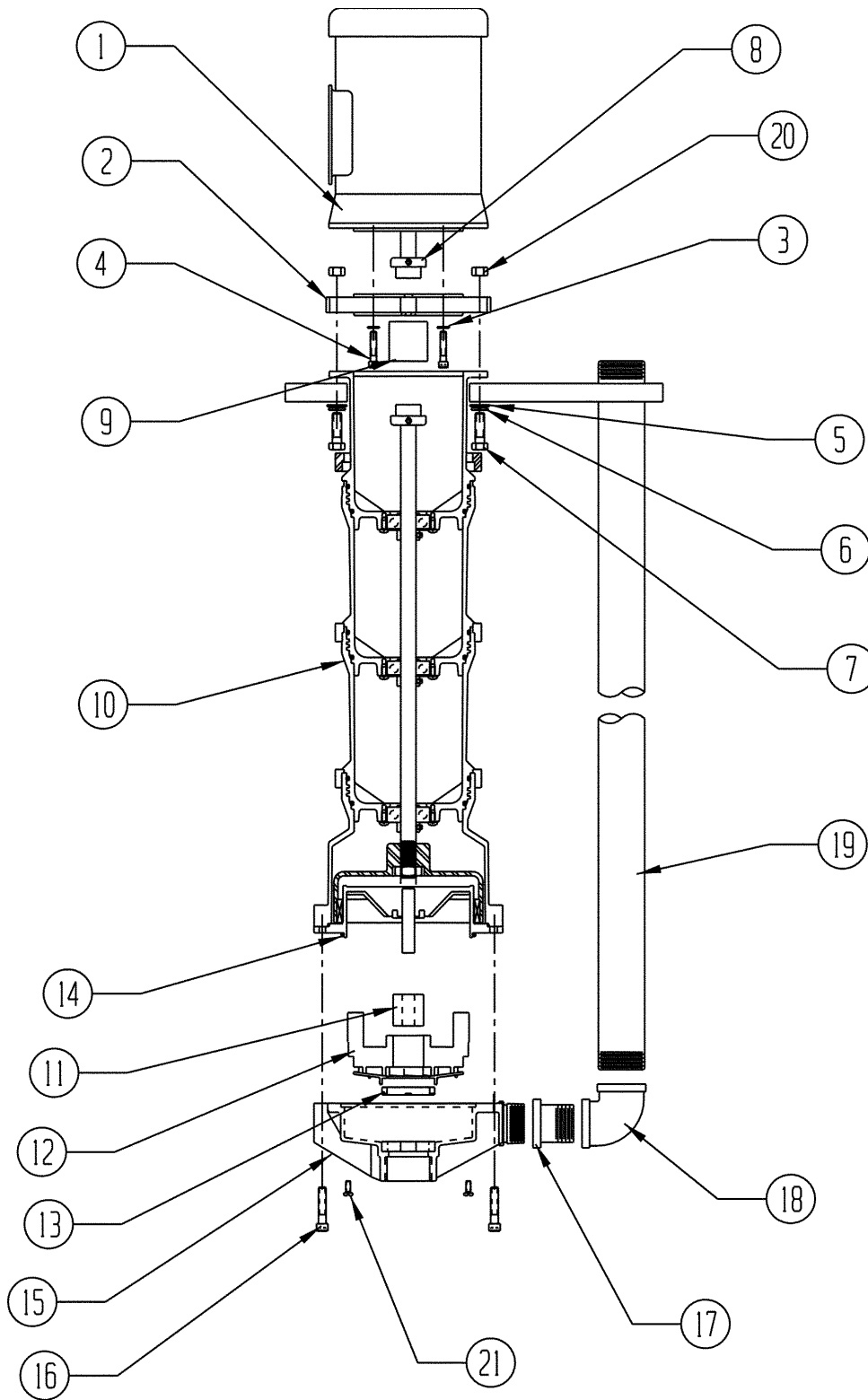

Figure 5

VKC SUMP
Figure 7



VKC 11 PARTS LIST

Item	Qty	Description	Polypropylene Part Number	PVDF Part Number
1	1	Motor	*	*
2	1	Metric Motor Adapter Flange		
		80 frame	M101947	M101947
		90 frame	M101947-1	M101947-1
3	4	1/4" Lock Washer S.S., all metric	J100672	J100672
4	4	Socket Head Cap Screw		
		80 frame	J103228	J103228
		90 frame	J101081	J101081
5	4	3/8" Flat Washer S.S.	J100128	J100128
6	4	3/8" Lock Washer S.S.	J100115	J100115
7	4	3/8" - 16 Hex Hd. Cap Screw		
		56C/143/145TC with mtg. Plate (1-3/4" lg)	J103161	J103161
		56C/143/145TC without mtg. Plate (1" lg)	J100114	J100114
		80/90 frame with mtg. Plate (2-1/4" lg.)	J103227	J103227
		80/90 frame without mtg. Plate (1-1/2" lg.)	J103207	J103207
8	1	Motor Coupling Half		
		56C	J103734	J103734
		143-145TC	J103735	J103735
		80 frame	J103738	J103735
		90 frame	J103740	J103740
9	1	Coupling Insert		
		56C, 143-145TC, 80 frame	J103741	J103741
		90 frame	J103742	J103742
10	1	Call the factory for replacement instructions. Note the model number and serial number.		
11	1	Impeller Bushing, Carbon	J100977	J100977
		Impeller Bushing, PTFE	J100977-1	J100977-1
		Impeller Bushing, Ceramic	J100977-2	J100977-2
12	1	Impeller Assembly with Carbon Bushing and Thrust Ring		
		4-1/2" impeller	A101928(32)	A101936(40)
		4" impeller	A101929(33)	A101937(41)
		3-1/2" impeller	A101930(34)	A101938(42)
		3" impeller	A101931(35)	A101939(43)
12	1	Impeller Assembly with Ceramic Bushing and Thrust Ring		
		4-1/2" impeller	A103106	A103110
		4" impeller	A103107	A103111
		3-1/2" impeller	A103108	A103112
		3" impeller	A103109	A103113
12	1	Impeller Assembly with PTFE Bushing and Thrust Ring		
		4-1/2" impeller	A101932	A101940
		4" impeller	A101933	A101941
		3-1/2" impeller	A101934	A101942
		3" impeller	A101935	A101943
13	1	PTFE Thrust Ring	J101606	J101606
14	1	Impeller Housing O-ring		
		Viton	J102774	J102774
		EPDM	J102775	J102775

*Contact Distributor

VKC 11 PARTS LIST - 2

15	1	Impeller Housing with Ceramic Thrust Ring (NPT)	A101014-1	A101014-2
15	1	Impeller Housing with Ceramic Thrust Ring (BSP)	A101014-4	A101014-5
16	5	Impeller Housing Mounting Screws - Titanium	J103512	J103512
16	5	Impeller Housing Mounting Screws - Hastelloy C	J103536	J103536
17	1	Hex Reducer Bushing 1-1/4" x 1-1/2"	J103191	M102122
18	1	90° Elbow x 1-1/2"	J103165	J103166
19	1	Discharge Pipe		
		12"	M101965-1	M101965-2
		18"	M101965-7	M101965-8
		24"	M101965-3	M101965-4
		30"	M101965-9	M101965-10
		36"	M101965-5	M101965-6
		42"	M101965-11	M101965-12
		48"	M101965-13	M101965-14
		54"	M101965-15	M101965-16
		60"	M101965-17	M101965-18
20	4	3/8"-16 Hex Nut for Metric Adapter Plate	J100135	J100135
21	4	#8 x 5/8" Hi-Low Screws	J101020	J101020

- Due to the hermetically sealed design, the pump will displace liquid as follows:
 Cantilevered = approximately 1 gallon (3.78 liters)
 Sumps = add approximately 1 quart (.95 liters) per column section.
 E.G. 24" sump = 1 1/2 gallons (4.73 liters)

TROUBLESHOOTING

NO DISCHARGE

- Pump not primed.
- Air lock in pump.
- Discharge head too high.
- Closed valve.
- Viscosity or specific gravity too high (magnets uncoupled).

INSUFFICIENT DISCHARGE

- Discharge head higher than anticipated.
- Clogged suction line, foot valve or crimp in hose.
- Foot valve too small.
- Foot valve or suction opening not submerged enough.
- Incorrect pump rotation.

INSUFFICIENT PRESSURE

- Air or gasses in liquid.
- Impeller diameter too small.
- Discharge head higher than anticipated.
- Incorrect pump rotation.

LOSS OF PRIME

- Leaking discharge line.
- Suction lift too high or insufficient NPSHA. Should be 2 feet above NPSHR.
- Air or gasses in liquid.
- Foreign matter in impeller.
- Leaking valve.
- Malfunctioning level sensor or control.

EXCESSIVE POWER CONSUMPTION

- System head is lower than ratings. Pumps too much liquid.
- Specific gravity or viscosity of liquid being pumped is too high or higher than defined in application.
- Binding pump parts.

VIBRATION/NOISE

- Excess bearing wear.
- Drive magnet uncoupled.
- Loose magnet.
- Pump cavitating.
- Motor or piping not properly secured.
- Foreign object in impeller.
- Set screws on motor shaft coupling loose.

WARRANTY

Finish Thompson, Inc (manufacturer) warrants this product to be free of defects in materials and workmanship for a period of 180 days from date of purchase by original purchaser. If a warranted defect, which is determined by manufacturer's inspection, occurs within this period, it will be repaired or replaced at the manufacturer's option, provided (1) the product is submitted with proof of purchase date and (2) transportation charges are prepaid to the manufacturer. Liability under this warranty is expressly limited to repairing or replacing the product or parts thereof and is in lieu of any other warranties, either expressed or implied. This warranty does apply only to normal wear of the product or components. This warranty does not apply to products or parts broken due to, in whole or in part, accident, overload, abuse, chemical attack, tampering, or alteration. The manufacturer accepts no responsibility for product damage or personal injuries sustained when the product is modified in any way. If this warranty does not apply, the purchaser shall bear all cost for labor, material and transportation.

Manufacturer shall not be liable for incidental or consequential damages including, but not limited to, process down time, transportation costs, costs associated with replacement or substitution products, labor costs, product installation or removal costs, or loss of profit. In any and all events, manufacturer's liability shall not exceed the purchase price of the product and/or accessories.

Call our toll free Technical Service Hot Line, 1-800-888-3743, if you have any questions regarding product operation or repair.

ORDERING SPARE PARTS

Spare parts can be ordered from your local distributor. Always refer to pump model number to avoid error.

OTHER FINISH THOMPSON PRODUCTS

Drum Transfer Pumps capable of flows to 40 gpm, discharge head to 80 feet and viscosities to 100,000 cP.

Portable Mixers for turbine mixing and blending in 316 SS.

Centrifugal Pumps in polypropylene, PVDF, 316 SS, and cast iron (ANSI dimensional) are offered in magnetic drive sealless or mechanical seal models.



FINISH THOMPSON INC.

921 Greengarden Road • Erie, PA 16501-1591 U.S.A.
 Ph 814-455-4478 • Fax 814-455-8518
 Email fti@finishthompson.com • www.finishthompson.com

Toll Free Technical Service 800-888-3743
 Part Number J103243, Rev. 5
 Literature I.D. Number FT98-702E, 2/04

