

Split Case Pumps

L, LVM, and JD Series Centrifugal Pumps For High Capacity Commercial, Municipal, And Industrial Applications

Weinman split case pumps meet a wide variety of service needs. The L Series single-stage and LVM vertically mounted pumps provide large capacity general service pumping. Rugged and reliable, they combine mechanical simplicity with sophisticated hydraulic design.

JD Series multi-stage pumps offer reliable, low cost high head pumping for applications such as boiler feed or booster service.

Recognized for their quality, efficiency and economy, Weinman split case pumps meet the design criteria of: ASTM; HI; ANSI; AISI; SAE; and ASME.

	L / LVM	JD
Heads to (ft.)	450	800
Flows to (gal.)	6000	600

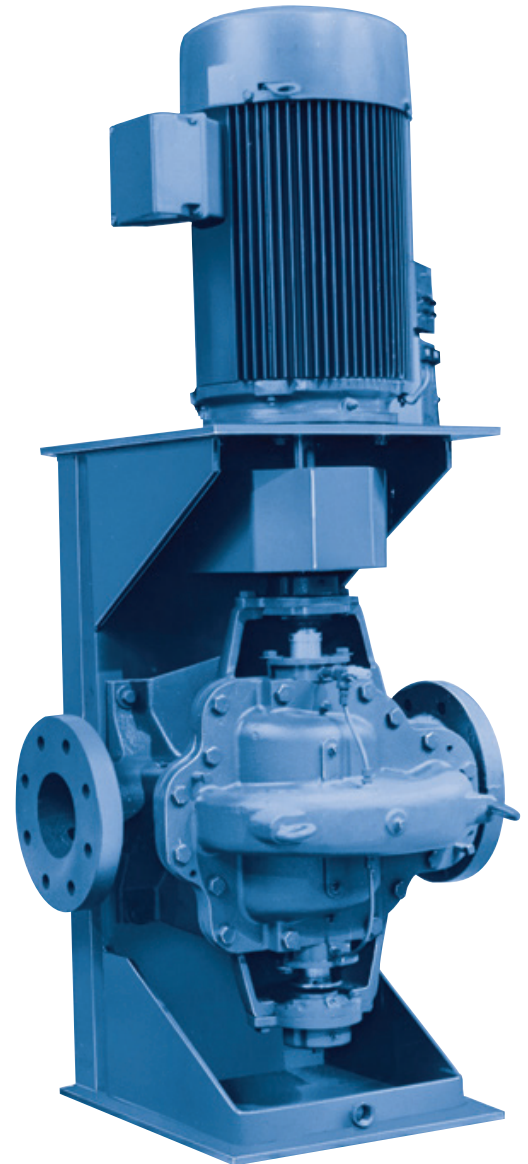
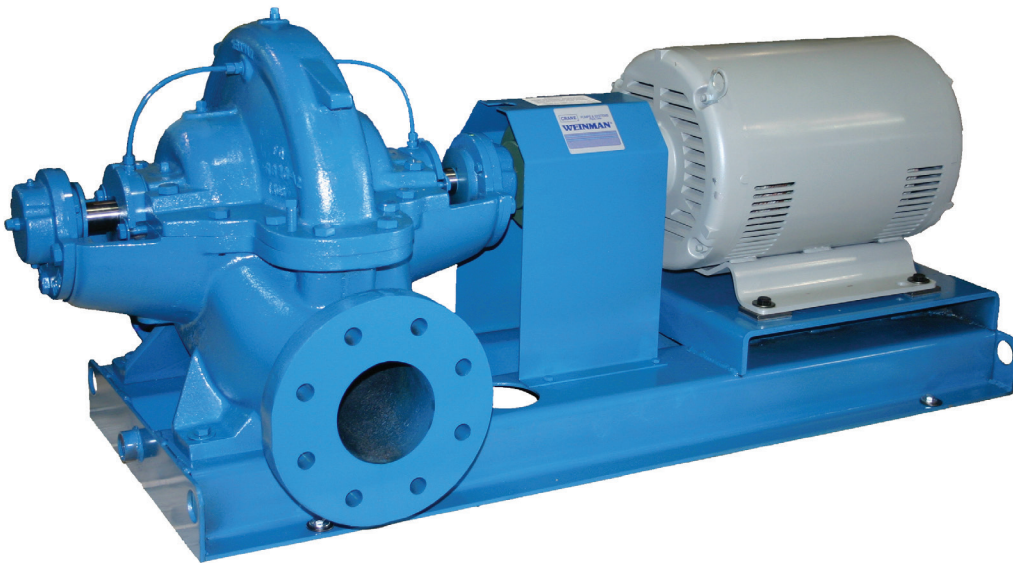

Weinman Split Case Series

L Series

Weinman Single-Stage Split Case Pumps are recommended for large capacity municipal, commercial and general industrial liquid handling applications, including:

- Hot or chilled water circulation
- Pressure boosting
- Cooling tower
- Potable water transmission and treatment
- Boiler feed services requiring high pressure and volume
- General service pumping

Incorporating mechanical simplicity with the latest developments in hydraulic engineering, Weinman L Series horizontally mounted pumps provide higher efficiency, longer pump life and lower cost than comparable pumps.

Extra heavy castings absorb vibration and hydraulic noise thereby assuring smooth and quiet operation. Standard pumps are bronze fitted with iron cases. Optional ductile versions are available. A variety of models offer:

- Discharge sizes from 2" (5 cm) to 12" (30 cm)
- Heads to 450 ft. (137 m)
- Capacities to 6,000 gpm (1363 m³/h)
- Operating pressures to 450 psig (31 bar)

Weinman L Series pumps feature, as standard, a "V" trough base design that collects water from condensation and packing drippage. A connection for drain to waste is provided.

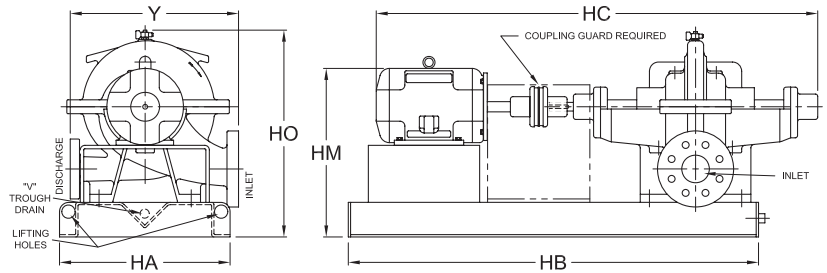

Dimensions									
(All dimensions are approximate and for illustration purposes only. For exact dimensions request certified dimensional prints.)									
Pump Size	Dis.	Inlet	Max. Imp. Dia	Max. HA	Max. HB	Max. HC	Max. HM	HO	Y
2L4	2	3	9 ^{3/4}	20 ^{1/2}	52	62	23	25 ^{1/4}	17
2L5	2	3	14 ^{1/4}	20 ^{1/2}	52	62	23	25 ^{1/4}	20
2L6	2	3	11 ^{1/2}	20 ^{1/2}	52	62	23	25 ^{1/4}	18
3L4	3	4	10	20 ^{1/2}	60	67	24	26	19 ^{1/4}
3L5	3	4	14 ^{1/4}	20 ^{1/2}	60	67	24	26	22 ^{1/2}
3L6	3	4	11 ^{1/2}	20 ^{1/2}	52	62	23	25 ^{1/4}	21
4L1	4	5	14	20 ^{1/2}	60	67	24	26	26
4L2	4	5	11	20 ^{1/2}	52	62	23	25 ^{1/4}	24 ^{1/2}
4L3	4	5	8	20 ^{1/2}	52	62	23	25 ^{1/4}	20 ^{1/2}
4L4	4	6	9 ^{1/2}	22 ^{1/2}	60	71	27	28	21 ^{1/2}
5L1	5	6	14 ^{3/4}	22 ^{1/2}	60	71	27	28	30 ^{1/2}
5L2	5	6	12	20 ^{1/2}	60	67	24	26	26
5L3	5	6	8 ^{3/4}	20 ^{1/2}	52	62	23	25 ^{1/4}	23 ^{1/2}
6L1	6	8	16	28 ^{1/2}	68	78	30	31	33
6L2	6	8	12	22 ^{1/2}	60	67	25	28	28 ^{1/2}
6L3	6	8	9	20 ^{1/2}	60	67	24	26	27 ^{1/2}
6L7	6	8	20	28 ^{1/2}	80 ^{1/2}	83 ^{7/8}	31	32 ^{3/4}	31
8L1	8	10	16	28 ^{1/2}	72	83	33	40	36
8L2	8	10	12 ^{1/4}	28 ^{1/2}	68	78	30	31	34
8L3	8	10	10	22 ^{1/2}	60	69	26	28	32
8L7	8	10	17	28 ^{1/2}	80 ^{1/2}	83 ^{7/8}	31	32 ^{3/4}	29
8L8	8	10	20	28 ^{1/2}	80 ^{1/2}	83 ^{7/8}	33 ^{1/2}	34 ^{3/4}	32
10L2	10	12	14	28 ^{1/2}	76	86 ^{1/4}	33	37 ^{1/4}	40
10L3	10	12	11 ^{3/4}	28 ^{1/2}	68	80	31	35	36 ^{1/2}
10L7	10	12	14 ^{1/2}	28 ^{1/2}	80 ^{1/2}	83 ^{7/8}	33 ^{1/2}	34 ^{3/4}	35
10L8	10	12	16 ^{1/2}	28 ^{1/2}	80 ^{1/2}	83 ^{7/8}	33 ^{1/2}	34 ^{3/4}	37
12L2	12	12	13 ^{1/2}	28 ^{1/2}	72	83	33	40	40

Dimensions are in inches.

Weinman's Split Case LVM Series pumps provide the same reliable performance as the L Series. Its vertical design occupies less space than horizontal pumps, making installation easier, especially in small or restricted areas. The improved design also makes it easier to perform routine maintenance. The pumps use three-phase motors from 1 hp (.75 kW) through 400 hp (300 kW) that deliver heads to 450 ft. (137 m) and capacities to 6,000 gpm (1363 m³/h).

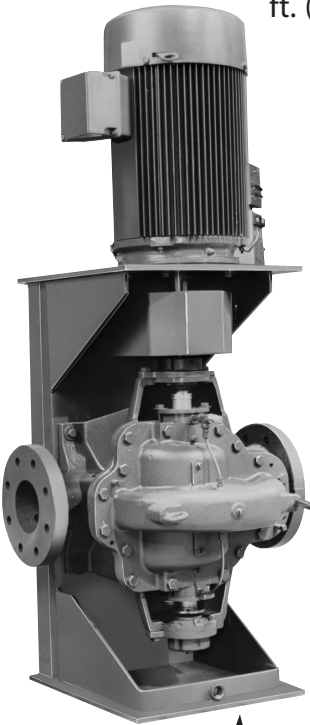

LVM Thrust Bearing Configuration for Type LVM1-LVM6

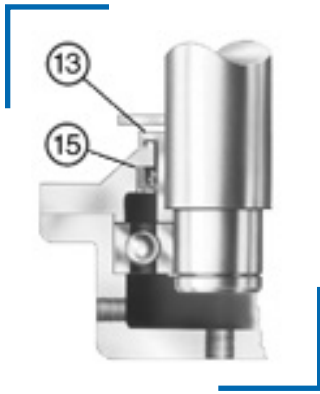

DRIP BASE DRAIN

Features

- A separate, adjustable motor mounting plate can be doweled into place by the installer after coupling is aligned in field to ensure accurate, lasting alignment.
- The pump is permanently bolted and doweled to the base at the factory to prevent pump movement and misalignment.
- A spacer-type coupling is standard and allows removal of the rotating element without removing motor.
- A thrust collar sleeve (13) prevents the rotating assembly from dropping if a bearing should fail. A lip seal (15) prevents liquid from entering the lower bearing housing.
- Lifting holes placed in the top and side of the base make lifting and installation easier.

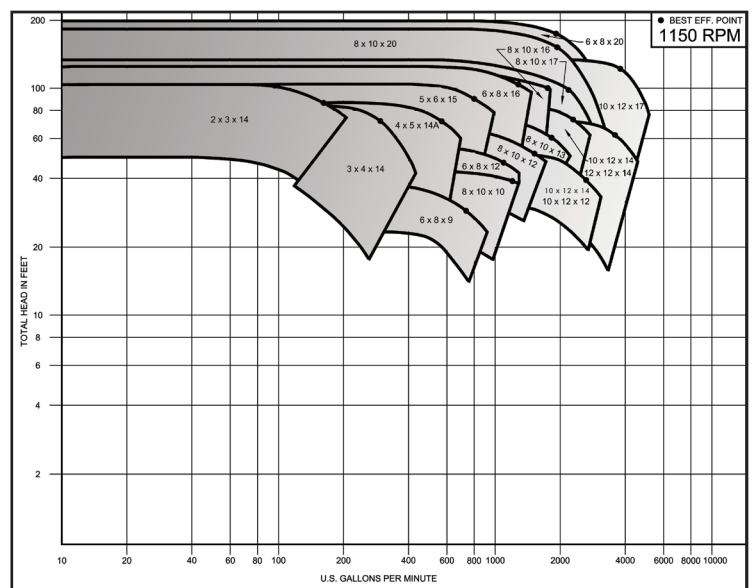
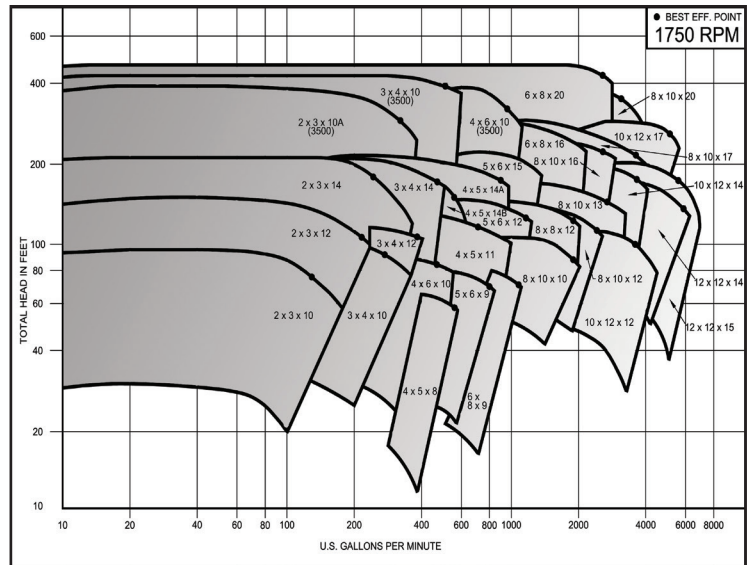
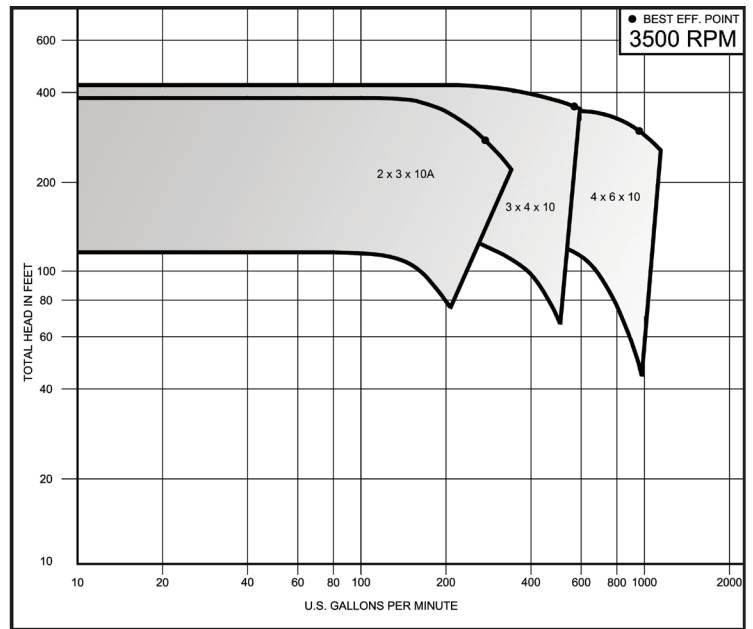

JD Series - Performance Curves and Dimensions

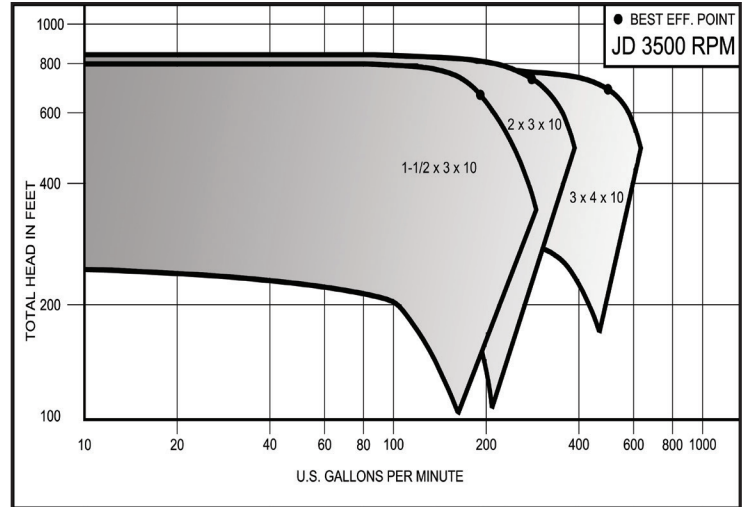
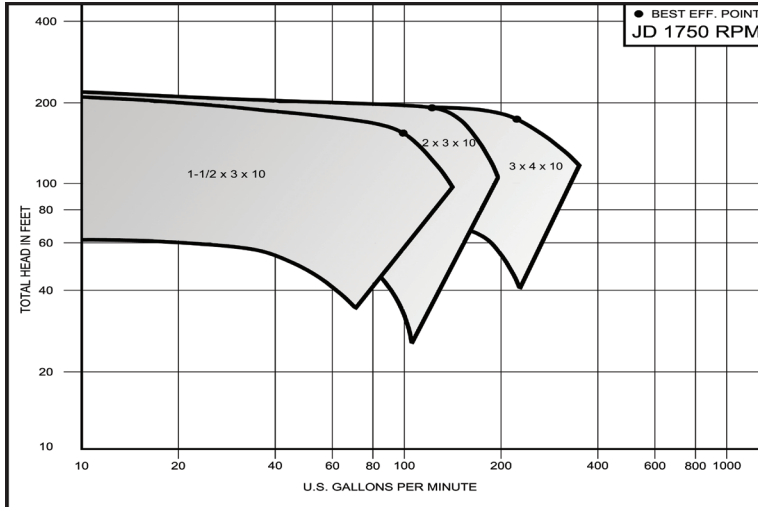

Dimensions											
(All dimensions are approximate and for illustration purposes only. For exact dimensions request certified dimensional prints.)											
Type 1 1/2 JD, Oil Lubricated Bearing											
Max. HP		Dis.	Inlet	Max. Imp. Dia	Max. HA	Max. HB	Max. HC	Max. HM	HO	Y	
3500	1750										
	15	1 1/2	3	10	20 1/2	54 1/2	56	20 5/8	22 1/2	20 3/4	
	125	1 1/2	3	10	24 1/2	54 1/2	66 5/8	23 1/2	22 1/2	20 3/4	
Type 2 JD, Oil Lubricated Bearing											
	15	2	3	10	20 1/2	54 1/2	56	20 5/8	22 1/2	23	
	125	2	3	10	24 1/2	54 1/2	66 5/8	23 1/2	22 1/2	23	
Type 3 JD, Oil Lubricated Bearing											
	20	3	4	10	20 1/2	54 1/2	58 5/8	20 5/8	24	23 3/4	
	150	3	4	10	24 1/2	54 1/2	70	25 1/8	24	23 3/4	

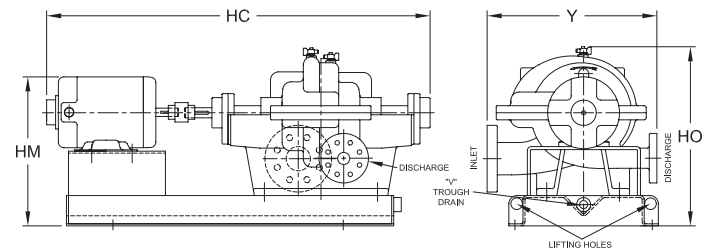

A Crane Co. Company

PUMPS & SYSTEMS

Crane Pumps & Systems
420 Third Street
Piqua, Ohio 45356
(937) 778-8947
Fax (937) 773-7157
www.cranepumps.com

Crane Pumps & Systems Canada
83 West Drive
Brampton, Ont. Canada L6T 2J6
(905) 457-6223
Fax (905) 457-2650

© 2014 Crane Pumps & Systems, Inc.
A Crane Co. Company
Printed in U.S.A.
W1100-1200-1310BRO - Rev. C (7/14)



brands you trust.

BARNES®

burks®

DEMING®

WEINMAN®



PROSSER®