

MAGNETICALLY COUPLED



- Miniature Precision PD Pumps

 **Tuthill**

Engineered Solutions

MAGNETICALLY COUPLED PUMPS

Since 1977, Tuthill has worked to improve magnetically driven gear pumps by engineering solutions to meet the needs of varying applications and exacting designer specifications. The result is a family of magnetically coupled pumps that have found wide industry acceptance for their versatility and robust standard of build and reliability.



TUTHILL MAGNETICALLY COUPLED PUMPS –

Perfect for Technically Precise & Demanding Applications!

The magnetically coupled construction requires no packing or mechanical seals. This also means there are no diaphragms or plastic tubes to rupture, making them leak free.

The external gear design offers flow that is relatively independent of pressure providing constant fluid delivery with no pulsations and controlled volume that is accurate and repeatable, making it highly suitable for metering applications. And it can meet these demands in circumstances with high differential pressures and high system pressures, as well as thin to moderate viscosity fluids.

Quality 316 stainless steel, hastelloy, titanium, or engineered plastics construction with engineered plastic gears and bearings provides excellent resistance to chemicals and corrosive fluids.

These features provide long life and, combined with efficient modular design, offer low maintenance and easy low-cost installation and start-up.

Pumps are Magnetically Coupled to a RANGE OF STANDARD MOTORS.

The pumps are designed to operate at 2-pole and 4-pole motor speeds, eliminating the need for gear reducers. The flow can be easily and precisely controlled by using standard AC, DC, BLDC, and air motors and controllers. AC motors are available in local voltage/frequency combinations, either single or three phase. The pumps can be adapted to IEC and NEMA motors, including Explosion Proof designs. Variable Speed Drives are available.

CHEMICAL RESISTANT METALS

A vast knowledge of magnet, pump, and motor technology is utilized in the design, manufacturing, and application of our magnetically coupled pumps. The long life and non-pulsing flow of the external gear design are combined with the magnetically coupled, leak-free, seal-less construction. Temperatures to 350°F (176°C) and viscosities from 0.3 cps to over 10,000 cps make this pump tough and reliable.

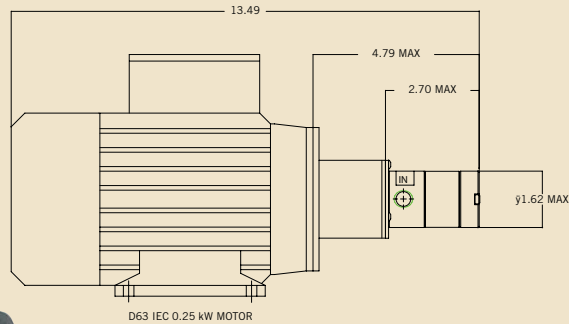

D SERIES

- Flow rates from 1 ml/min to 121 gph (458 L/hr)
- Differential pressures to 250 psi (17.2 bar)
- ATEX approved

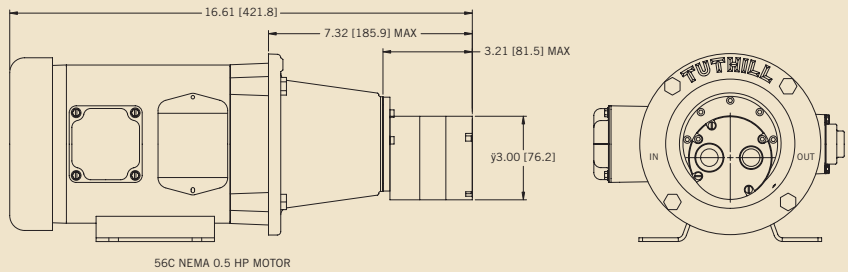
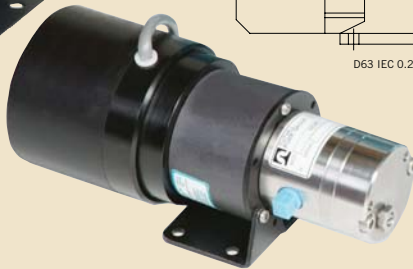

T SERIES

- Flow rates from 5 to 650 gph (2460 L/hr)
- Differential pressures to 250 psi (17.2 bar)
- ATEX approved

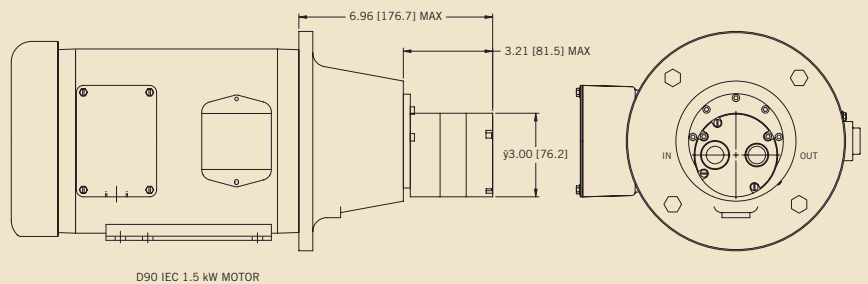

ENGINEERED PLASTIC ALTERNATIVES

These magnetically coupled pumps are constructed with Polyphenylene Sulfide (PPS), a highly durable engineered plastic. They produce non-pulsing flow rates to 65 gph (245 L/hr) at temperatures to 150° F (65° C) providing a versatile and durable solution.

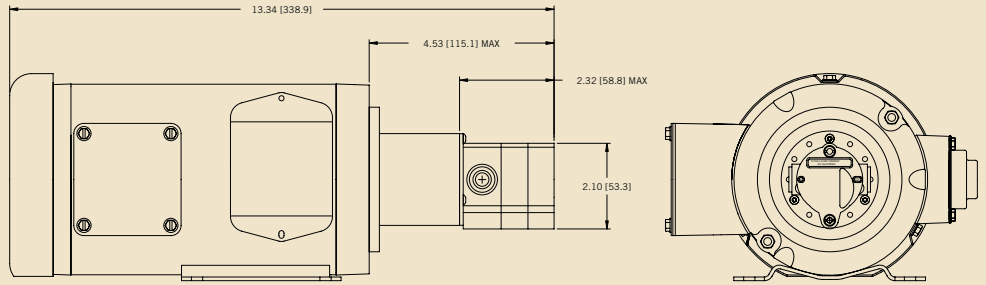

D63 IEC 0.25 kW MOTOR

P SERIES

- External gear pump
- Differential pressures to 150 psi (10.3 bar)
- Viscosities from 0.3 cps to over 10,000 cps
- Flows to 65 gph (227L/hr)



V SERIES

- Vane Pump design (*Patent Pending*)
- Differential pressures to 60 psi (4 bar)
- Viscosities from 0.3 cps to 100 cps
- Flows to 1 gpm (3.8 lpm)

MARKETS AND APPLICATIONS

- Medical Equipment
- Laser Cooling
- Water Purification
- Laboratory Equipment
- Chemical Metering
- Semiconductor Equipment
- Liquid Chromatography
- Industrial Inkjet Printers
- Temperature Control
- Water Treatment
- Waste Water Treatment
- Agriculture
- Food and Beverage
- Analytical Equipment

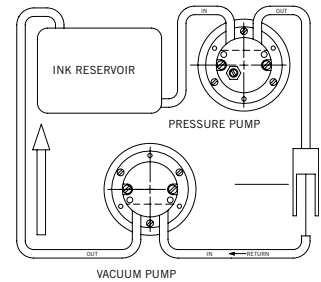

TYPICAL INKJET APPLICATION

MATERIALS OF CONSTRUCTION

MODEL	P-SERIES	D-SERIES	T-SERIES
WETTED COMPONENTS	PPS with 316 SS, HASTELLOY or TITANIUM TRIM	316 SS, HASTELLOY or TITANIUM	316 SS, HASTELLOY or TITANIUM
GEARS	PPS	PPS, PEEK, or LCP	PPS or PEEK
BEARINGS	PPS	PPS, PEEK, or LCP	PPS or PEEK
O-RINGS	VITON, EPR, NITRILE, or NEOPRENE	VITON, PTFE, EPR, NITRILE, or NEOPRENE	VITON, PTFE, EPR, NITRILE, or NEOPRENE
MAGNETS	ENCAPSULATED CERAMIC or SAMARIUM COBALT	ENCAPSULATED CERAMIC or SAMARIUM COBALT	ENCAPSULATED SAMARIUM COBALT

316 SS: 316 Stainless Steel

PPS: Polyphenylene Sulfide

PEEK: PolyEtherEtherKetone

MAGNETICALLY COUPLED PUMPS

Pumps offer **LEAK-FREE, SEAL-LESS CONSTRUCTION**, constant delivery and versatility.

These pumps are known for their magnetically coupled, leak-free, seal-less construction and the non-pulsing flow of their external gear design. This makes them perfect for demanding applications such as medical equipment, laboratory equipment, chemical metering, laser cooling and industrial temperature control. If it requires a seal free, technically advanced pump, Tuthill Magnetically Coupled Pumps are the solution.

WORKING PRINCIPLE

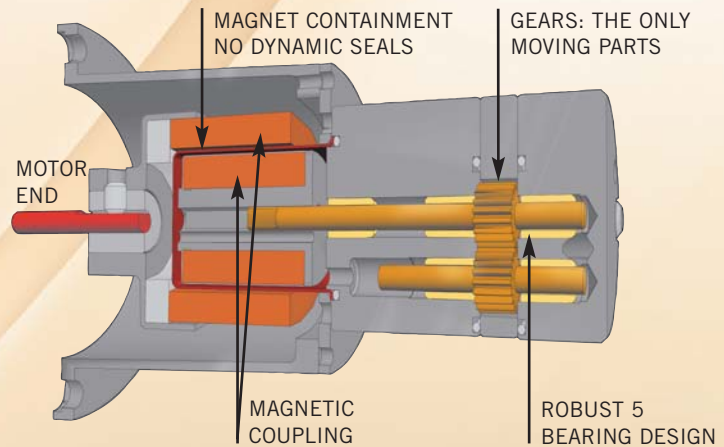

PERFORMANCE RANGE OF FLOWS & PRESSURE

SIZE	PUMP	CONT. MAXIMUM SPEED	MAXIMUM DIFFERENTIAL PRESSURE				MAXIMUM TEMPERATURE		FLOW @ 0 PRESSURE	
			INTERMITTENT		CONTINUOUS				3500 RPM	2900 RPM
ml/rev	SERIES	RPM	PSI	BAR	PSI	BAR	°F	°C	US GPH	LPH
.11	D	5000	250	17.2	250	17.2	350	177	5.8	18
.19	D	5000	250	17.2	250	17.2	350	177	10.0	31
.23	D	5000	250	17.2	250	17.2	350	177	12.1	38
.38	D	5000	250	17.2	250	17.2	350	177	20.0	63
.57	D	5000	250	17.2	250	17.2	350	177	30.0	94
.68	D	5000	250	17.2	200	13.8	350	177	35.8	112
.80	D	5000	250	17.2	200	13.8	350	177	42.2	132
.99	D	5000	200	13.8	140	9.7	350	177	52.2	164
1.2	D	5000	200	13.8	140	9.7	350	177	63.2	198
1.3	D	5000	175	12.1	125	8.6	350	177	69.0	215
1.6	D	5000	150	10.3	100	6.9	350	177	84.0	264
2.0	D	5000	150	10.3	100	6.9	350	177	105.0	331
2.3	D	5000	150	10.3	100	6.9	350	177	121.0	380
2.6	T	5000	250	17.2	150	10.3	350	177	137.0	430
5.3	T	5000	135	9.3	100	6.9	350	177	279.4	876
7.9	T	4000	90	6.2	70	4.8	350	177	416.4	1306
8	T	4000	150	10.3	150	10.3	350	177	421.7	1343
12	T	4000	100	6.9	100	6.9	350	177	642.5	2015
.38	P	4000	150	10.3	150	10.3	150	66	20.0	63
.57	P	4000	150	10.3	130	9.0	150	66	30.0	94
.68	P	4000	150	10.3	110	7.6	150	66	35.8	112
1.2	P	4000	150	10.3	90	6.2	150	66	63.2	198



www.tuthillpump.com

To find an authorized distributor,
visit www.tuthillpump.com/distributors

Tuthill Pump Group
5143 Port Chicago Highway
Concord, California 94520 USA
phone: 925-676-8000 / fax: 925-676-8151
email: concord@tuthill.com

Tuthill Pump Group
12500 South Pulaski Road
Alsip, Illinois 60803 USA
phone: 708-389-2500 / fax: 708-388-0869
email: tuthillpump@tuthill.com

Tuthill Pump Group
Birkdale Close
Manners Industrial Estate
Ilkeston, Derbyshire DE7 8YA England
phone: 44.115.932.5226 / fax: 44.115.932.2526
email: tuthillpumpuk@tuthill.com

Tuthill Europe
Parc industriel Wavre Nord
Avenue Vésale, 30 - 1300 Wavre - Belgium
phone: 32 10 22 83 34 / fax: 32 10 23 82 40
email: tld@tuthill.com

Tuthill Latin America
255 Alhambra Circle, Suite 320
Coral Gables, Florida 33134 USA
phone: 305-740-3381 / fax: 305-740-9328
email: tuthill.latinamerica@tuthill.com

Tuthill Australia
19/21 Milton Park, 128 Canterbury Road
Kilsyth, Victoria, 3137, Australia
phone: 61 3 9720 6533 / fax: 61 3 9720 6880
email: asiapacific@tuthill.com.au

Tuthill China
Room 1507, Harbour Ring Plaza
No. 18 Xizang Zhong Road
Shanghai, 200001, P.R. China
phone: 86 21 53853369 / fax: 86 21 53853365
email: china@tuthill.com.cn

Engineered Solutions