



# ROTARY GEAR PUMPS

## THE FEED PUMP TYPE T

### The various types of the Feed Pump T

type  
T

- pulsation-free pumping delivery
- independent of sense of rotation
- sturdy construction
- easy mounting
- wide selection of materials
- several sealing variants
- for packings with suction bore

type  
TM

- fully enclosed heater jackets
- heatable with thermal oil, water or steam
  - heating temperature up to 320 °C
  - pressure up to 8 bar max.
- DIN flange connection or screw thread

type  
TE  
TFE

- electric heating of end cover plate
- heatable via four cartridge-type heaters controlled by a system thermostat adjustable from 0 to 300 °C

type  
TA  
TMA

- pumps abrasive and pigment-containing media
- gearing outside the pump
- fully sealed anti-friction bearings
- highly wear-resistant rotary shaft seal

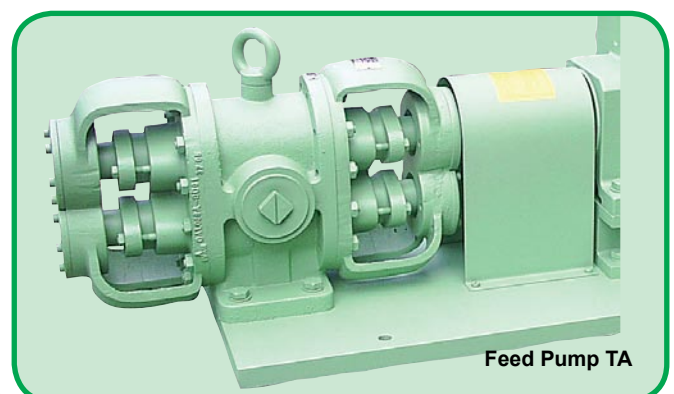
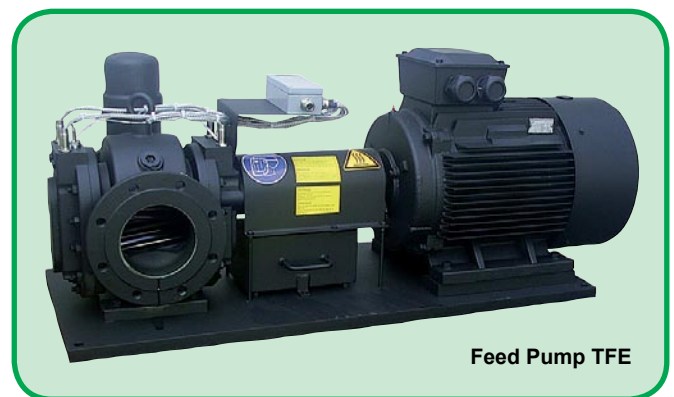
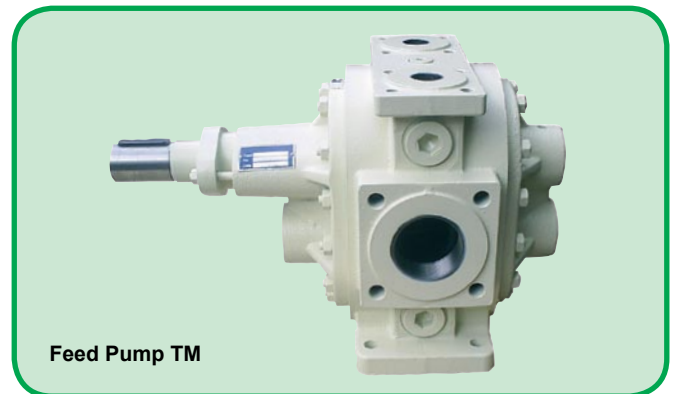

### Pumping media (selection)

Bitumen • tar • binders • paints • varnishes  
solvents • glues • adhesives • resins • plastics  
polyols • plasticizers • waste oil • engine oil  
heavy fuel oil • lubrication oil • wax and foodstuffs  
fats • cacao butter • cacao mass • chocolate •  
molasses • waffle dough and fruit pulp • glucose  
syrops • and many more

### Basic data

Flow rate 15 - 1,500 cm<sup>3</sup> / rev

Pressure 16 bar  
(higher pressures on request)

Viscosity range up to 80,000 cP

## Basic features

With the series type T we offer a program with several variants and constructions **for the transport of almost all pumpable media**.

It can be used up to maximum rotational speeds of 1500 rpm at pressures up to 16 bar. The rotational speed is basically determined by the viscosity or lubricity of the pumped medium.

At viscosities in excess of 10000 mm<sup>2</sup>/s the medium to be pumped should flow to the pump. In case of suction heights of more than 7 m LC and admission pressures in excess of 2 bar please contact our engineering department as larger piping cross sections will be required!

The pumps are driven by electric motors, backgeared motors, belt drives adjustable gear motors, or similar.

All pumps can operate with clockwise or counter-clockwise sense of rotation. Please indicate the required sense of rotation in your purchase order. Slight peaks may be produced in all pumps with drive shaft positioned below. Here it must be taken into account that the direction of delivery flow will change.

Nearly all construction types and sizes of pumps can be provided with a built-in, adjustable pressure relief valve. We also offer separate pressure relief valves to be inserted into the pipeline!

## Materials

<b>Grey cast iron</b>	Pump body parts: Shafts, gearwheels: Bearings: Stuffing box packing:	grey cast iron (EN-GJL-250/GG 25, GGG 40, GS 45) case hardened steel (16 Mn Cr S5) special-type bronze AW Buramex SF free of silicone
<b>Zinc-free bronze</b>	Pump body parts: Shafts, gearwheels: Bearings: Stuffing box packing:	zinc-free cast bronze (G-Cu-Sn10 / GBz10) stainless steel (1.4462) zinc-free Bronze (CuSn 10 / GBz 10) Buramex SF free of silicone
<b>Stainless steel</b>	Pump body parts: Shafts, gearwheels: Bearings and wearings disks: Stuffing box packing:	stainless steel (1.4581) stainless steel (1.4462) artificial carbon, Ceramic, Bronze Buramex SF free of silicone
Other materials, seals or special designs upon request.		

## Range of applications

General engineering, construction, coating machine manufacturers, bitumen processing, chemical industry, paint industry, printing ink industry, foil manufacture, foodstuff such as chocolate production and other, food processing, cardboard and plastic processing machines, paper manufacturers, chipboard production and the automotive industry amongst many other industries.

## Application in ATEX range



We supply gear pumps according to **EC-directive 94/9/EC (ATEX 95)**.

Equipments for zone 1 + 2 (II2G / D T3 und T4), which ensure a high level of safety. Designed for the case, it is to be counted on an explosive atmosphere. **Shaft sealing (G + GGK) with temperature monitoring.**

Equipments for zone 2 + 22 (II3G / D T3), which ensure a normal level of safety. Designed for the case, it is to be counted on an explosive atmosphere rather rarely and if so, only for a short time. **Shaft sealing (P + G) without temperature monitoring.**

## Codes of designs

### Designs

<b>T</b>	standard model
<b>TF</b>	casing with DIN (ANSI) flange connections
<b>S</b>	support bearing for belt drive
<b>A</b>	external antifriction bearing
<b>Z</b>	external gears
<b>E</b>	electrical heating
<b>M</b>	heating jacket
<b>DG</b>	pressure relief valve in casing
<b>DD</b>	pressure relief valve in cover
<b>DDM</b>	pressure relief valve with heating jacket
<b>GKM</b>	bedplate, coupling, motor
<b>GKGM</b>	bedplate, coupling, gear motor

### Shaft sealing

<b>P</b>	stuffing box packing
<b>G</b>	mechanical seal (GLRD)
<b>GP</b>	mechanical seal with secondary safety stuffing box packing
<b>GGK</b>	double mechanical seal (back-to-back) with quench or buffer fluid

## Order example

**T 10-240/GDD-GKM**

<b>T</b>	Type (design)
<b>10</b>	size
<b>240</b>	size, gear width (mm)
<b>G</b>	with mechanical shaft seal
<b>DD</b>	with pressure relief valve in cover
<b>GKM</b>	bedplate, coupling, motor

# Pump capacities

Pump size	Pump capacity Rated power	Pressure p (bar) at rotational speed n = 500 1/min					Pressure p (bar) at rotational speed n = 700 1/min					Pressure p (bar) at rotational speed n = 950 1/min					Pump capacity cm <sup>3</sup> /r
		2	4	6	8	10	2	4	6	8	10	2	4	6	8	10	
T 0-36	l/min	7,0	6,7	6,5	6,2	6,0	10,0	9,5	9,0	8,5	8,0	13,5	13,0	12,5	12,0	11,5	15
	NkW	0,12	0,15	0,18	0,21	0,24	0,13	0,17	0,21	0,25	0,29	0,14	0,16	0,23	0,28	0,33	
	Motor <sup>1</sup> kW	0,25	0,25	0,25	0,37	0,37	0,25	0,25	0,37	0,37	0,37	0,25	0,25	0,37	0,37	0,55	
T 1-60	l/min	12,5	11,5	11,0	10,5	10,0	16,5	16,0	15,5	15,0	14,5	23,0	22,0	21,0	20,0	19,0	25
	NkW	0,15	0,19	0,24	0,29	0,33	0,15	0,20	0,27	0,33	0,39	0,25	0,33	0,40	0,48	0,55	
	Motor <sup>1</sup> kW	0,25	0,25	0,37	0,37	0,55	0,25	0,37	0,37	0,55	0,55	0,37	0,55	0,55	0,75	0,75	
T 2-70	l/min	19,0	18,5	18,0	17,5	17,0	26,5	26,0	25,5	25,0	24,5	36,0	35,0	34,0	33,0	32,0	40
	NkW	0,21	0,26	0,32	0,37	0,42	0,25	0,33	0,40	0,48	0,55	0,30	0,42	0,55	0,68	0,80	
	Motor <sup>1</sup> kW	0,37	0,37	0,55	0,55	0,55	0,37	0,55	0,55	0,75	0,75	0,55	0,55	0,75	1,1	1,1	
T 3-80	l/min	29	28	27	26	25	40	39	38	37	35	55	54	53	52	51	60
	NkW	0,26	0,36	0,44	0,53	0,63	0,40	0,55	0,70	0,85	1,0	0,6	0,8	1,0	1,2	1,4	
	Motor <sup>1</sup> kW	0,37	0,55	0,55	0,75	0,75	0,55	0,75	1,1	1,1	1,5	0,75	1,1	1,5	1,5	2,2	
T 4-95	l/min	52	51	50	49	48	72,5	71,5	70,0	68,5	67,0	98	97	95	93	91	108
	NkW	0,60	0,77	0,95	1,12	1,29	0,70	1,00	1,30	1,60	1,80	0,80	1,20	1,50	1,90	2,30	
	Motor <sup>1</sup> kW	0,75	1,1	1,5	1,5	2,2	1,1	1,5	2,2	2,2	3	1,1	1,5	2,2	3	3	
T 6-80	l/min	66	65	64	63	62	92,5	91,0	89,5	88,0	86,5	126	124	122	120	118	135
	NkW	0,8	1,0	1,2	1,4	1,6	0,9	1,2	1,5	1,8	2,2	1,2	1,7	2,1	2,7	3,1	
	Motor <sup>1</sup> kW	1,1	1,5	1,5	2,2	2,2	1,1	1,5	2,2	3	3	1,5	2,2	3	4	4	
T 6-110	l/min	90	89	88	87	86	126	124,5	123	121,5	120	171	169	167	165	163	182
	NkW	1,0	1,3	1,6	1,9	2,2	1,2	1,7	2,1	2,7	3,1	1,5	2,1	2,8	3,5	4,1	
	Motor <sup>1</sup> kW	1,5	2,2	2,2	3	3	1,5	2,2	3	4	4	2,2	3	4	5,5	5,5	
T 8-100	l/min	123	122	121	120	119	172	171	170	169	167	234	223	230	228	226	250
	NkW	1,15	1,5	2,0	2,4	2,8	1,5	2,1	2,8	3,5	4,1	2,2	3,1	4,0	4,9	5,8	
	Motor <sup>1</sup> kW	1,5	2,2	3	3	4	2,2	3	4	5,5	5,5	3	4	5,5	7,5	7,5	
T 8-140	l/min	180	178	176	173	170	252	249	246	242	238	342	338	334	329	323	364
	NkW	1,6	2,2	2,8	3,4	4,0	2,3	3,2	4,1	5,0	6,1	3,2	4,5	5,8	7,1	8,4	
	Motor <sup>1</sup> kW	2,2	3	4	5,5	5,5	3	4	5,5	7,5	7,5	5,5	7,5	7,5	11	11	
T 10-120	l/min	246	242	239	234	230	344	339	334	328	322	466	460	453	445	437	500
	NkW	2,3	3,2	4,1	5,0	6,1	3,2	4,5	5,3	7,1	8,4	4,4	6,2	8,0	9,8	11,6	
	Motor <sup>1</sup> kW	3	4	5,5	7,5	7,5	5,5	7,5	7,5	11	11	7,5	11	11	15	15	
T 10-240	l/min	496	490	483	476	468	694	686	676	666	655	942	931	917	904	889	1.000
	NkW	4,6	6,5	8,3	10,3	12,2	6,4	9,1	11,6	14,4	17,0	8,7	12,3	15,7	19,5	23,1	
	Motor <sup>1</sup> kW	5,5	7,5	11	15	15	7,5	11	15	18,5	22	11	15	22	30	30	
T 11-240	l/min	745	735	725	715	705	1.043	1.029	1.015	1.001	987	1.415	1.396	1.377	1.356	1.340	1.500
	NkW	7,0	9,7	12,5	15,5	18,4	9,7	13,6	17,4	21,6	25,7	13,0	18,4	23,6	29,3	34,7	
	Motor <sup>1</sup> kW	11	15	15	18,5	22	15	18,5	22	30	30	18,5	22	30	37	45	

NkW = nominal power requirement at the pump shaft related to a viscosity of 50 to 150 mm<sup>2</sup>/sec (cSt).

The pump capacity (l/min) is related to 500, 700 and 950 1/min. It will be reduced as a function of the rated speed of the motor.

Variation of the delivery output: ±5%.

The pump capacity will also be reduced at a viscosity of less than 50 mm<sup>2</sup>/sec.

<sup>1</sup> Driving power required (20% additional extra are included).

Subject to change.

# Details in sectional view

Abbreviations see page 2, codes of designs.

Design T with stuffing box packing P

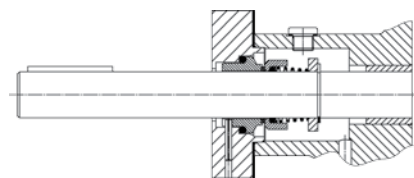
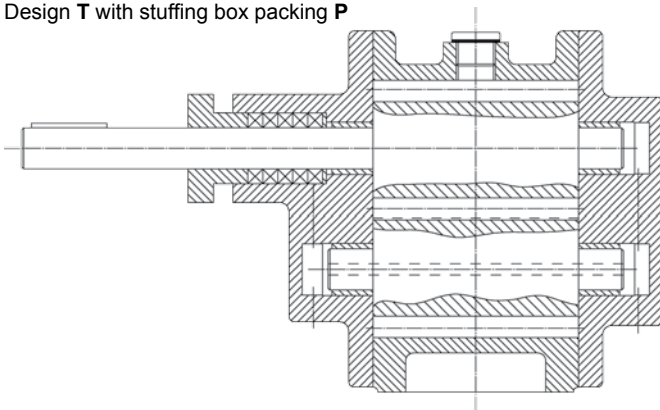

Shaft sealing G

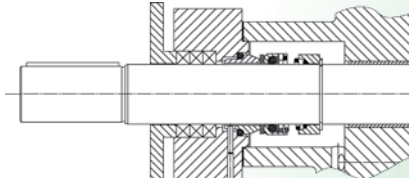

Shaft sealing GP  
(typ. application: bitumen processing)

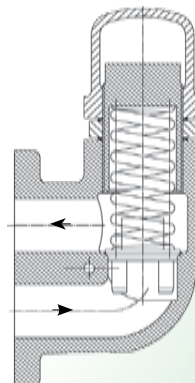

Pressure relief valve DD  
(build in counter-cover)

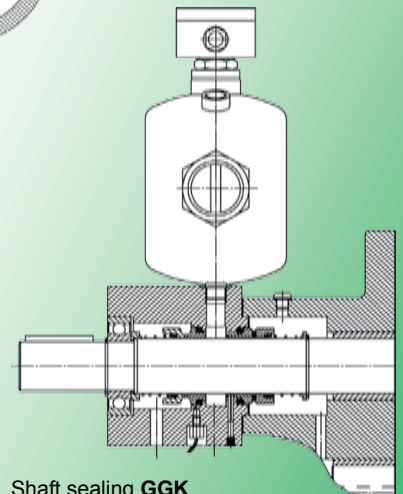

Shaft sealing GGK  
with quench vessel

## Examples of models

### For the food processing

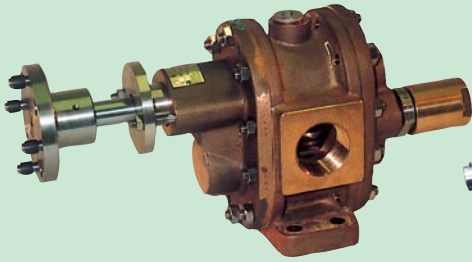

T in zinc-free bronze



T in stainless steel

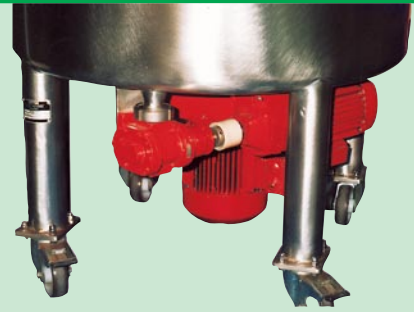

e.g. for leaven filling

### For the paint and printing ink industry

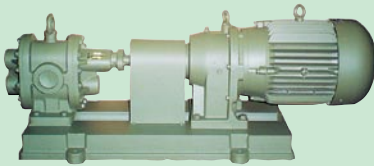

Pump aggregate T, standard design



Pump aggregate T, ATEX design with quench vessel

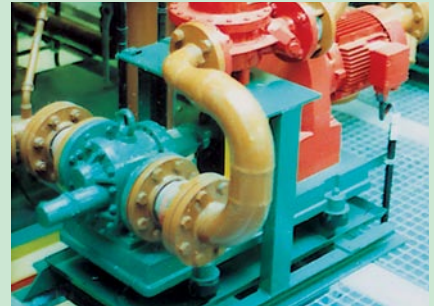

e.g. in printing-ink installation

### For the bitumen processing

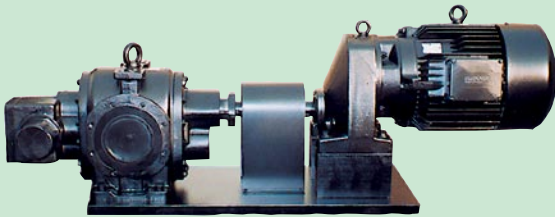

Pump unit with shell-heatable pump body and valve with baseplate, coupling and geared motor for asphalt-mixing installations



e.g. Pump station, complete with thermal-oil circulation pump and piping for asphalt-mixing installations

### For the chocolate production

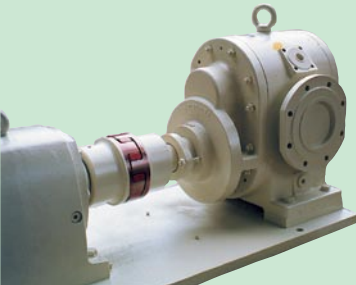

Gear pump TM (up to 1800 cm<sup>3</sup>/revolution) for chocolate and cocoa mass



e.g. as Stand-by-pump at an chocolate tank