



MARINE PRODUCT DATA SHEET
OEM: 357-014-00 (600 GPH)
AFTERMARKET: 357-014-10 (600 GPH)

Everything you are looking for in an aerator pump. Our tough, high density nylon housing and heavy duty water cooled motor give the SHURflo Aerator Pumps unparalleled reliability. Patented anti-airlock feature allows the pump to clear trapped air in rough water or when the boat is anchored. All Piranha Series Aerator Pumps have a removable cartridge for easy cleaning.

TYPICAL APPLICATIONS

12V DC Bait/Livewell Application. For other applications, contact SHURflo.

PUMP

Type: Centrifugal Pump
 Output Port: 3/4" Barb
 Intake Port: 3/4" NPS-M
 Liquid: 130 °F [54 °C] Max
 Prime: Flooded Inlet
 Inlet PSI: 30 PSI [2.1 Bar] Max
 Run Dry: No

ELECTRICAL

Motor: 12VDC Permanent Magnet, Continuous Duty
 Protection: External Fuse
 Leads: 6 ft (1.8M) Tinned, 16 AWG
 Fuse: 4 Amp Recommended
 Control: No Control

MATERIALS

Housing: High Strength Nylon
 Impeller: High Strength Nylon
 Hardware: Stainless Steel

APPROVALS

Ignition Protected, CE, ISO 8846

WARRANTY

2 Year Limited Warranty
 See SB-1050 For Full Warranty Details

SHIPPING

Net Weight (Boxed): 1.5 Lb (0.68 Kg) each
 Carton Weight: 27 Lb [12.2 Kg]
 Pumps in Carton: 18
 Carton Size: 24"L x 18"W x 11" H [61 cm x 46 cm x 28 cm]

RELATED DOCUMENTS

Catalog: MS-030-140
 Installation Manual: 911-611-00
 Maintenance: 911-611-00
 Applications Spec Guide: MS-020-005
 Warranty: SB-1050

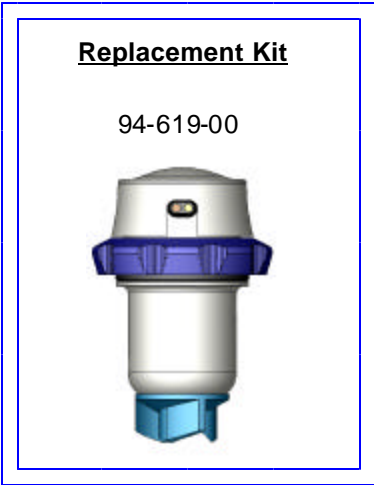

PERFORMANCE @ 13.6V DC

PRESSURE		FLOW		CURRENT
METERS	FT OF HEAD	GPH	LPH	AMPS
0.0	0	620	2346	1.4
1.2	4	210	794	1.5
2.4	8	0.0	0.0	1.3

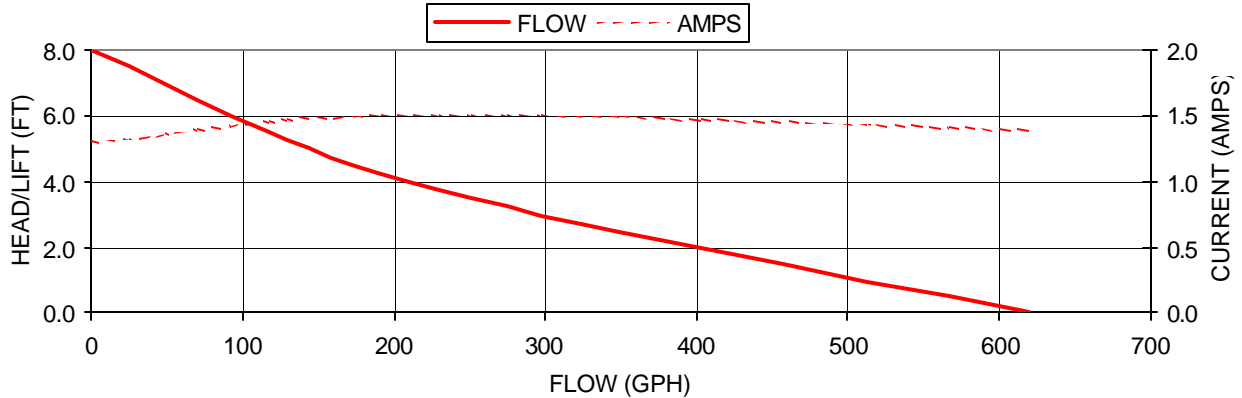

DIMENSIONS [mm]

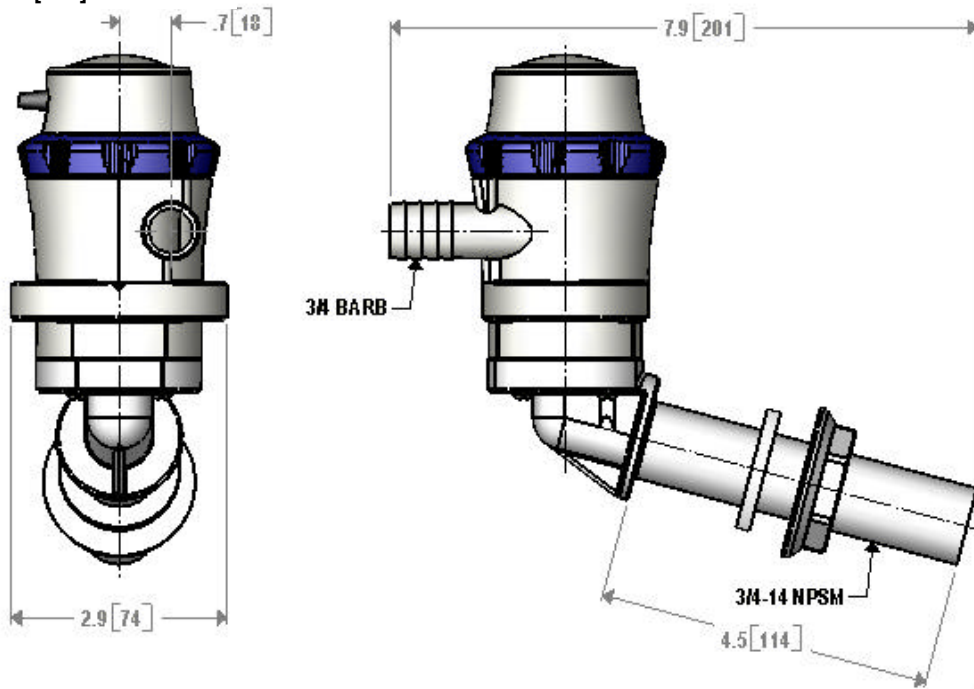

*ISO Registered Facility

SHURflo reserves the right to update specifications, prices, or make substitutions.



SHURflo *
5900A Katella Ave.
Cypress, Ca. 90630
(800) 854-3218 (562) 795-5200
FAX (562) 795-7554
Shipping/UPS: 5900C Katella Ave.
Cypress, Ca. 90630

SHURflo East
52748 Park Six Court
Elkhart, IN 46514-5427
(800) 762-809 (574) 262-0478
FAX (574) 264-2169
Http://www.shurflo.com
© 2001

SHURflo Ltd. *
Unit 5 Sterling Park
Gatwick Road, Crawley
West Sussex, RH10 2QT
United Kingdom
+44 1293 424000
FAX +44 1293 421880