

CHEMSTEEL®

CHEMSTEEL SERIES 930 METALLIC



A full range of accessories are available including:

- close coupled mounting kits
- baseplate/pedestal mounting kits
- line mounted pressure relief valves

GENERAL DESCRIPTION

Chemsteel pumps are designed to handle common and highly corrosive liquids that must be pumped under pressure. Manufactured to extremely precise tolerance, the Chemsteel pump line prevents system contamination while maintaining the purity and integrity of the liquid being pumped. Its rugged, three-section, o-ring sealed thru-bolt construction provides ease of servicing and parts replacement. Helical gearing offers noise reduction by as much as 10db, while the tandem pumps double the output flow for a single fluid, or with isolation, handle other fluids in direct ratio to the first. Additionally, Chemsteel pumps offer bi-directional operation for applications requiring reversing flow.

LIFE CYCLE/COST OF OWNERSHIP

Pump design and materials selection, together provide the longest life available from a gear pump.

Key attributes include:

- Gear & bearing combinations of metallic and nonmetallic wear surfaces.
- Slotted bearings to lubricate shaft and gear surfaces.
- Hydraulic porting to balance axial thrust and to reduce wear.
- Ample port sizing to reduce the likelihood of cavitation when inlet pressure is marginal.
- Effective housing seals with elastic memory prevent leakage of corrosives.

PERFORMANCE

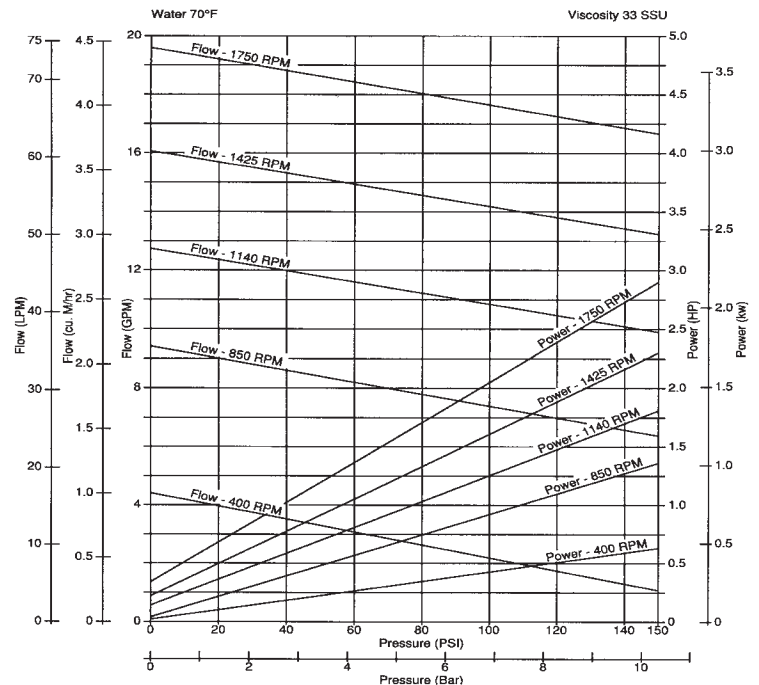

Notes: For continuous service:

- Plastic / Plastic gear combinations are limited to 50 psi.
- Metal / Plastic gear combinations are limited to 100 psi.
- Metal/Metal gear combinations are limited to 150 psi.
- Horsepower requirements increase for viscous fluids.

SPECIFIC SOLUTIONS

Gear/bearing design allows for "trimming" for optimizing the pump's maximum flow to reach minimum turndown or to match flow to a specific OEM's requirement.

Special materials combinations are available for specific liquids:

- Stainless or Alloy C housing construction.
- Gears available in 316 stainless, W88 stainless and Alloy C. Also in Teflon®, Ryton® and PEEK®.
- Shafts are 316 stainless steel or Alloy C.
- Bearings available in carbon or Teflon®.

Full range of seal options including lip seal, packing and mechanical designs.

FIT

Connections are 1 1/2" female NPT or BSPT, pump hardware is metric and close couple adapters mount to both NEMA and IEC standard motor frame sizes for world wide acceptance. "Near" dimensional interchangeability offers easy upgrade to Chemsteel pump. The port size is the same as competitive pumps.

MAINTENANCE

A three-part housing provides easy disassembly and service. Full size bearings match the gear diameter, and eliminate the need for separate wear plates. TFE encapsulating silicone o-ring pump housing seals provide elastic memory to assure an effective long lasting seal and thus avoiding the re-torquing required of pumps using pure TFE. The upper shaft configuration lends itself to in-line pump seal maintenance without the leakage of trapped chemicals from an incompletely drained pump.

To order a CHEMkit®, simply add a "K" to the end of the model number. A repair kit contains the following parts: seals, bearings, gears, o-rings, shafts, keys, c clips, and retaining ring.

MODEL	S930
maximum flow (gpm) @ 1750 rpm	20
theoretical displacement (cc/revolution)	50.1
maximum differential pressure (psig)	150
maximum system pressure (psig)	225
maximum speed (RPM)	1800
maximum fluid temperature	450° F
minimum fluid temperature	-50° F
standard port size	1 1/2 inch FNPT
weight (lbs)	10

CLOSE-COUPLED DIMENSION

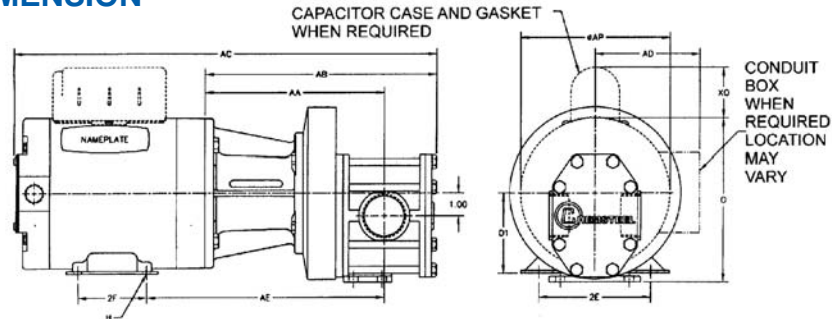

adapter code	kit part no.	motor frame		D1	2E	2F	H	O	AP	XO	AA	AB	AC	AD	AE			
C1	M9AD56	56C	INCHES	3.50	4.88	3.00	ø.34 SLOT	6.88	6.63	2.25	7.88	10.18	18.56	-	10.44			
			MILLIMETERS	88.9	124	76.2	ø8.6 SLOT	174.8	168.4	57.2	200.2	258.6	471.5	-	265.2			
C2	M9AD45T	143TC	145TC	INCHES	3.50	5.90	4.00	5.00	ø.34 SLOT	6.88	6.63	2.25	200.2	258.6	19.75	21.25	-	10.26
		MILLIMETERS	88.9	139.7	102	127	ø8.6 SLOT	174.8	168.4	57.2	7.88	10.18	501.7	539.8	-	260.6		
		182C	184C	INCHES	4.50	7.50	4.50	5.50	ø.41 SLOT	8.69	7.88	2.38	200.2	258.6	22.47	21.69	-	10.76
		MILLIMETERS	114.3	190.5	114.3	139.7	ø10.41 SLOT	220.7	200	60.3	200.2	258.6	570.7	550.9	-	273.3		
C4	M9AD80E	IEC 80, B14 FACE	INCHES	3.15	4.92	3.94	ø.39 SLOT	6.00	5.69	-	7.38	9.68	19.22	4.51	9.35			
			MILLIMETERS	80	125	100	ø10 SLOT	152.4	144.5	-	187.5	245.9	488.2	116	237.5			
C5	M9AD90E	IEC 90, B14 FACE	INCHES	3.54	5.51	3.94	ø.39 SLOT	6.81	6.61	-	7.88	10.18	20.88	5.12	9.90			
			MILLIMETERS	90	140	100	ø10 SLOT	173	168	-	200.2	258.6	532.9	130	251.5			
C6	M9AD84T	182TC	184TC	INCHES	4.50	7.50	4.50	5.50	ø.41	8.69	7.88	2.38	200.2	258.6	23.28	22.5	-	10.83
		MILLIMETERS	114.3	190.5	114.3	139.7	ø.41	220.7	200	60.3	8.69	10.99	591.3	571.5	-	270		
		213C	215C	INCHES	5.25	8.50	5.50	7.00	ø10.4	10.25	9.58	2.75	220.8	279.2	23.5	25.12	-	11.38
		MILLIMETERS	133.4	215.9	139.7	177.8	ø10.4	260.4	242.8	69.9	220.8	279.2	596.9	638	-	289.1		
C7	M9AD100E	IEC100, B14 FACE	INCHES	3.94	6.30	4.41	ø.47 SLOT	7.91	7.88	-	8.07	10.37	23.35	5.88	10.19			
			MILLIMETERS	100	160	112	ø12 SLOT	180	200	-	205	263.4	593.1	149.2	258.8			

1 These dimensions vary depending on hp, enclosure, speed and motor manufacturer. Specifications are subject to change without notification.

PEDESTAL MOUNT DIMENSIONS

	A	B	C			D	E	F	G	H	K			L	M	N	O	P	R
			Mechanical	Pack ²	Lip						Diameter	Standard drive	Lower drive						
inches	1.50	0.625	1.65	1.65	1.65	7.81	5.50	4.16	1.25	2.13	0.41	3.88	1.88	4.00	5.53	0.25	3.00	4.00	2.88
millimeters	15.9	41.9	41.9	41.9	41.9	198.4	139.7	105.7	31.8	54.1	10.4	98.4	47.6	101.6	140.5	6.4	76.2	101.6	73.2

2. Dimension is approximated with packing nut installed

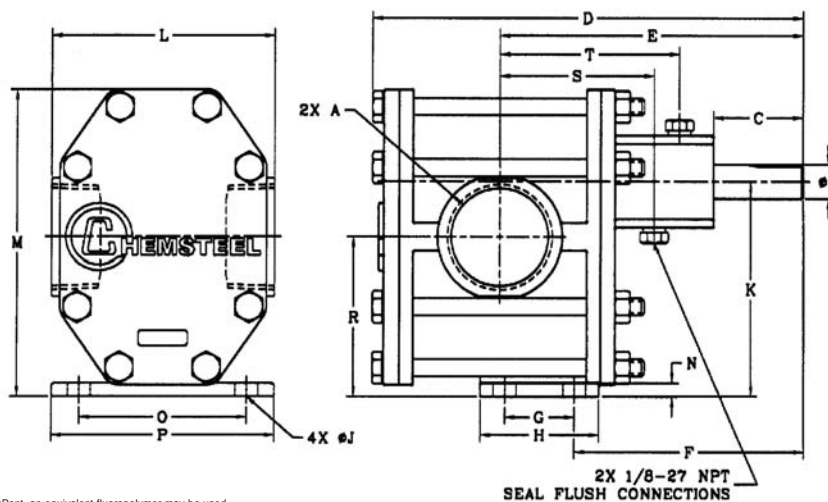

Teflon® is a registered trademark of DuPont, an equivalent fluoropolymer may be used.
 Ryton® is a registered trademark of Chevron Phillips Chemical, an equivalent polyphenylenesulfide may be used.
 PEEK® is a trademark of Victrex, an equivalent polyetheretherketone may be used.

* Standard Upper Drive Shown