

# OBERDORFER

## BRONZE

### ROTARY GEAR PUMPS

**SERIES**  
**1000 4000**  
**2000 7000**  
**3000 9000**

## General Instructions and Parts Lists

### CARBON BEARINGS

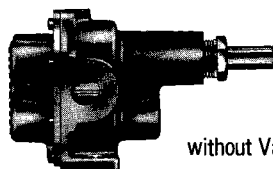

without Valve

MODELS  
 1000 4000  
 2000 7000  
 3000 9000

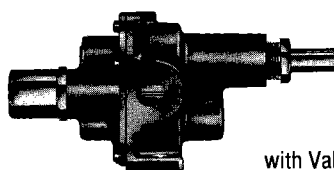

with Valve

MODELS  
 1000R 4000R  
 2000R 7000R  
 3000R 9000R

### BRONZE BEARINGS

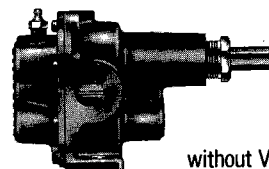

without Valve

MODELS  
 1000B 4000B  
 2000B 7000B  
 3000B 9000B

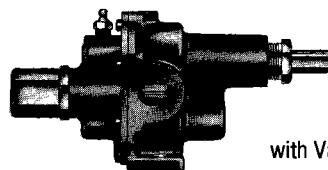

with Valve

MODELS  
 1000BR 4000BR  
 2000BR 7000BR  
 3000BR 9000BR

### GENERAL DESCRIPTION

Pump housing and gears are made of top quality bronze, shafts are from stainless steel 303. Pumps are available with bronze bearings and grease fittings or with carbon bearings which require no lubrication.

Gear pumps are positive displacement pumps. Each shaft revolution displaces a definite amount of liquid relatively unaffected by the back pressure in the discharge line. Shaft speed and flow are directly proportional. Recommended pressure limits are 100 psi for water and non-lubricants, 150 psi for oil and lubricants. The maximum shaft speed is 1750 rpm.

### MOUNTING AND DRIVE ARRANGEMENT

Pumps should be mounted on a rigid base in line with the electric motor. Direct drive with a flexible shaft coupling is the preferred method. Extreme care must be taken to align the pump shaft with the motor shaft within .005 inch. When a V-belt drive is chosen a separate ball bearing pedestal (pillow block) must be added to the pump in order to absorb the belt tension.

### LIQUIDS AND TEMPERATURE

These pumps are suitable for all liquids that are compatible with bronze. The most common liquids are water, oil and mild chemicals in the PH-range of 4 to 10. Gear pumps are particularly suitable for viscous liquids up to 100,000 SSU viscosity at reduced shaft speeds as low as 200 rpm.

Because of their close internal clearances gear pumps are definitely not recommended for liquids containing solids, abrasives, powders or paint pigments. If abrasives are unavoidable and the resulting short pump life is acceptable, pump should be driven at slow shaft speed and bronze bearings should be chosen.

Best liquid temperature range is from 32°F to 140°F. More extreme temperatures are possible from -40°F to 400°F. However, factory should be consulted for choices of shaft seal, bearing selection and other points of caution. Freezing of water-filled pumps can cause damage and must be avoided.

### SUCTION LIFT

As a general rule the suction lift should be kept at an absolute minimum by placing the pump as close to the liquid source as possible. A gear pump in new condition can lift 20 feet of water in the suction line. A foot valve (preferably with built-in strainer) is recommended at the beginning of the suction line. For a first start-up the pump should be primed to avoid dry running. Minimum size of the suction pipe is the size of the pump inlet port. For longer suction lines (over 3 feet) or for viscous liquids the pipe size should be at least one size or two sizes larger than the pump inlet port. A reducing pipe coupling must be used at the pump entrance port.

### RELIEF VALVE

If the discharge line contains any throttling devices such as a shut-off valve, a spray nozzle or other restrictive device it is necessary to have a relief valve in the system which returns the liquid to the suction side or to the tank. The relief valve is also available as part of the pump itself (R-model pumps). However, built-in relief valves are only good for intermittent service. If used continuously, pump will overheat. A built-in relief valve is strictly a safety device against overpressure. It will not work successfully as a pressure or flow control device. For this purpose a separate relief valve in the pressure line must be used.

# PERFORMANCE TABLE

SPEED R.P.M.	PUMP SIZE	0 P.S.I.		50 P.S.I.		100 P.S.I.		150 P.S.I.	
		G.P.M.	H.P.	G.P.M.	H.P.	G.P.M.	H.P.	G.P.M.	H.P.
400	1000	.50	.01	.05	.02	----	----	----	----
	2000	.97	.02	.25	.09	----	----	----	----
	3000	1.50	.05	.55	.14	----	----	----	----
	4000	2.30	.10	1.65	.23	1.10	.40	.65	.70
	7000	4.00	.20	2.62	.35	1.30	.65	1.00	.90
800	1000	1.03	.02	.64	.08	.24	.15	----	----
	2000	2.03	.04	1.52	.13	1.00	.29	.30	.45
	3000	3.17	.08	2.51	.27	1.85	.48	1.30	.65
	4000	4.65	.20	4.00	.37	3.50	.86	3.05	1.60
	7000	8.58	.30	7.58	.72	6.57	1.15	6.20	1.70
1200	1000	1.50	.03	1.12	.13	.75	.21	.45	.29
	2000	2.92	.05	2.41	.19	1.90	.36	1.00	.58
	3000	4.85	.15	4.23	.39	3.58	.68	3.20	1.00
	4000	7.10	.25	6.50	.50	5.90	.97	5.45	1.70
	7000	13.3	.50	12.4	.97	11.4	1.65	11.1	2.20
1725	1000	2.10	.05	1.80	.17	1.50	.28	1.20	.39
	2000	4.07	.10	3.55	.25	3.03	.43	2.50	.68
	3000	7.25	.38	6.63	.73	6.00	1.10	5.50	1.40
	4000	10.6	.50	9.97	1.05	9.42	1.75	9.00	2.32
	7000	19.8	.80	18.9	1.63	18.0	2.65	17.4	3.60
9000	23.3	.90	22.3	1.73	21.3	2.70	20.1	3.70	

Above performance table applies to liquids at 33 SSU viscosity. Liquids of higher viscosities require lower shaft speeds and higher horsepower (details on page 4).

## DIMENSIONS *See letter A for pipe size* (Inlet and outlet same)

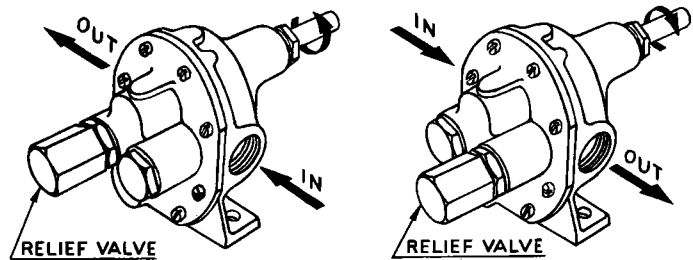
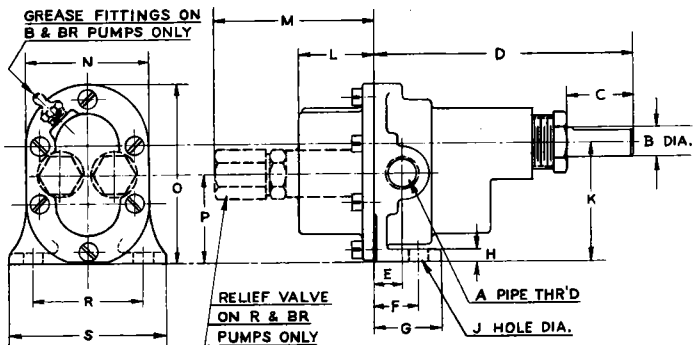

## ROTATION AND RELIEF VALVE

The drawing shows the relationship between shaft rotation, direction of flow and location of relief valve (R-models only). If valve happens to be on wrong side for a chosen rotation, it can easily be relocated. Standard pressure setting for valve is 50 psi. Increase pressure by turning adjusting screw (item 14, page 3) in clockwise direction.

	A	B	C	C*	C**	D	E	F	G	H	J	K	L	M	N	O	P	R	S
1000	1/4	.500	1.00	1.69	1.03	4.44	.44	.69	1.06	.19	.32	1.88	1.19	2.81	1.94	2.88	1.41	1.75	2.50
2000	1/4	.500	1.00	1.69	1.03	4.44	.47	.75	1.19	.25	.34	2.36	1.25	2.69	2.38	3.56	1.70	2.25	3.00
3000	3/8	.625	1.19	1.88	1.13	5.13	.53	.75	1.25	.25	.41	2.63	1.44	3.13	2.75	4.00	1.88	2.88	3.75
4000	1/2	.625	1.13	1.81	1.13	5.44	.69	.88	1.44	.25	.41	2.63	1.44	3.13	2.75	4.00	1.88	2.88	3.75
7000	3/4	.625	1.31	2.00	1.25	5.63	.75	.88	1.44	.31	.41	3.56	1.44	3.38	3.75	5.25	2.56	3.25	4.25
9000	1"	.625	1.31	2.00	1.25	5.88	.88	.88	1.69	.31	.41	3.56	1.44	3.38	3.75	5.25	2.56	3.25	4.25

C - for Packing    C\* - for Lip Seal    C\*\* - for Mechanical Seal

## EXPLODED VIEW AND PARTS LIST

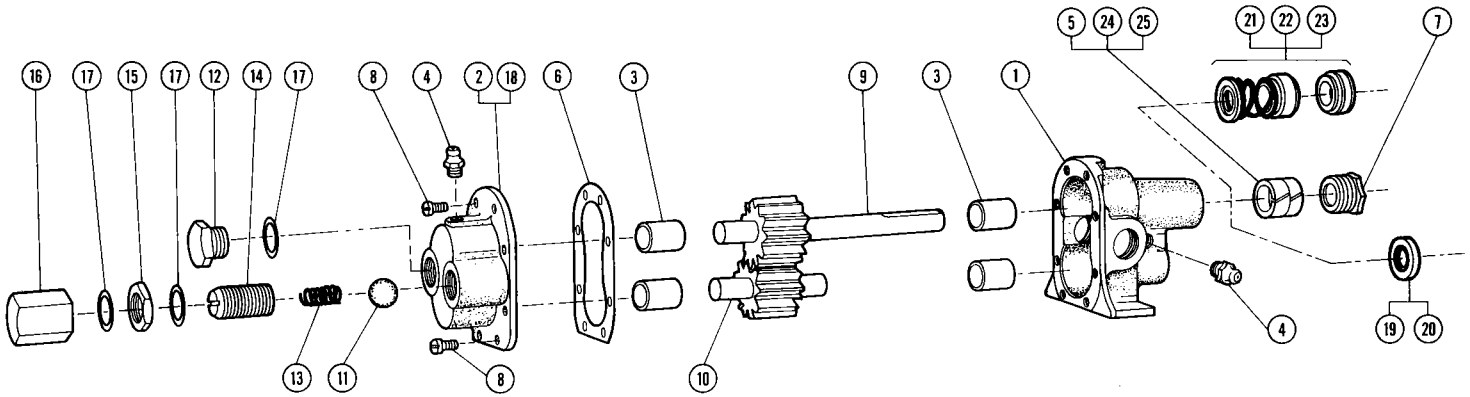

PARTS LIST		Req.	1000 1000R	1000B 1000BR	2000 2000R	2000B 2000BR	3000 3000R	3000B 3000BR	4000 4000R	4000B 4000BR	7000 7000R	7000B 7000BR	9000 9000R	9000B 9000BR
1	Body	1	5170	5804	5171	5833	5172	5877	5173	5878	5174	5879	5175	5880
2*	Cover (see *Note)	1	5779	5778	5802	5801	5900	5807	5900	5807	5901	5810	5901	5810
3	Bearing, Carbon	4	5024	—	5024	—	5091	—	5091	—	5091(3) 5092(1)	—	5091(3) 5092(1)	—
4	Grease Fitting	2	—	5390	—	5390	—	5390	—	5390	—	5390	—	5390
5	Packing Ring	2	5481	5481	5481	5481	5479	5479	5479	5479	5479	5479	5479	5479
6	Gasket	1	5226	5226	5258	5258	5227	5227	5227	5227	5247	5247	5247	5247
7	Packnut	1	1892	1892	1892	1892	1762	1762	1762	1762	1762	1762	1762	1762
8	Screw	8	5385	5385	5385	5385	5385	5385	5385	5385	5385	5385	5385	5385
9	Drive Gear Assembly	1	32101	32101	32102	32102	32103	32103	32104	32104	32105	32105	32106	32106
10	Idle Gear Assembly	1	32110	32110	32111	32111	32112	32112	32113	32113	32114	32114	32115	32115
	Repair Kit contains items 3, 5, 6, 9, 10	1	10635	—	10641	—	10636	—	10637	—	10638	—	10639	—
	Repair Kit contains items 5, 6, 9, 10	1	—	10645	—	10646	—	10647	—	10648	—	10649	—	10650
in addition to the above parts, R-model pumps contain the following valve parts listed below														
11	Ball	1	5809	5809	5238	5238	5206	5206	5206	5206	6217	6217	6217	6217
12	Plug Nut	1	5775	5775	1838	1838	5205	5205	5205	5205	5278	5278	5278	5278
13	Spring	1	5806	5806	1840	1840	5207	5207	5207	5207	5277	5277	5277	5277
14	Adjusting Screw	1	5766	5766	5237	5237	5200	5200	5200	5200	5275	5275	5275	5275
15	Locknut	1	5774	5774	5240	5240	5209	5209	5209	5209	1642	1642	1642	1642
16	Valve Nut	1	5767	5767	5239	5239	5204	5204	5204	5204	5276	5276	5276	5276
17	Fiber Washer	3	6966	6966	6533	6533	6964	6964	6964	6964	6965	6965	6965	6965
18*	R-Cover (see *Note)	1	5777	5765	5839	5808	5902	5811	5902	5811	5903	5812	5903	5812

\*Note: On R-model pumps item 18 (R-Cover) replaces item 2 (Cover).

SEAL OPTIONS		1000 ...		2000 ...		3000 ...		4000 ...		7000 ...		9000 ...	
		1000R ...	1000B ...	2000R ...	2000B ...	3000R ...	3000B ...	4000R ...	4000B ...	7000R ...	7000B ...	9000R ...	9000B ...
No.	Part Name	add applicable S-Suffix to Pump Number											
19	Lip Seal, Buna	S3	5007	5007	5463	5463	5463	5463	5463	5463	5463	5463	5463
20	Lip Seal, Viton	S5	7580	7580	6916	6916	6916	6916	6916	6916	6916	6916	6916
21	Mechan. Seal, Buna	S6	32201	32201	32202	32202	32202	32202	32202	32202	32202	32202	32202
22	Mechan. Seal, Viton	S7	32234	32234	32235	32235	32235	32235	32235	32235	32235	32235	32235
23	Mechan. Seal, Chemlon	S8	32209	32209	32193	32193	32193	32193	32193	32193	32193	32193	32193
24	Packing, Teflon	S1	7129	7129	7130	7130	7130	7130	7130	7130	7130	7130	7130
25	Packing Grafoil	S12	8308	8308	8309	8309	8309	8309	8309	8309	8309	8309	8309

See next page for explanation of Seal Options.

## SHAFT SEAL OPTIONS

### PACKING (STUFFING BOX)

Oberdorfer Bronze Gear Pumps are normally supplied with a packing type shaft seal, also known as stuffing box. No S-Suffix is to be used for the standard packing. This type of shaft seal is widely used because of its simplicity and ease of replacement. However, packings require a slight liquid drip-page (leak) to prevent overheating of packing.

While the standard graphite-fabric packing is satisfactory for most applications, there are two up-graded packings available: Teflon packing (S 1) and Grafoil packing (S 12). All packings are interchangeable.

### LIP SEAL

Lip Seals are positive, zero-leakage shaft seals. Often referred to as oil seals, the rubber lip directly contacts the shaft surface. When worn out, lip seals are replaceable. The standard lip seal (S 3) has Buna rubber elements for temperatures to 250°F. The more expensive S 5 lip seal has Viton rubber elements for solvent resistance and for temperatures to 300°F.

Lip Seals are not interchangeable with packings or mechanical seals. However field conversion kits are available to convert a packing type pump to lip seal. Consult factory for details.

### MECHANICAL SEAL

This type of zero-leakage seal has long service life and it is the most costly seal. It is available with Buna elements (S 6) and with Viton elements (S 7). When the application requires a Teflon mechanical seal, the Chemlon seal (S 8) must be specified.

Mechanical seals are not interchangeable with packings or lip seals.

## PUMP MAINTENANCE AND REPAIR

Oberdorfer gear pumps are essentially maintenance-free except for the bronze bearing series (B-models) which require periodic lubrication of the grease fittings. Special precautions must be taken when glue-like materials are being pumped. To prevent binding of the gears, it is necessary to flush pump with an appropriate solvent after each use.

If the pump is to be shut down for an extended period of time it should be flushed thoroughly and filled with a trace of light lubricating oil to facilitate start-up. If freezing conditions are expected the pump must be drained to prevent bearing push-out and casting warpage.

As a general rule it is seldom economical to repair a worn-out gear pump. However, if the gear chamber inside the pump body is still in good condition, the replacement of all interior parts by use of a repair kit may restore up to 80% of the original pump performance. Repair kit numbers and parts contained in each kit are listed on the previous page.

Oberdorfer does not routinely repair or re-condition used gear pumps.

### WARRANTY

Oberdorfer gear pumps are covered by a limited warranty against defective workmanship and materials for a period of 6 months from date of purchase.

For the purpose of a warranty claim the pump must be returned prepaid to the factory for a warranty inspection with prior notification and approval of such return.

Short service life of a pump caused by pumping of abrasive materials or pump damage caused by aggressive chemicals, mis-aligned motor shafts, excessive pressure or other installation-related problems do not constitute a warranty claim.

## PUMPING OF VISCOUS LIQUIDS WITH GEAR PUMPS

Gear pumps are well suited for pumping viscous liquids if the following rules are observed.

- (1) Pump speed (RPM) must be reduced. Use Table No. 1 below as a guide.
- (2) Suction and discharge lines must be increased by at least one, or better two pipe sizes over the size of the pump ports.

TABLE NO. 1  
SPEED REDUCTION

Viscosity in SSU	Recommended Speed (RPM)
50	1725
500	1500
1,000	1300
5,000	1000
10,000	600
50,000	400
100,000	200

- (3) Horsepower must be increased over the amount of horsepower required for pumping water (33 SSU). Use Table No. 2 below to multiply the water horsepower (page 2) to arrive at the viscous horsepower.

Example: No. 4000 pump, 1200 RPM, 50 PSI, 1000 SSU  
water horsepower from page 2 is 0.5 HP  
viscous horsepower:  $0.5 \times 1.4 = 0.7$  HP  
use a 3/4 HP motor.

TABLE NO. 2  
MULTIPLIERS FOR HORSEPOWER

Pressure PSI	Viscosity in SSU					
	500	1000	5000	10,000	50,000	100,000
2	1.30	1.60	2.20	3.00	4.00	5.00
20	1.25	1.50	2.00	2.60	3.60	4.50
40	1.20	1.40	1.80	2.20	3.20	4.00
60	1.15	1.30	1.60	2.05	2.80	3.50
80	1.12	1.25	1.50	1.90	2.50	3.00
100	1.10	1.20	1.40	1.80	2.20	2.50

### VISCOSITY CONVERSION TABLE

SSU	Stokes	Centistokes	Poises	Centipoises	Engler Sec.	Liquid 70°F
33	.01	1	.008	.8	54	Water
500	1.10	110	.88	88	760	SAE 10 Oil
1,000	2.16	216	1.73	173	1,500	SAE 20 Oil
10,000	21.6	2,160	17	1,760	15,000	SAE 60 Oil
50,000	108	10,800	88	8,800	75,000	Molasses B
100,000	216	21,600	173	17,300	150,000	Molasses C

\*Poises and centipoises are given for oil of .8 spec. Gravity. Relationship: centistokes  $\times$  specific gravity = centipoises.