

Performance Curves

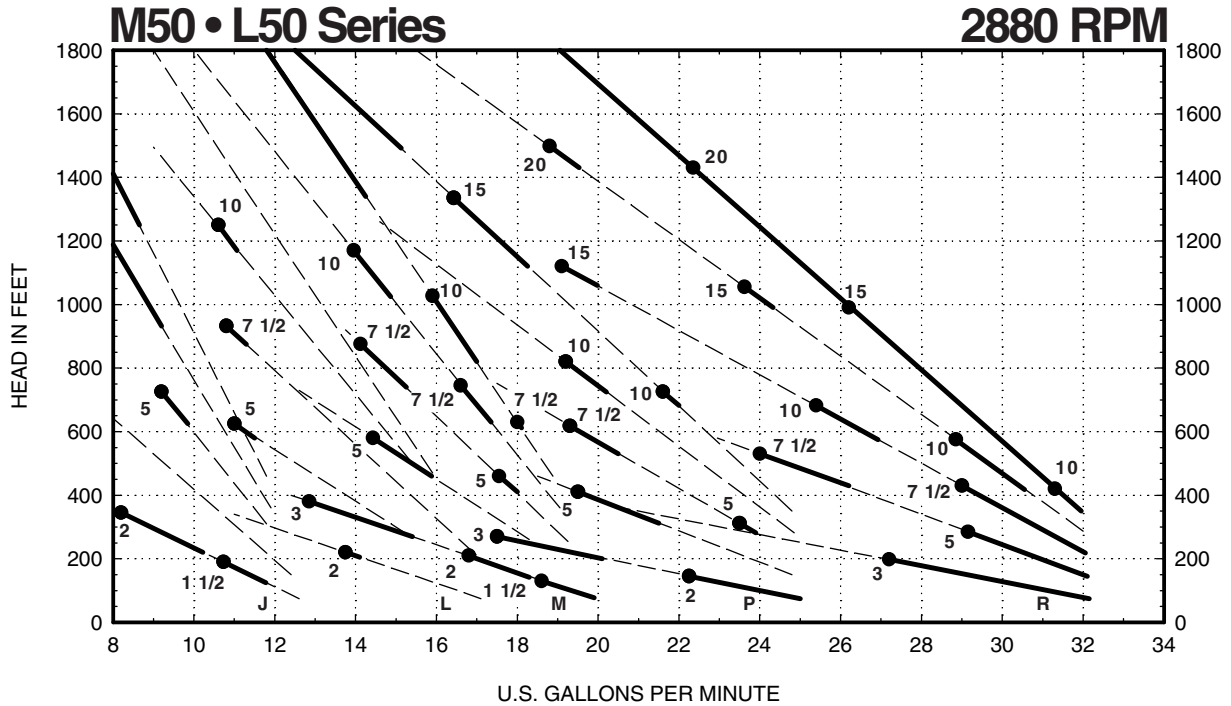

NOTES

- Indicates Motor Horsepower Rating for Standard MTH Motors
- Recommended Operating Range
- - - Acceptable Operating Range
- Horsepower data is valid for 1.0 specific gravity fluids only

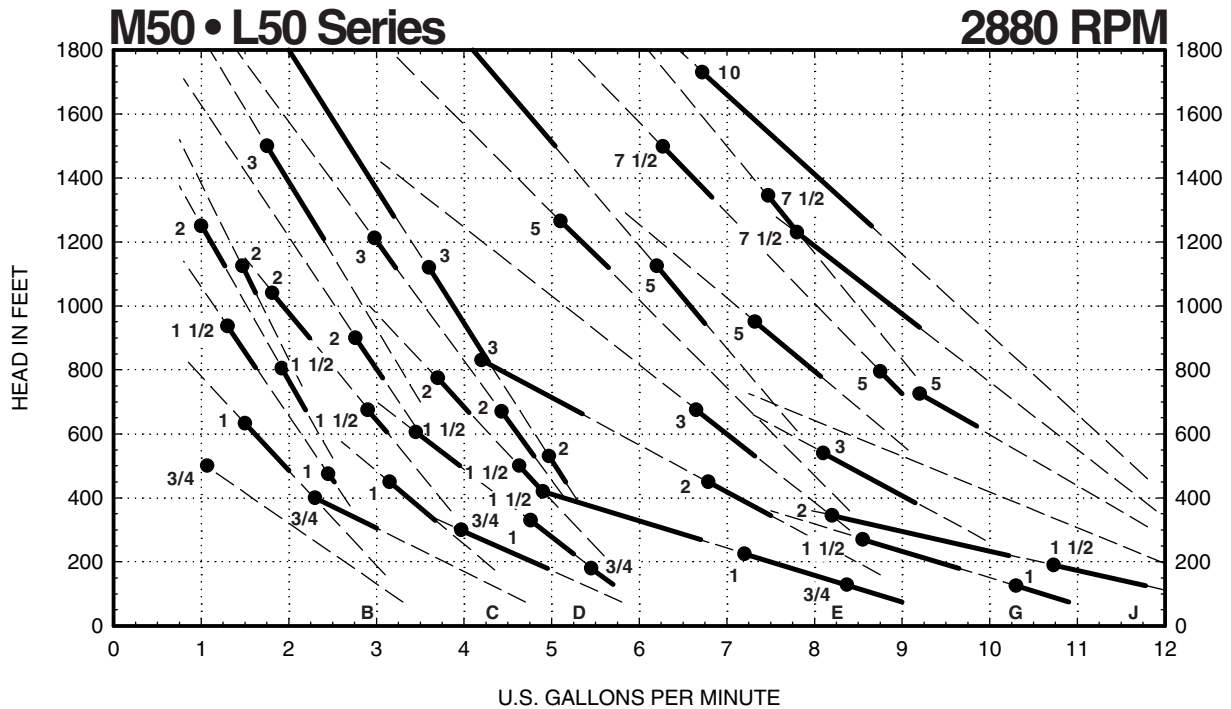

401 West Main Street • Plano, IL 60545-1436
Phone: 630-552-4115 • Fax: 630-552-3688

M50 • L50 SERIES

Performance Curves

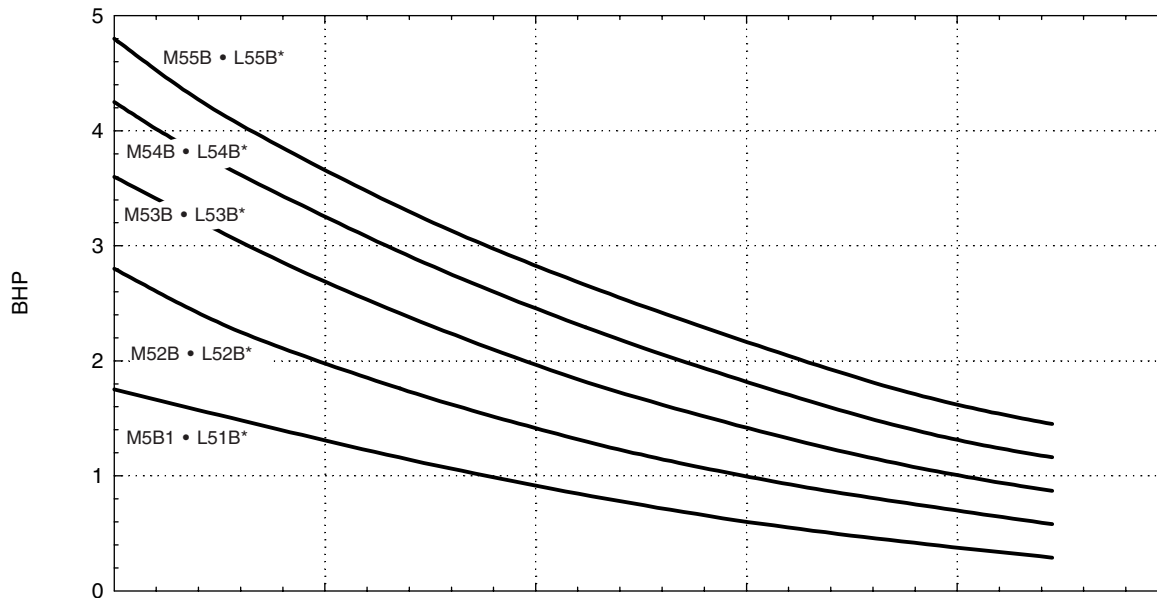
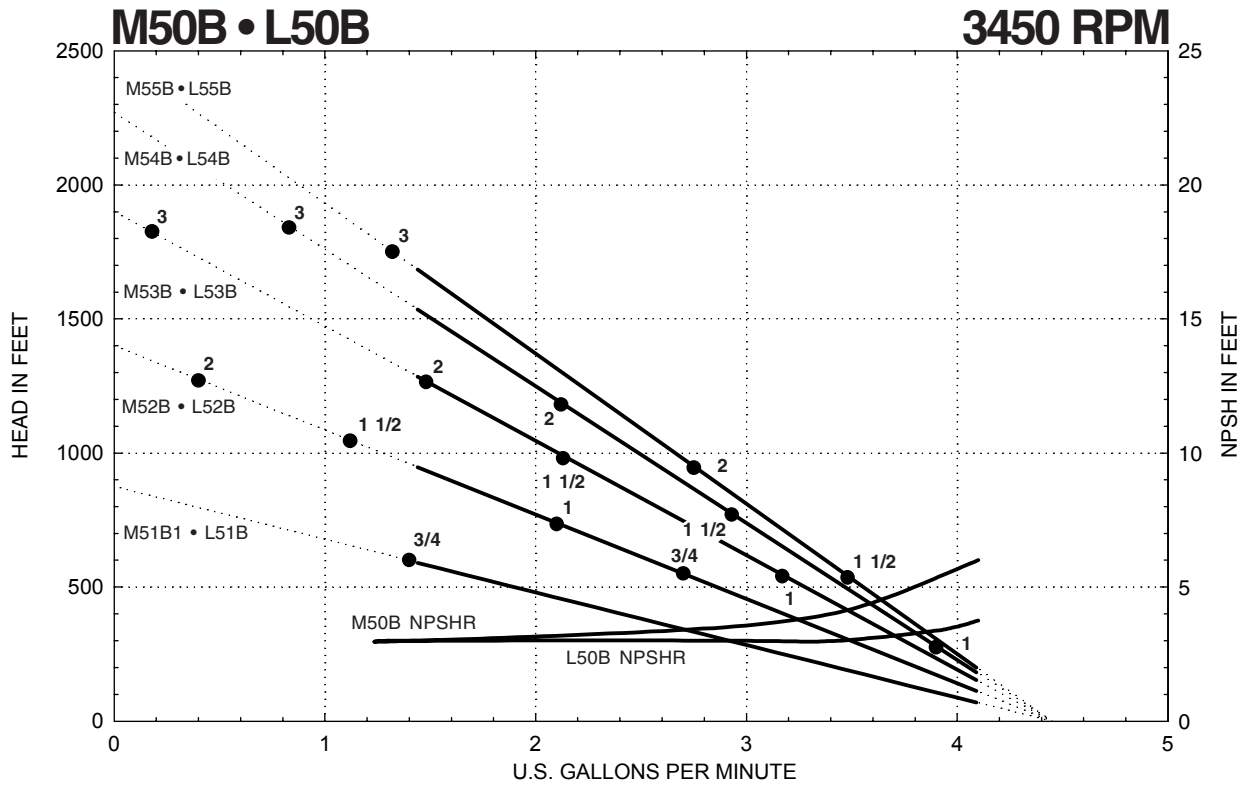

NOTES

- Indicates Motor Horsepower Rating
Using the Service Factor for Standard MTH Motors
- Recommended Operating Range
- · · · · Acceptable Operating Range
- *Add .43 horsepower for L50B Inducer Models
- Horsepower data is valid for 1.0 specific gravity fluids only



MTH PUMPS

401 West Main Street • Plano, IL 60545-1436
Phone: 630-552-4115 • Fax: 630-552-3688

Performance Curves

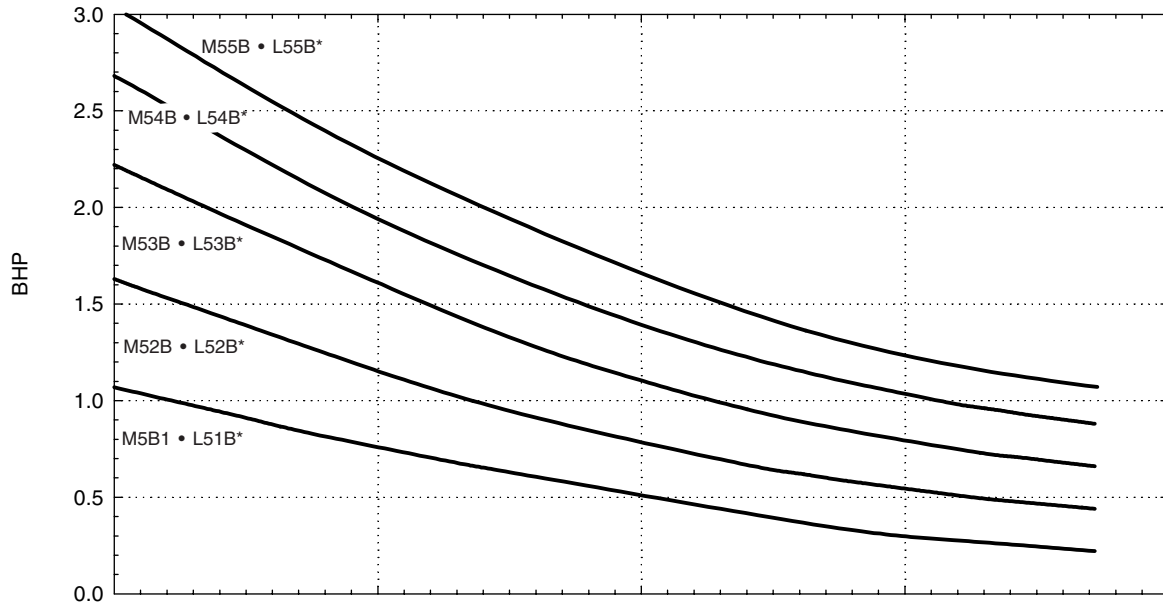
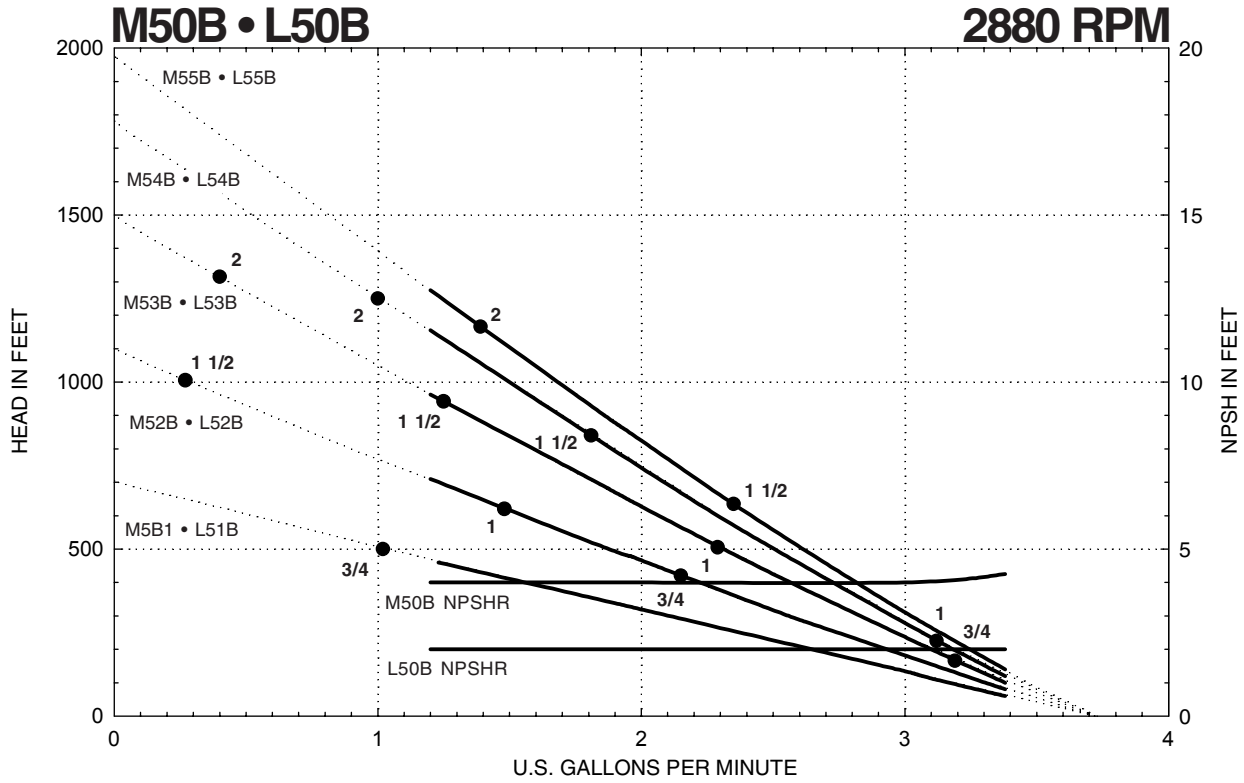

NOTES

● Indicates Motor Horsepower Rating for Standard MTH Motors

— Usable Operating Range

⋯ Refer to Factory for Operation in this Range

*Add .26 horsepower for L50B Inducer Models

Horsepower data is valid for 1.0 specific gravity fluids only



MTH PUMPS

401 West Main Street • Plano, IL 60545-1436
Phone: 630-552-4115 • Fax: 630-552-3688

M50 • L50 SERIES

Performance Curves

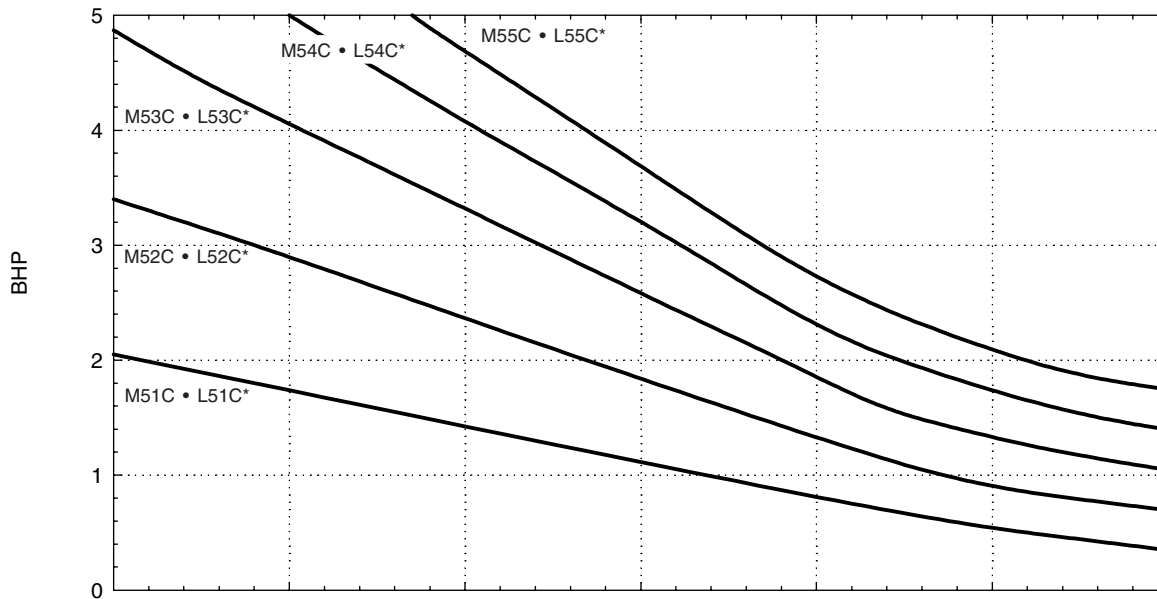
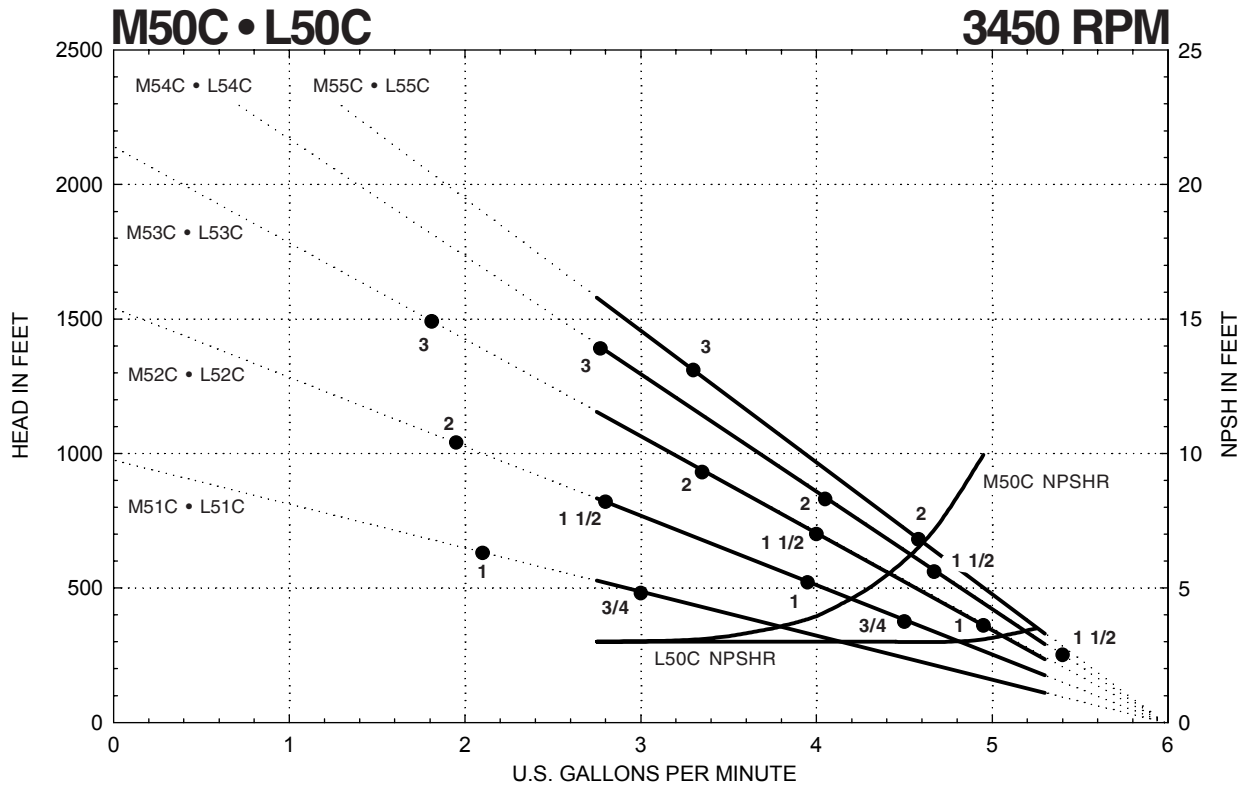

NOTES

- Indicates Motor Horsepower Rating
 Using the Service Factor for Standard MTH Motors
- Usable Operating Range
- · · · · Refer to Factory for Operation in this Range
- *Add .45 horsepower for L50C Inducer Models
- Horsepower data is valid for 1.0 specific gravity fluids only



MTH PUMPS

401 West Main Street • Plano, IL 60545-1436
 Phone: 630-552-4115 • Fax: 630-552-3688

Performance Curves

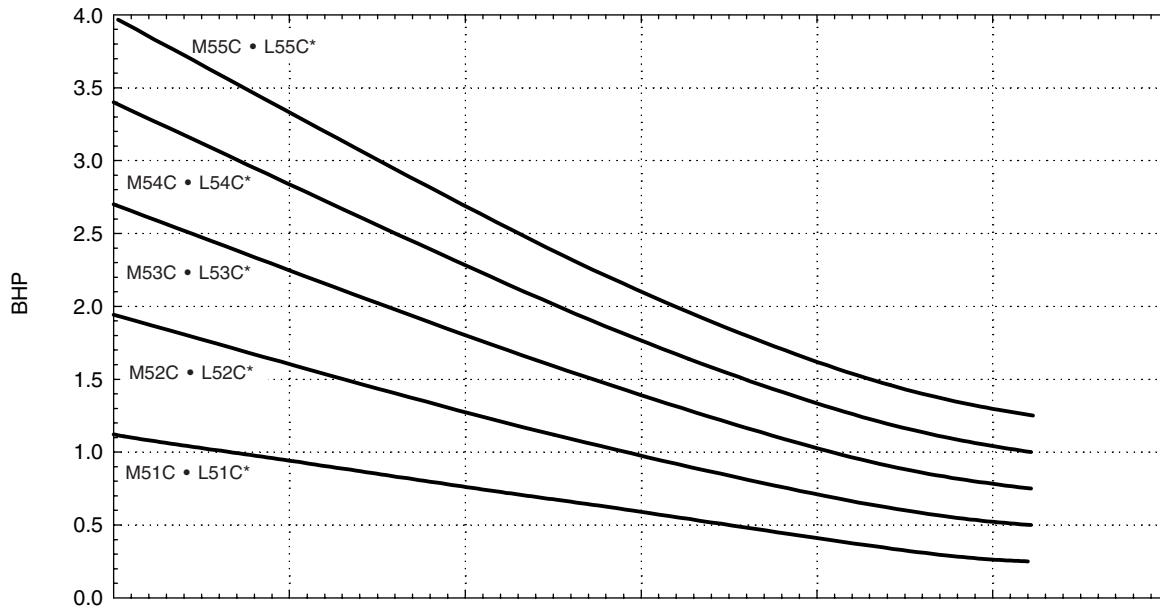
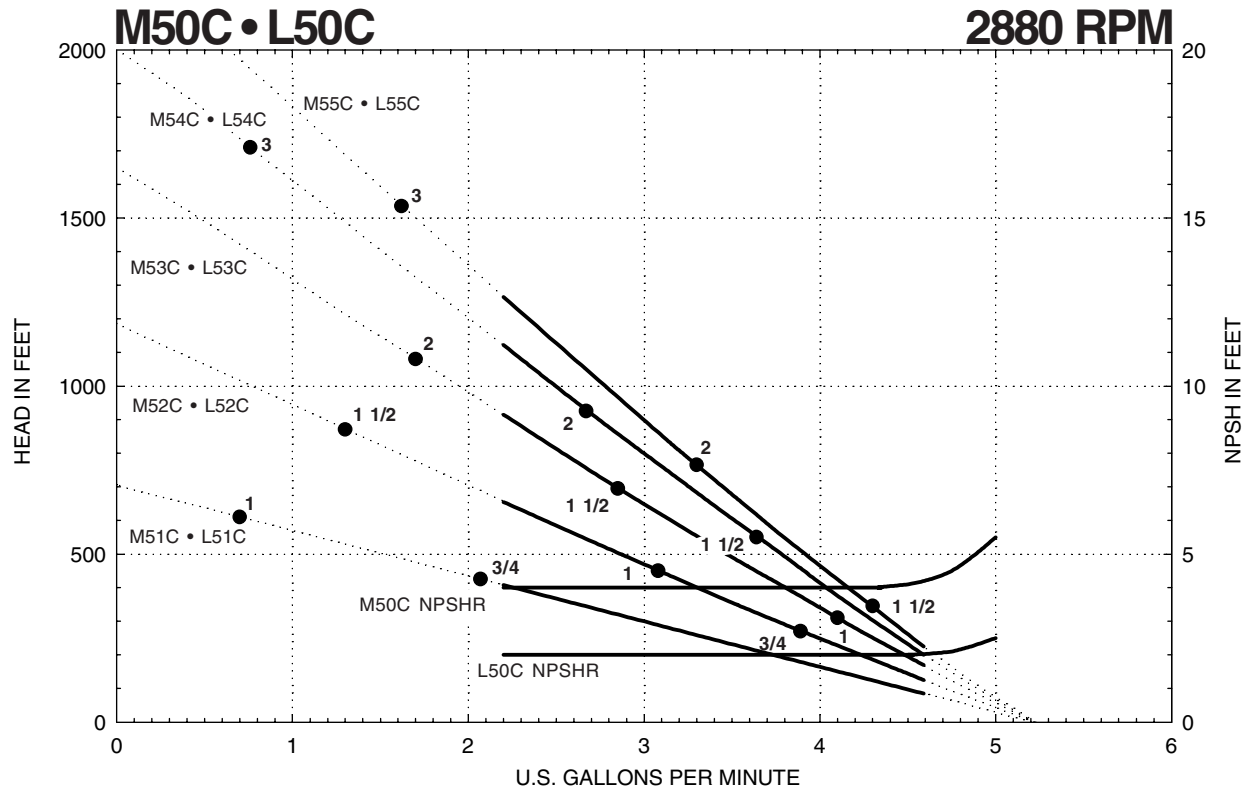

NOTES

- Indicates Motor Horsepower Rating for Standard MTH Motors
- Usable Operating Range
- ⋯ Refer to Factory for Operation in this Range

*Add .27 horsepower for L50C Inducer Models
Horsepower data is valid for 1.0 specific gravity fluids only



401 West Main Street • Plano, IL 60545-1436
Phone: 630-552-4115 • Fax: 630-552-3688

M50 • L50 SERIES

Performance Curves

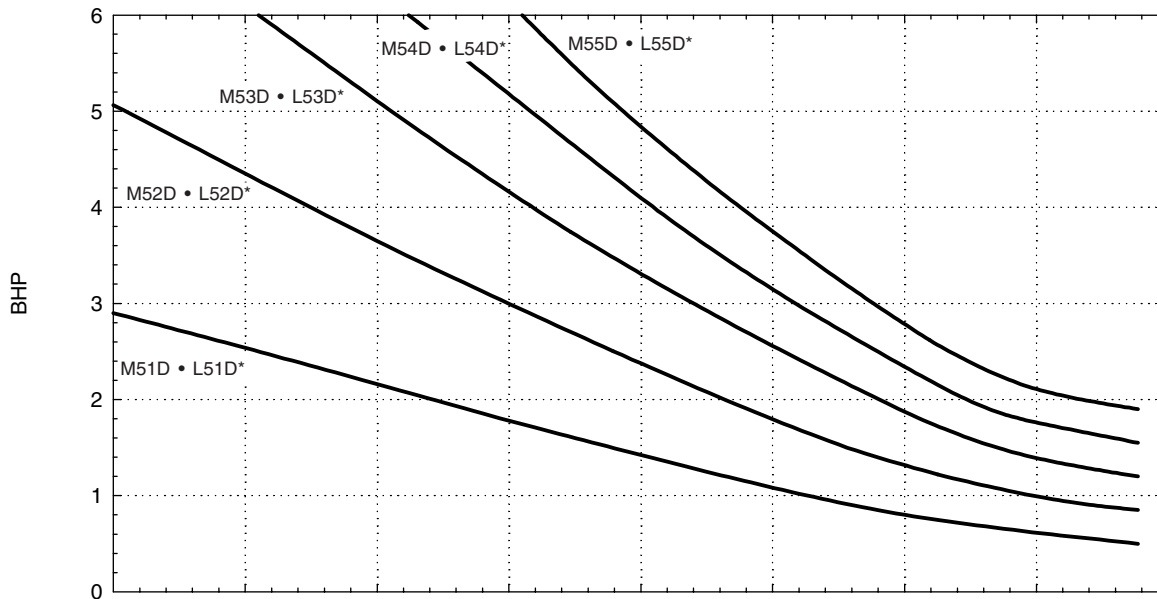
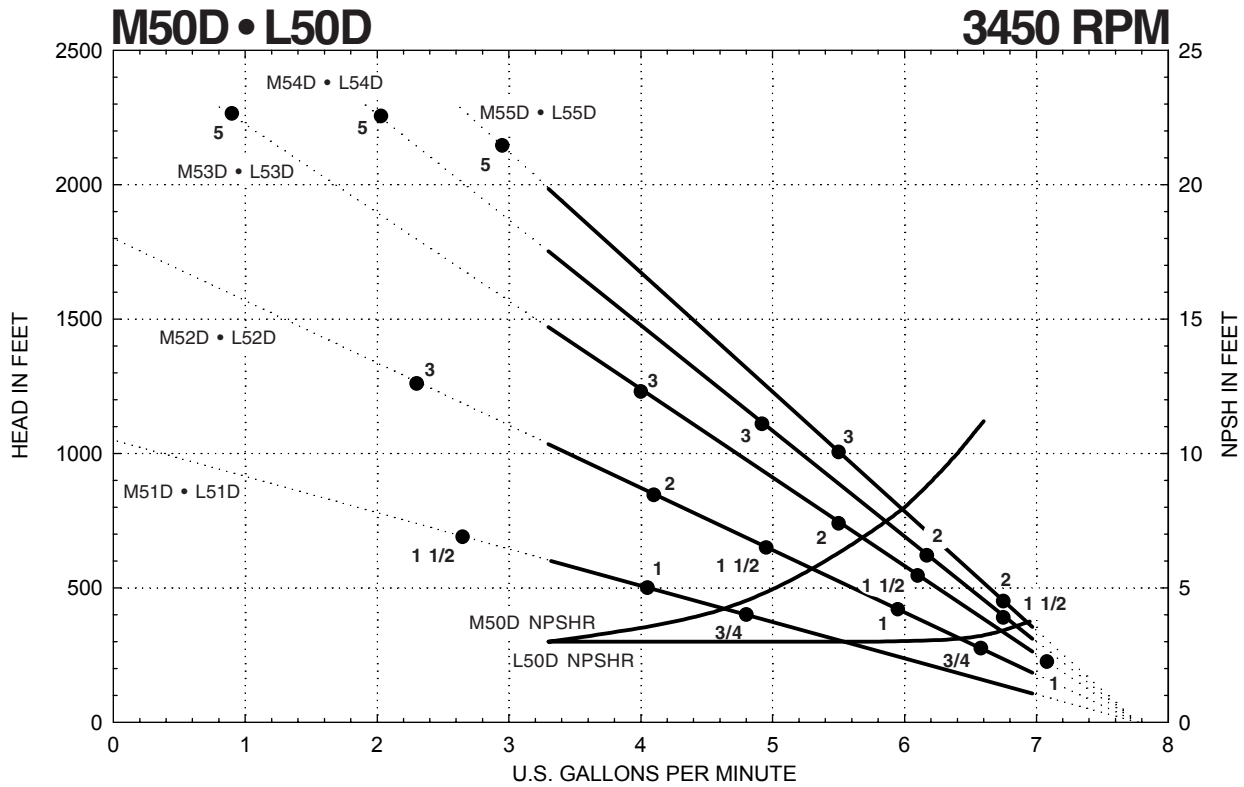

NOTES

- Indicates Motor Horsepower Rating
- Using the Service Factor for Standard MTH Motors
- Usable Operating Range
- ⋯ Refer to Factory for Operation in this Range
- *Add .49 horsepower for L50D Inducer Models
- Horsepower data is valid for 1.0 specific gravity fluids only



MTH PUMPS

401 West Main Street • Plano, IL 60545-1436
 Phone: 630-552-4115 • Fax: 630-552-3688

Performance Curves

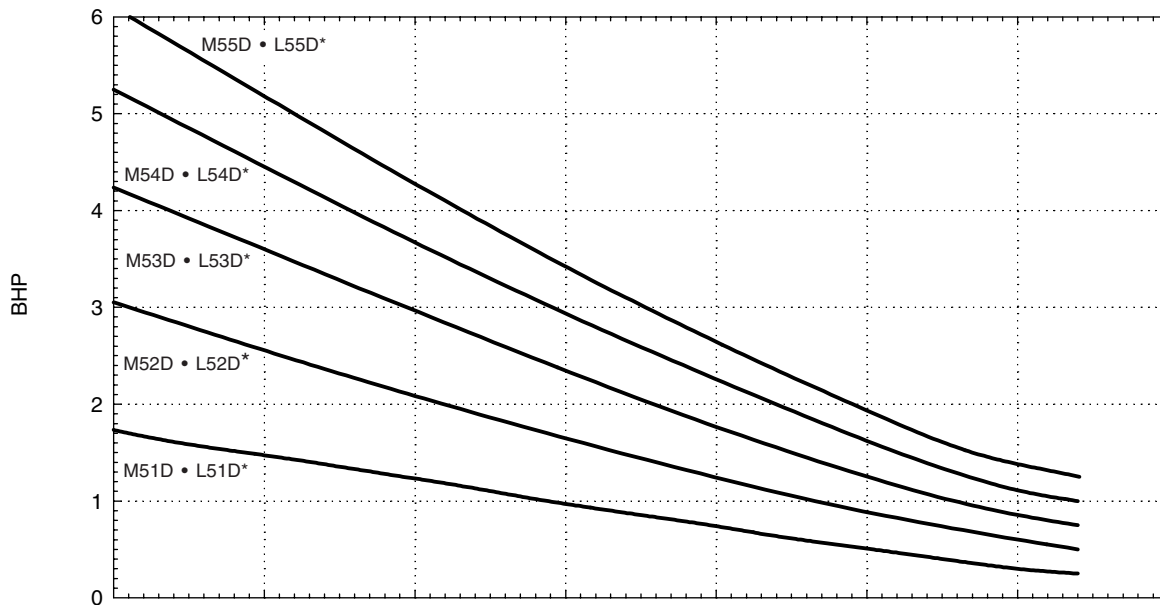
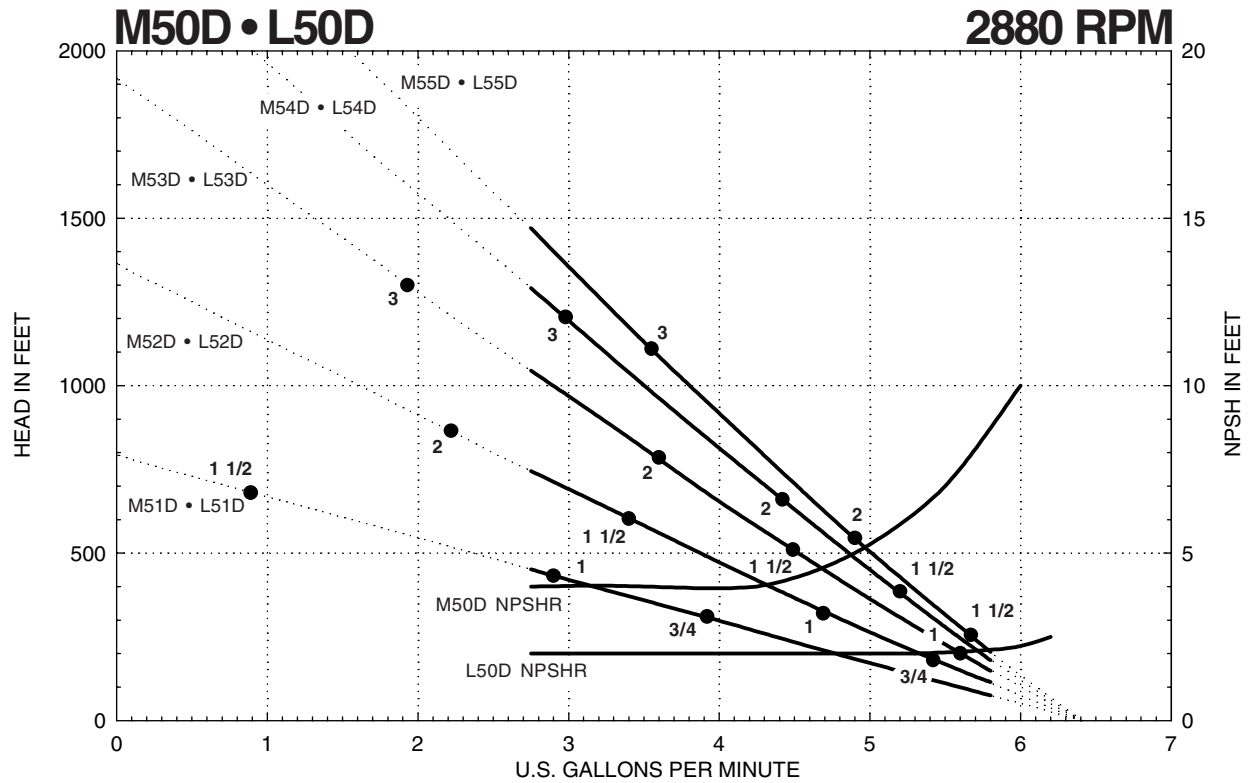

NOTES

- Indicates Motor Horsepower Rating for Standard MTH Motors
- Usable Operating Range
- · · · · Refer to Factory for Operation in this Range
- *Add .29 horsepower for L50D Inducer Models
- Horsepower data is valid for 1.0 specific gravity fluids only



401 West Main Street • Plano, IL 60545-1436
Phone: 630-552-4115 • Fax: 630-552-3688

M50 • L50 SERIES

Performance Curves

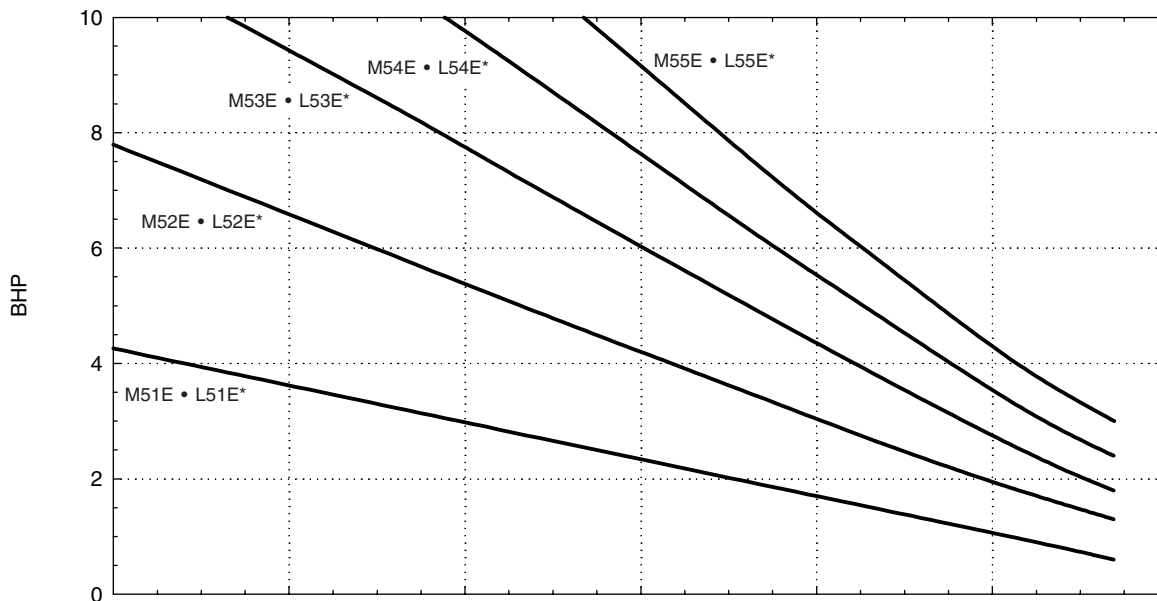
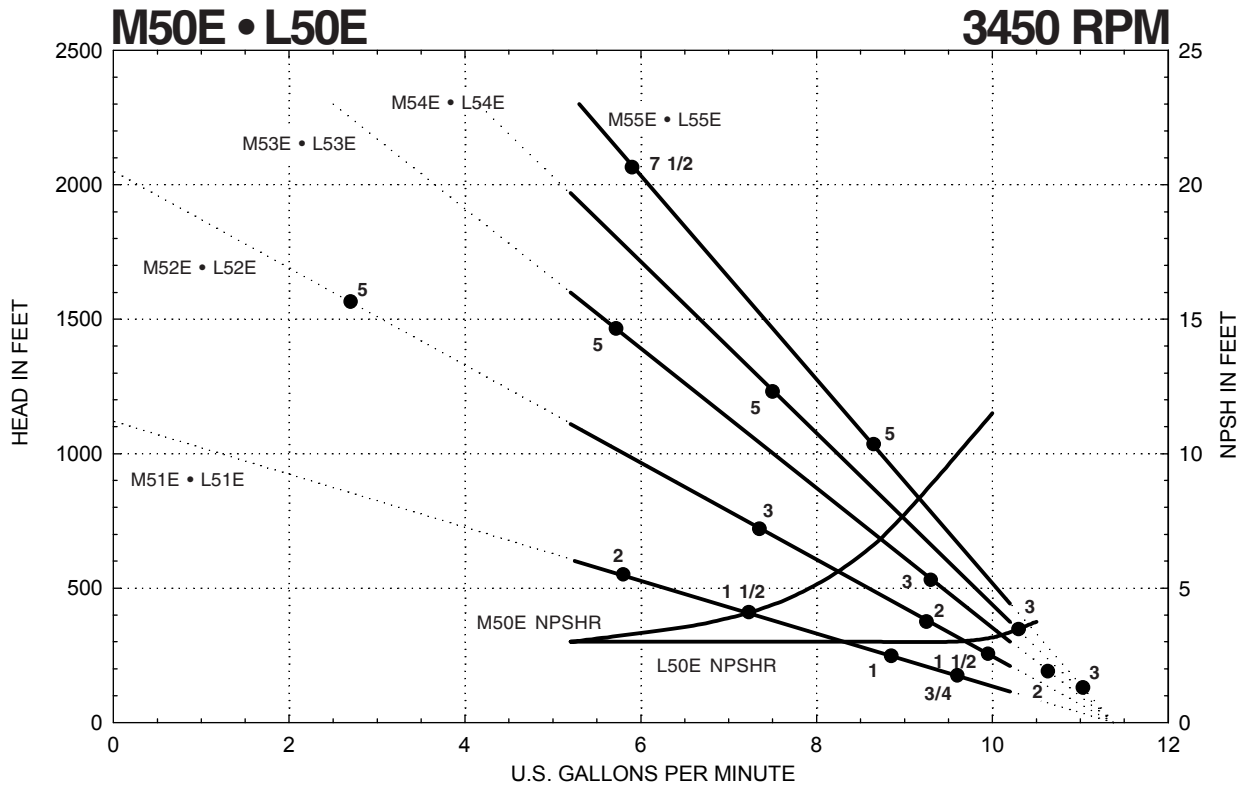

NOTES

- Indicates Motor Horsepower Rating
 Using the Service Factor for Standard MTH Motors
- Usable Operating Range
- ⋯ Refer to Factory for Operation in this Range
- *Add .57 horsepower for L50E Inducer Models
- Horsepower data is valid for 1.0 specific gravity fluids only



MTH PUMPS

401 West Main Street • Plano, IL 60545-1436
 Phone: 630-552-4115 • Fax: 630-552-3688

Performance Curves

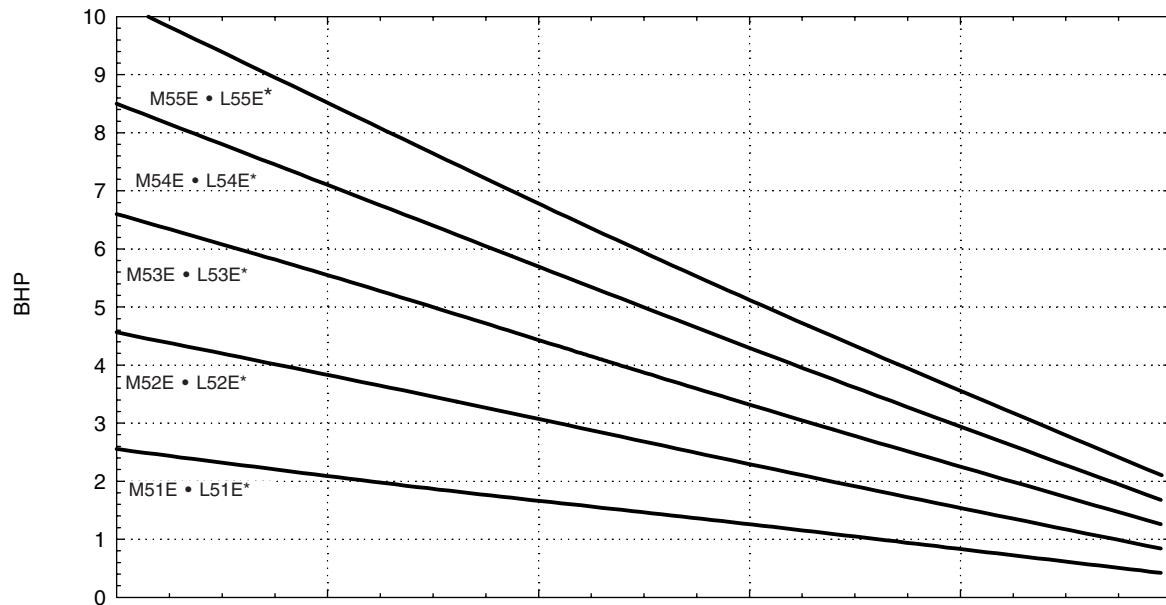
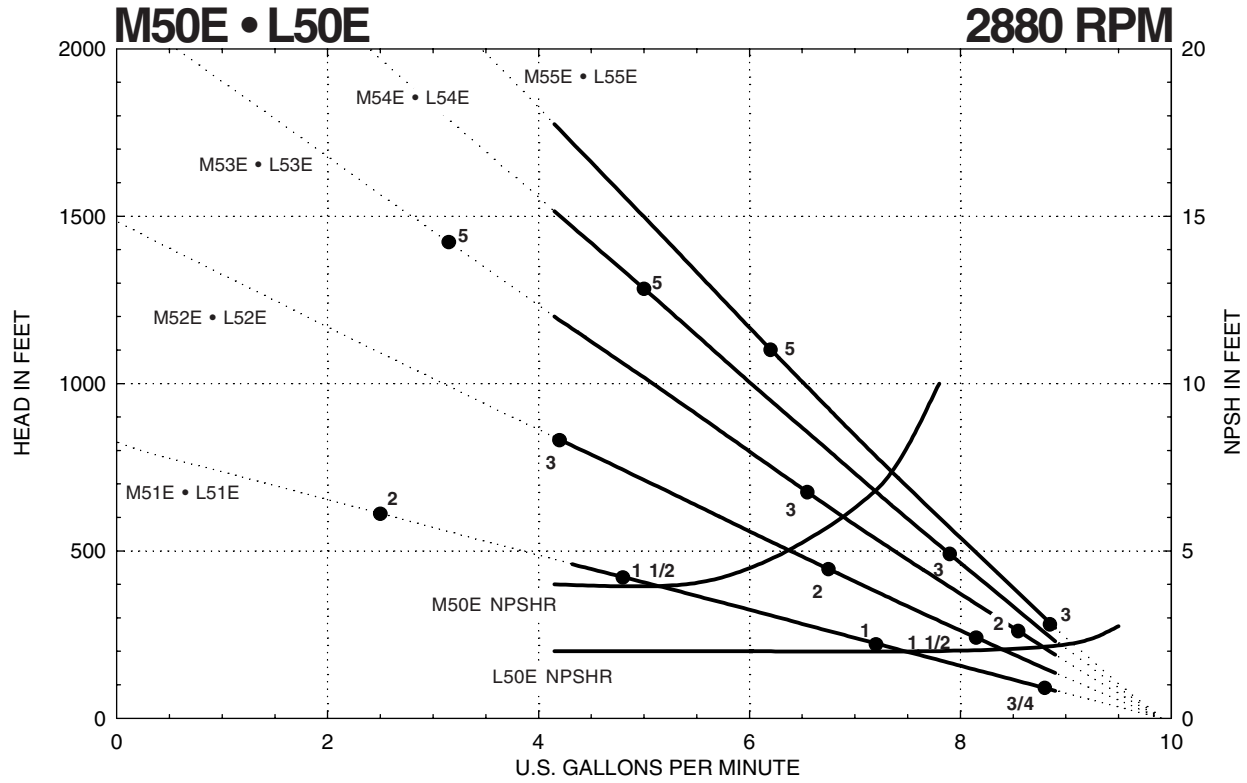

NOTES

- Indicates Motor Horsepower Rating for Standard MTH Motors
- Usable Operating Range
- ⋯ Refer to Factory for Operation in this Range
- *Add .33 horsepower for L50E Inducer Models
- Horsepower data is valid for 1.0 specific gravity fluids only



401 West Main Street • Plano, IL 60545-1436
Phone: 630-552-4115 • Fax: 630-552-3688

M50 • L50 SERIES

Performance Curves

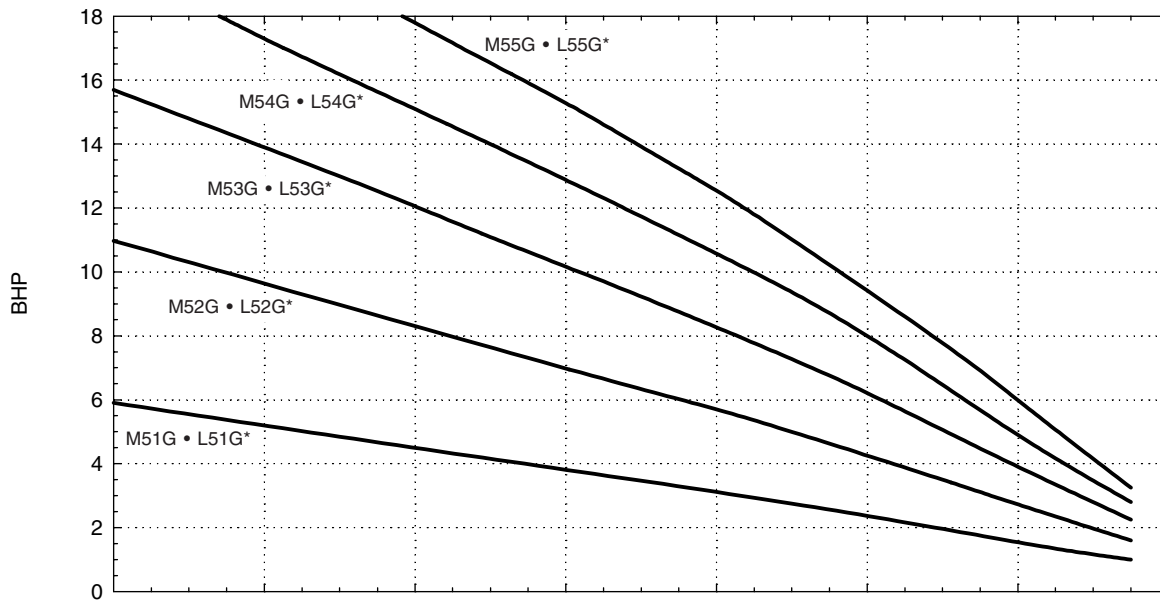
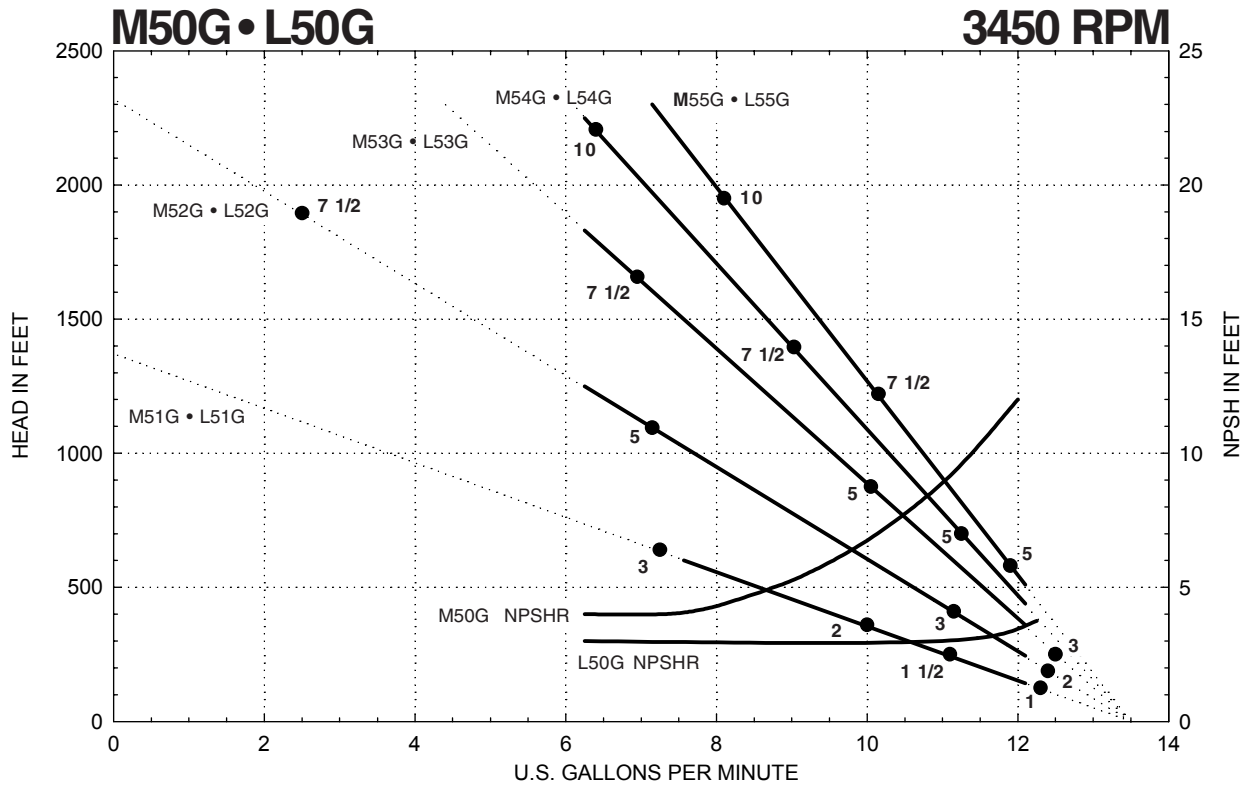

NOTES

- Indicates Motor Horsepower Rating
Using the Service Factor for Standard MTH Motors
- Usable Operating Range
- · · · · Refer to Factory for Operation in this Range
- *Add .62 horsepower for L50G Inducer Models
- Horsepower data is valid for 1.0 specific gravity fluids only



MTH PUMPS

401 West Main Street • Plano, IL 60545-1436
Phone: 630-552-4115 • Fax: 630-552-3688

Performance Curves

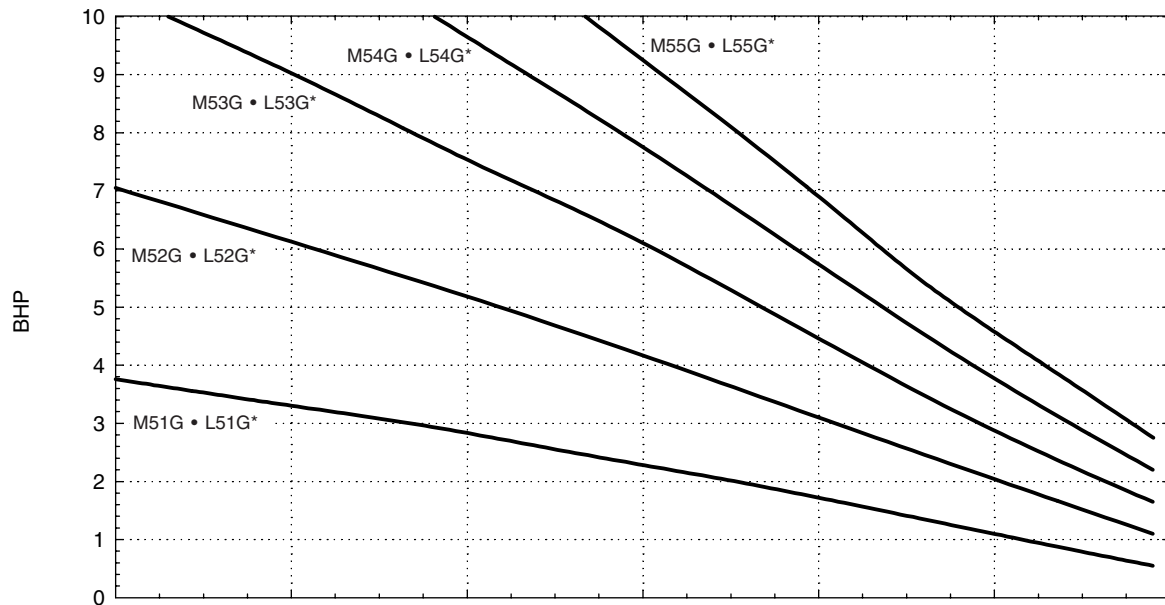
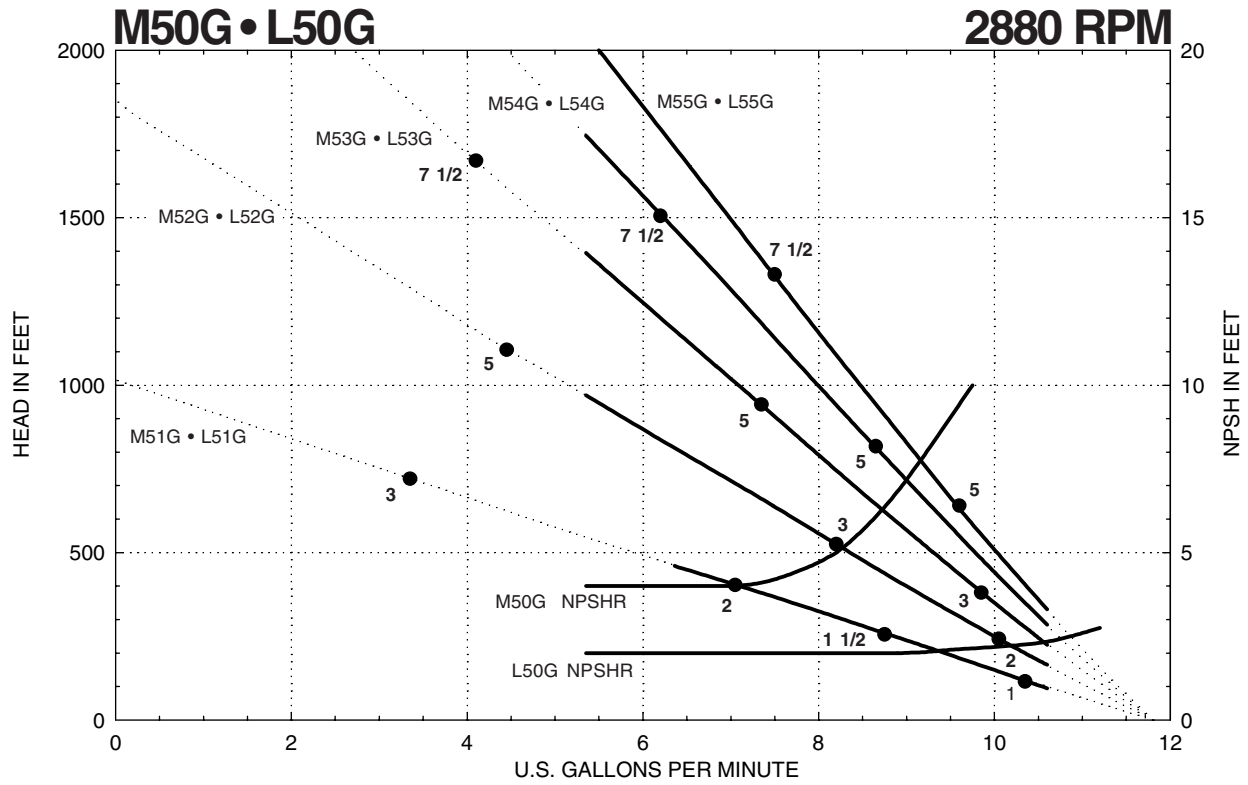

NOTES

- Indicates Motor Horsepower Rating for Standard MTH Motors
- Usable Operating Range
- ⋯ Refer to Factory for Operation in this Range
- *Add .35 horsepower for L50G Inducer Models
- Horsepower data is valid for 1.0 specific gravity fluids only



401 West Main Street • Plano, IL 60545-1436
Phone: 630-552-4115 • Fax: 630-552-3688

M50 • L50 SERIES

Performance Curves

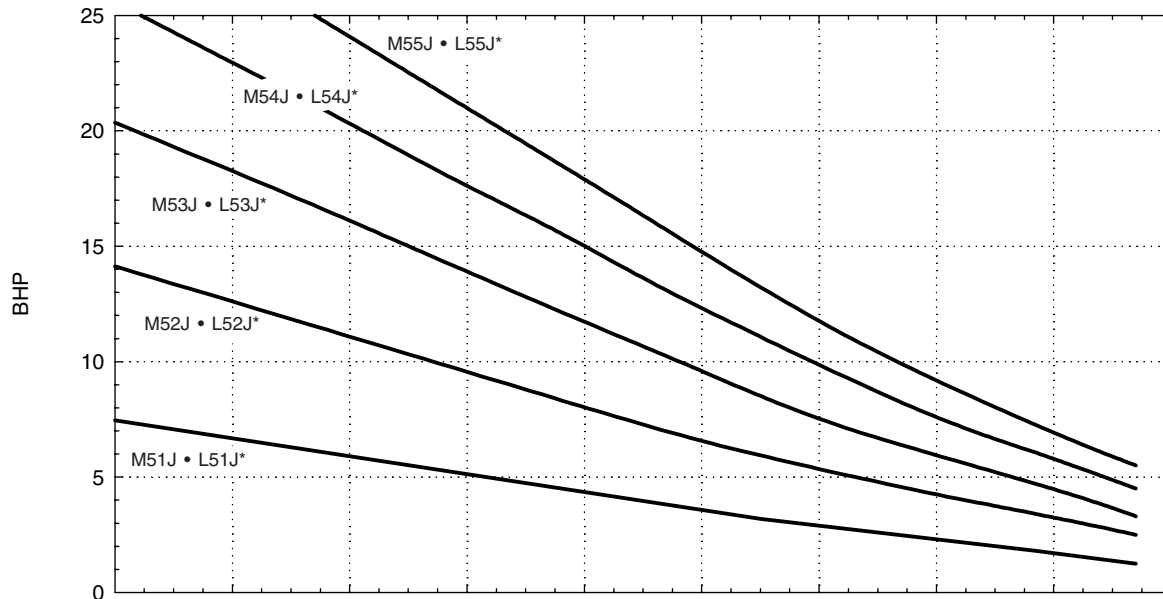
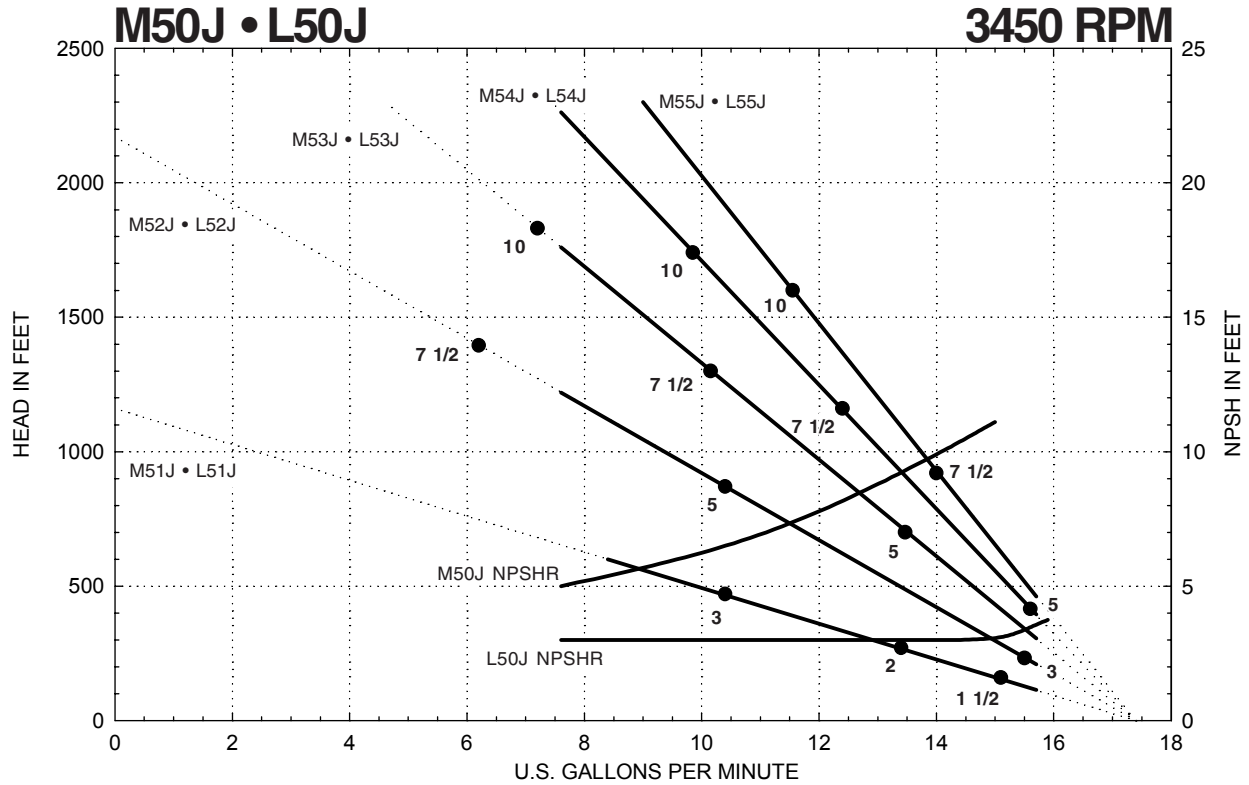

NOTES

- Indicates Motor Horsepower Rating
 Using the Service Factor for Standard MTH Motors
- Usable Operating Range
- ⋯ Refer to Factory for Operation in this Range
- *Add .70 horsepower for L50J Inducer Models
- Horsepower data is valid for 1.0 specific gravity fluids only



MTH PUMPS

401 West Main Street • Plano, IL 60545-1436
 Phone: 630-552-4115 • Fax: 630-552-3688

Performance Curves

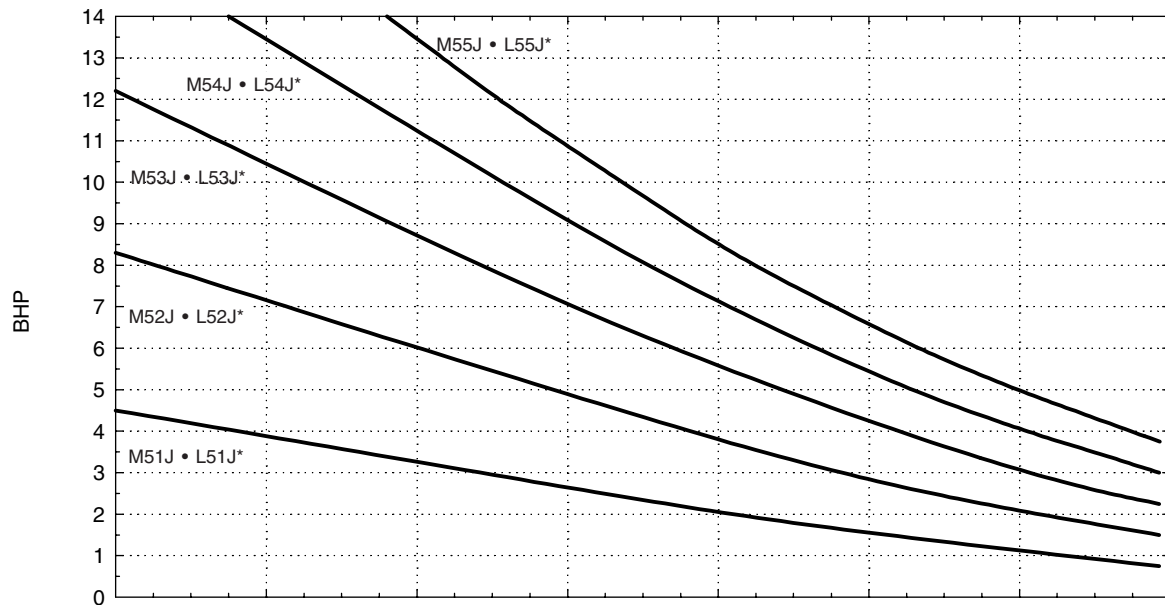
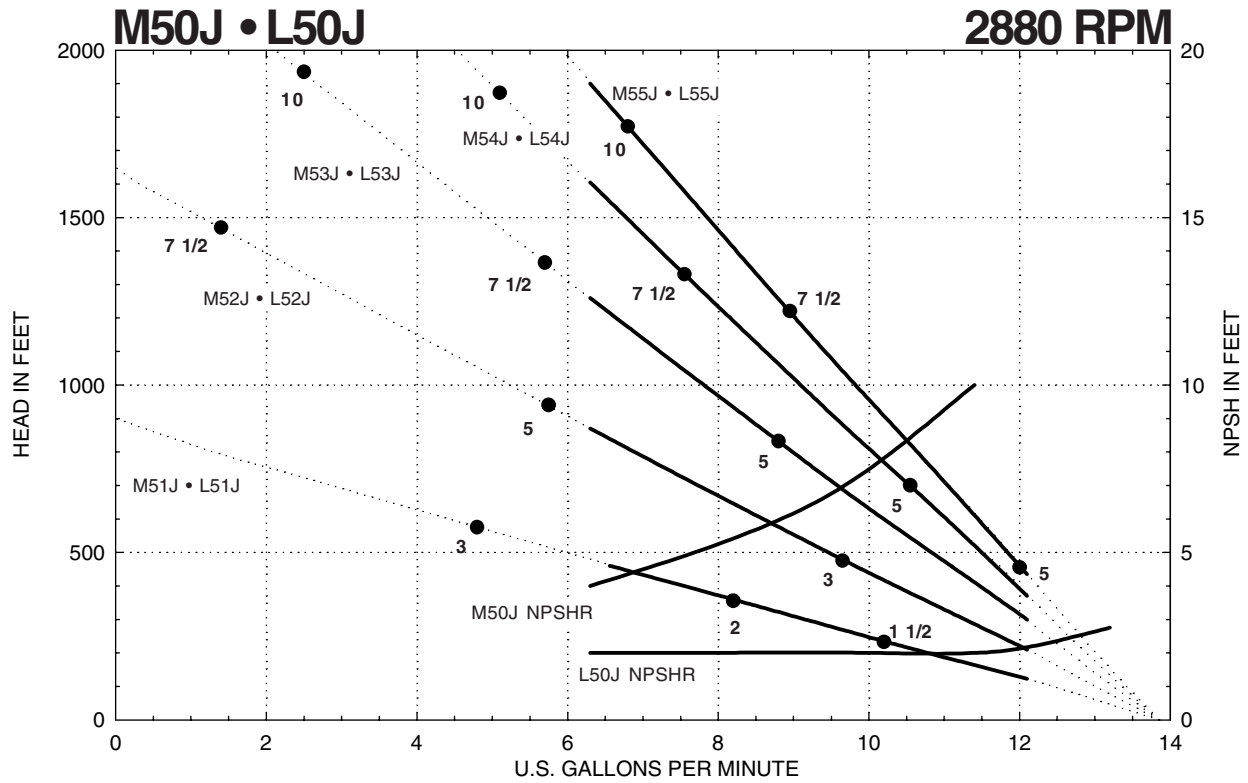

NOTES

- Indicates Motor Horsepower Rating for Standard MTH Motors
- Usable Operating Range
- ⋯ Refer to Factory for Operation in this Range
- *Add .38 horsepower for L50J Inducer Models
- Horsepower data is valid for 1.0 specific gravity fluids only



401 West Main Street • Plano, IL 60545-1436
Phone: 630-552-4115 • Fax: 630-552-3688

M50 • L50 SERIES

Performance Curves

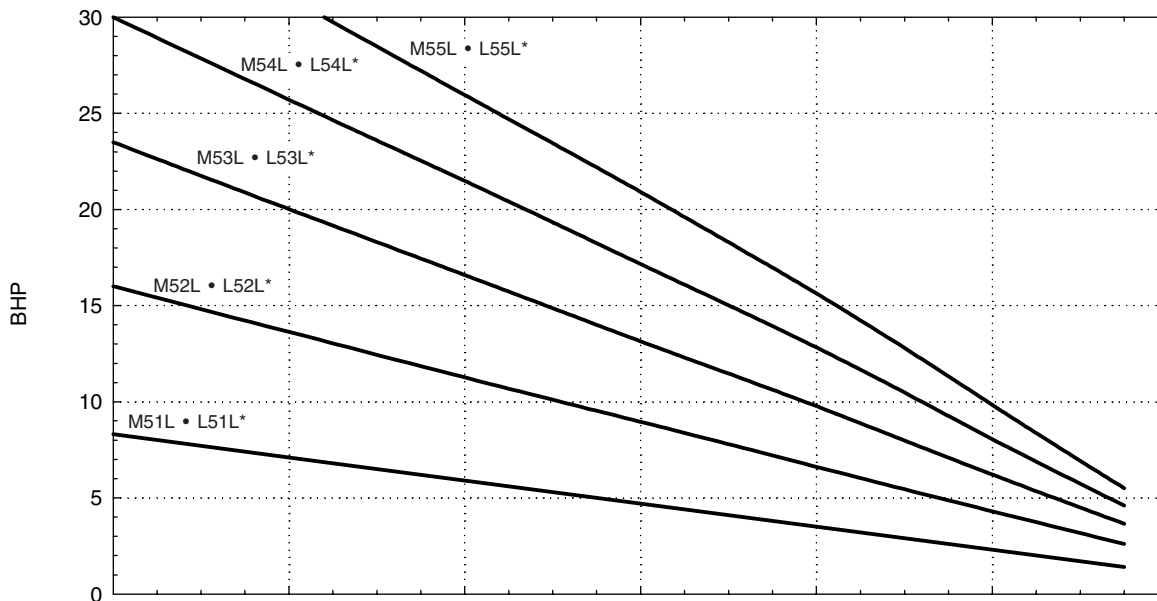
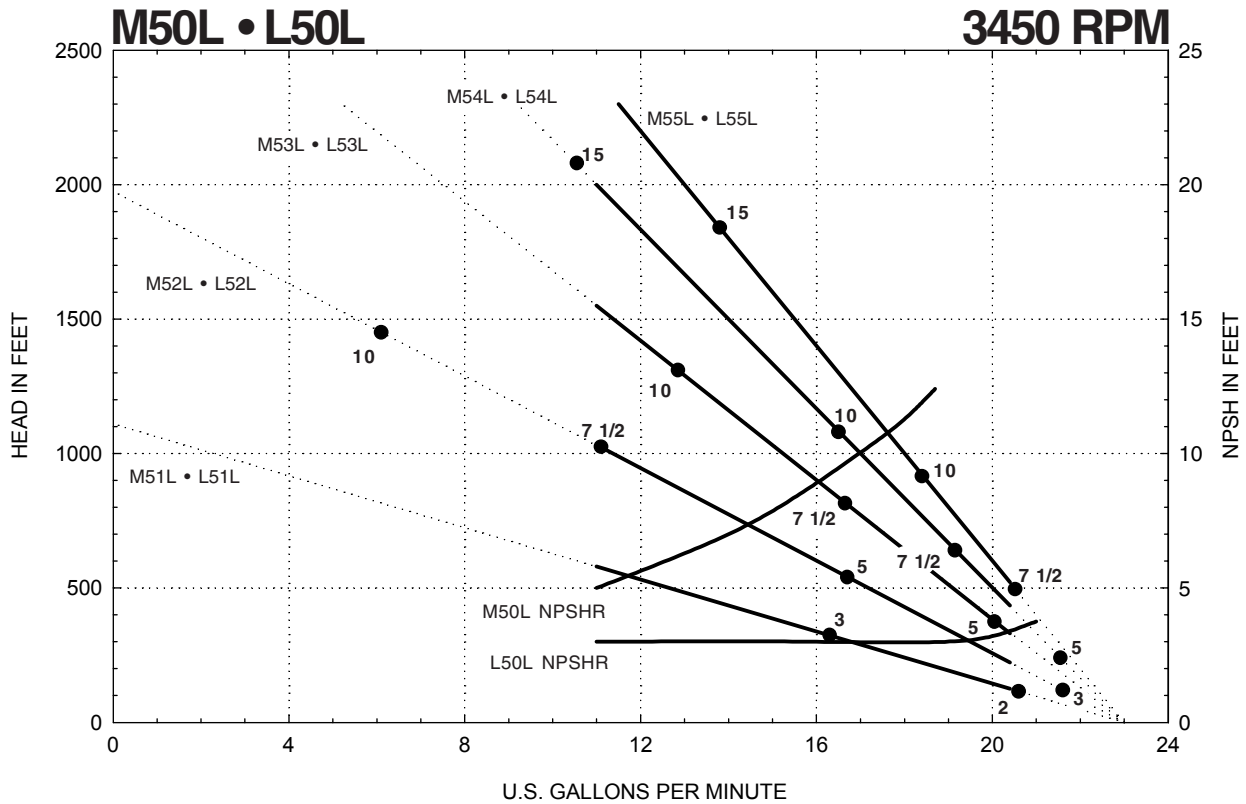

NOTES

- Indicates Motor Horsepower Rating
Using the Service Factor for Standard MTH Motors
- Usable Operating Range
- · · · · Refer to Factory for Operation in this Range
- *Add .81 horsepower for L50L Inducer Models
- Horsepower data is valid for 1.0 specific gravity fluids only



MTH PUMPS

401 West Main Street • Plano, IL 60545-1436
Phone: 630-552-4115 • Fax: 630-552-3688

Performance Curves

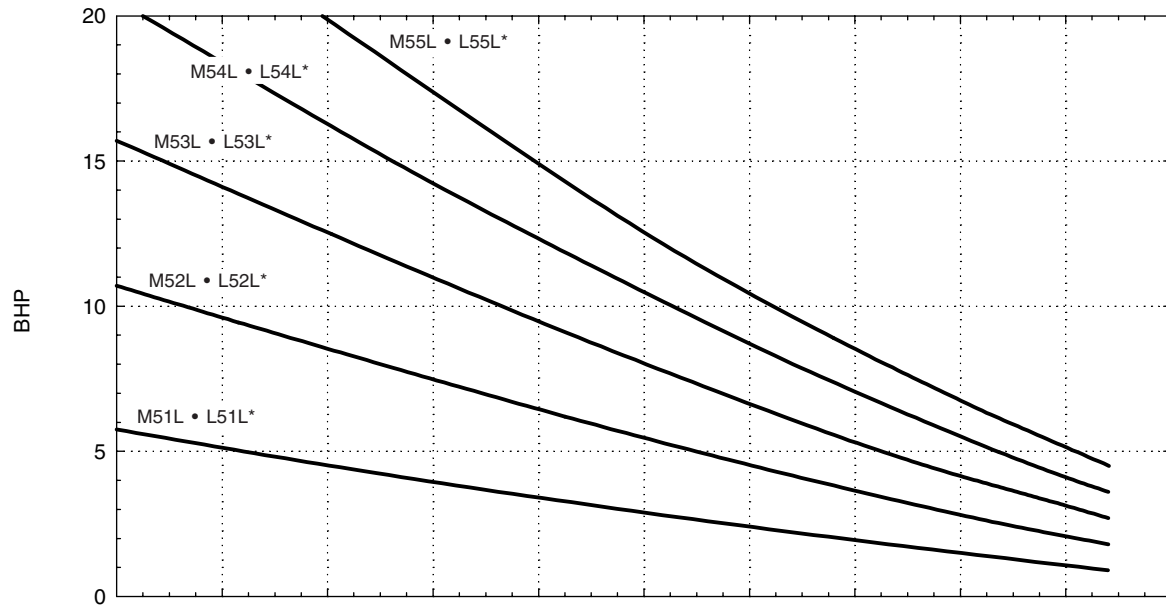
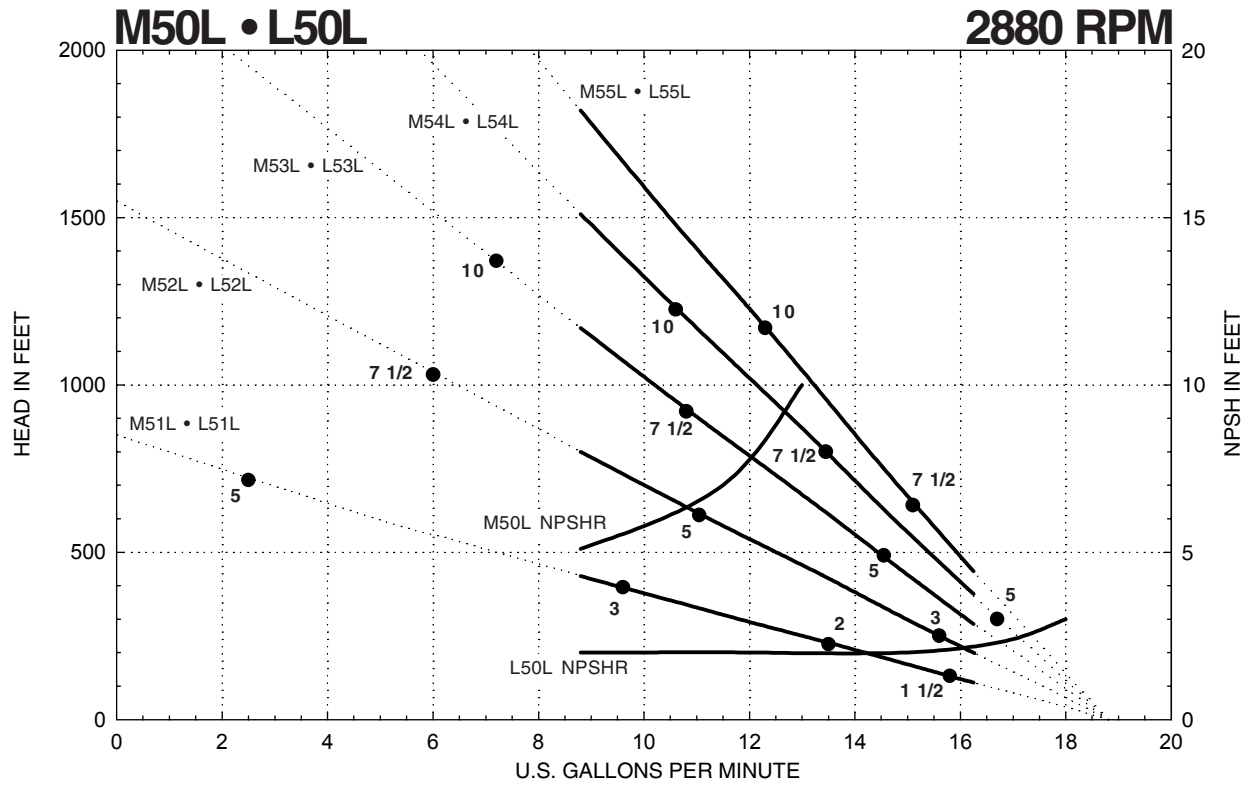

NOTES

- Indicates Motor Horsepower Rating for Standard MTH Motors
- Usable Operating Range
- · · · · Refer to Factory for Operation in this Range
- *Add .43 horsepower for L50L Inducer Models
- Horsepower data is valid for 1.0 specific gravity fluids only



401 West Main Street • Plano, IL 60545-1436
Phone: 630-552-4115 • Fax: 630-552-3688

M50 • L50 SERIES

Performance Curves

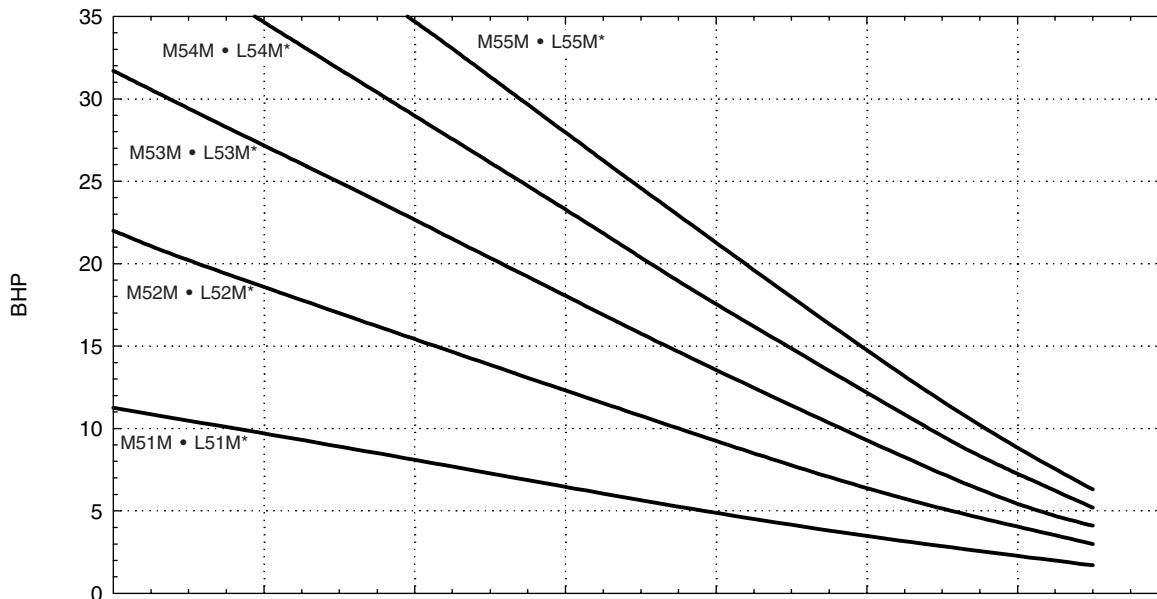
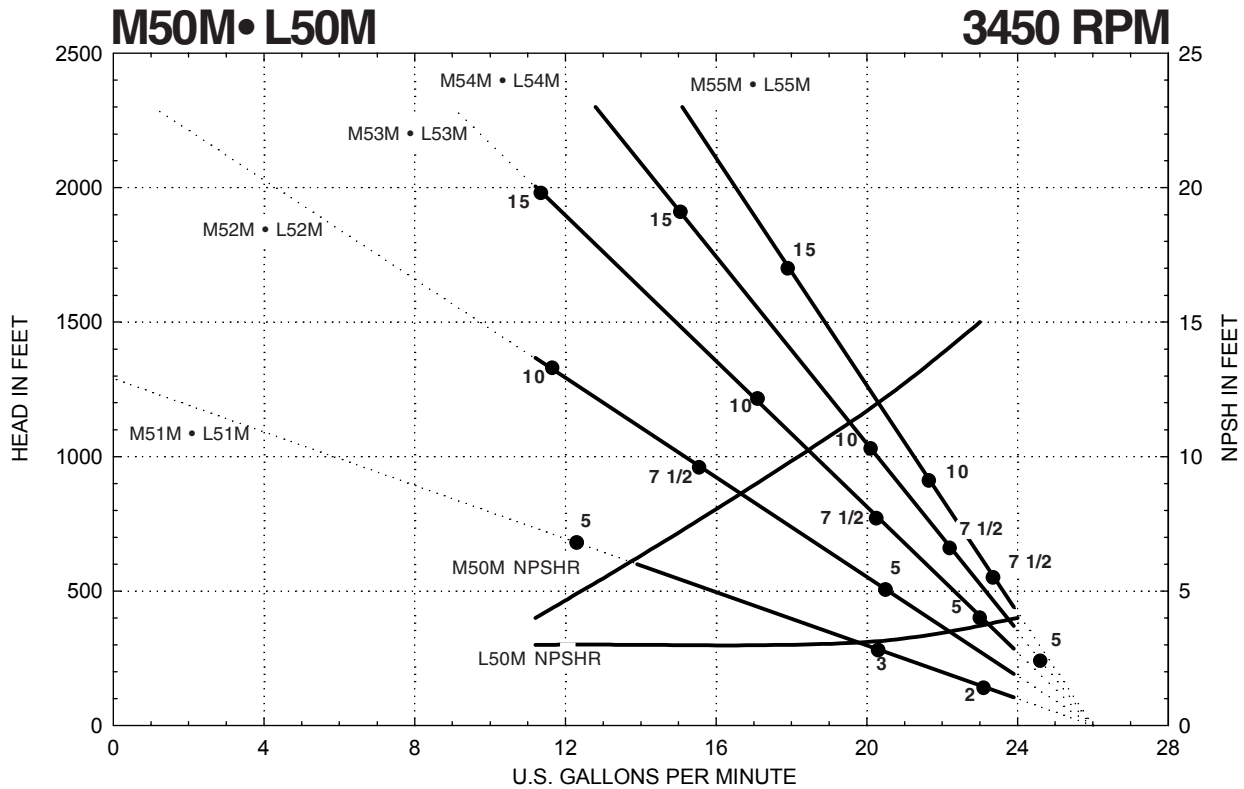

NOTES

- Indicates Motor Horsepower Rating
Using the Service Factor for Standard MTH Motors
- Usable Operating Range
- ⋯ Refer to Factory for Operation in this Range
- *Add .86 horsepower for L50M Inducer Models
- Horsepower data is valid for 1.0 specific gravity fluids only



MTH PUMPS

401 West Main Street • Plano, IL 60545-1436
Phone: 630-552-4115 • Fax: 630-552-3688

Performance Curves

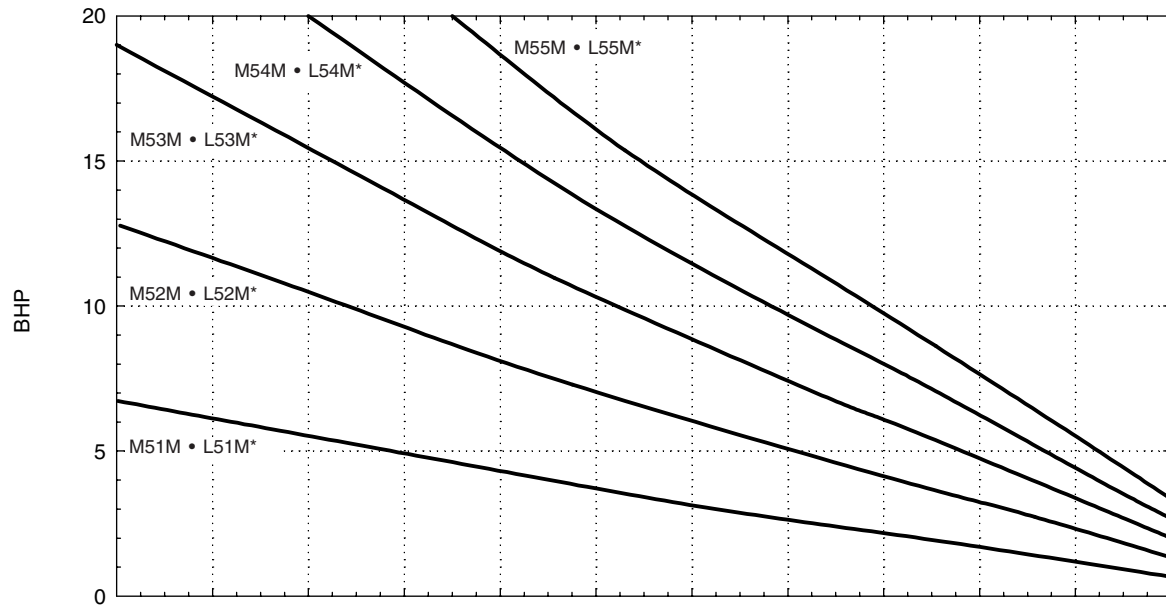
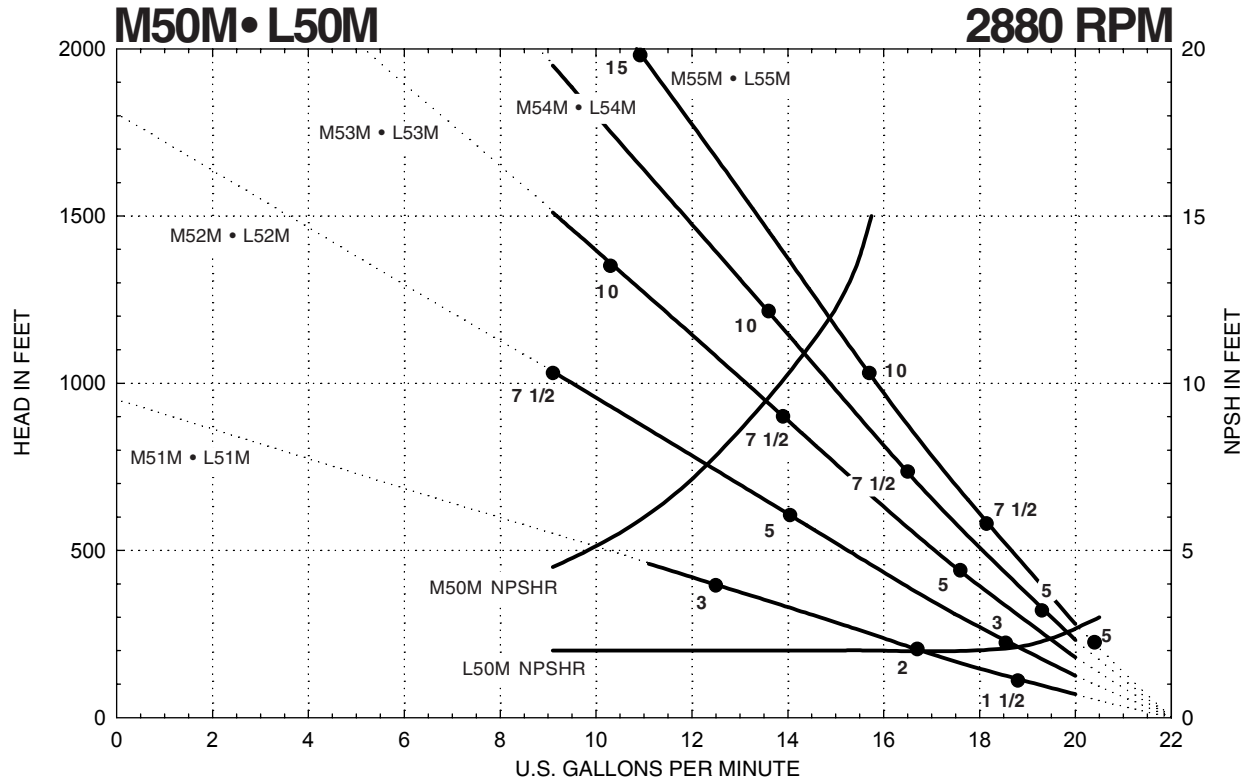

NOTES

- Indicates Motor Horsepower Rating for Standard MTH Motors
- Usable Operating Range
- · · · · Refer to Factory for Operation in this Range
- *Add .46 horsepower for L50M Inducer Models
- Horsepower data is valid for 1.0 specific gravity fluids only



401 West Main Street • Plano, IL 60545-1436
Phone: 630-552-4115 • Fax: 630-552-3688

M50 • L50 SERIES

Performance Curves

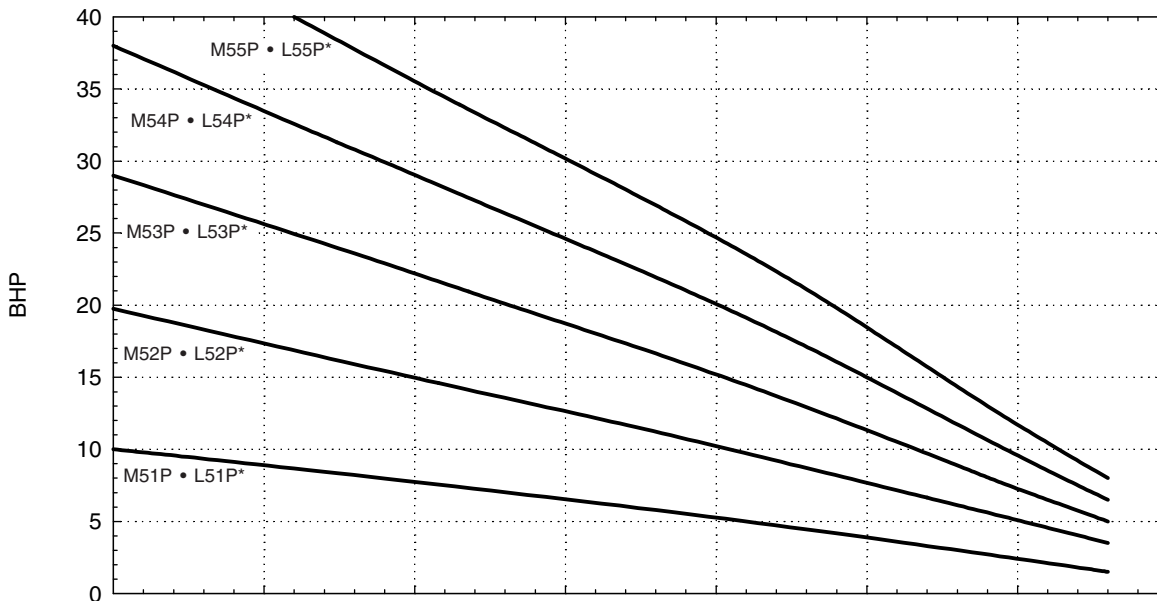
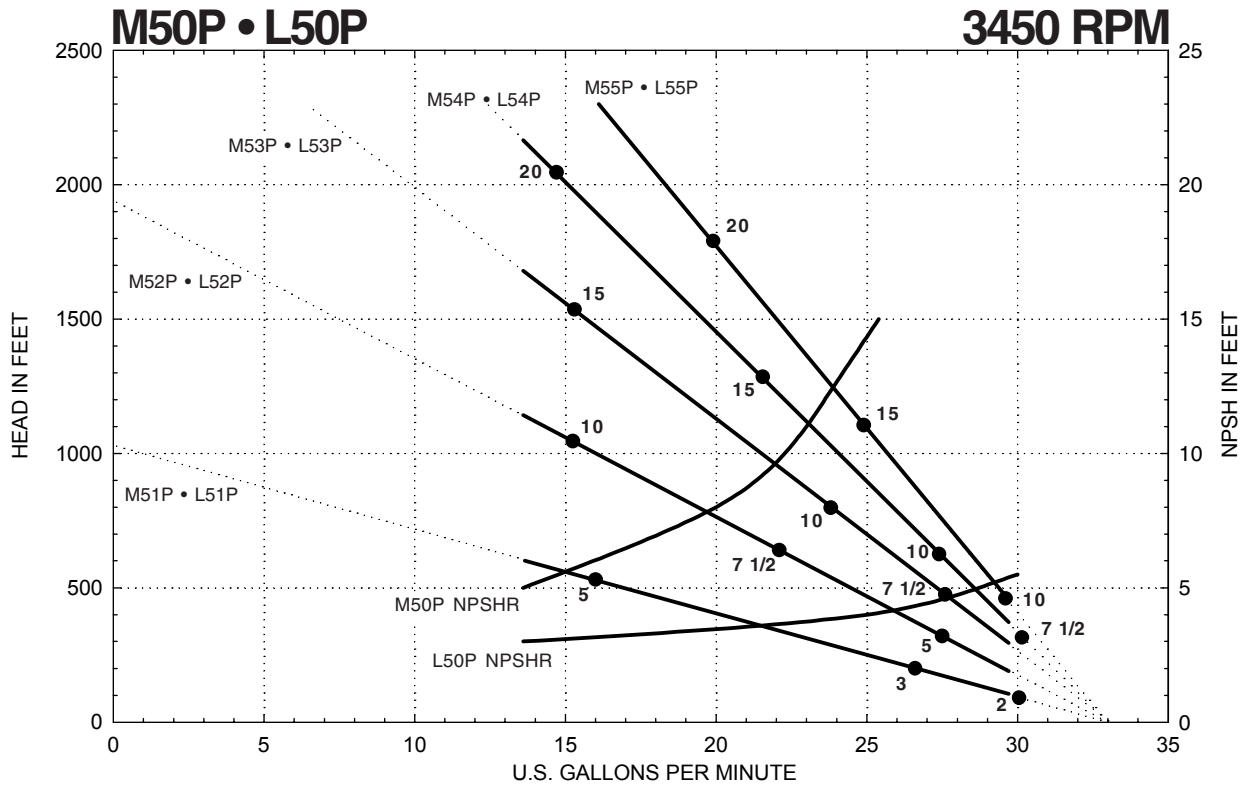

NOTES

- Indicates Motor Horsepower Rating
 Using the Service Factor for Standard MTH Motors
- Usable Operating Range
- · · · · Refer to Factory for Operation in this Range
- *Add .97 horsepower for L50P Inducer Models
- Horsepower data is valid for 1.0 specific gravity fluids only



MTH PUMPS

401 West Main Street • Plano, IL 60545-1436
 Phone: 630-552-4115 • Fax: 630-552-3688

Performance Curves

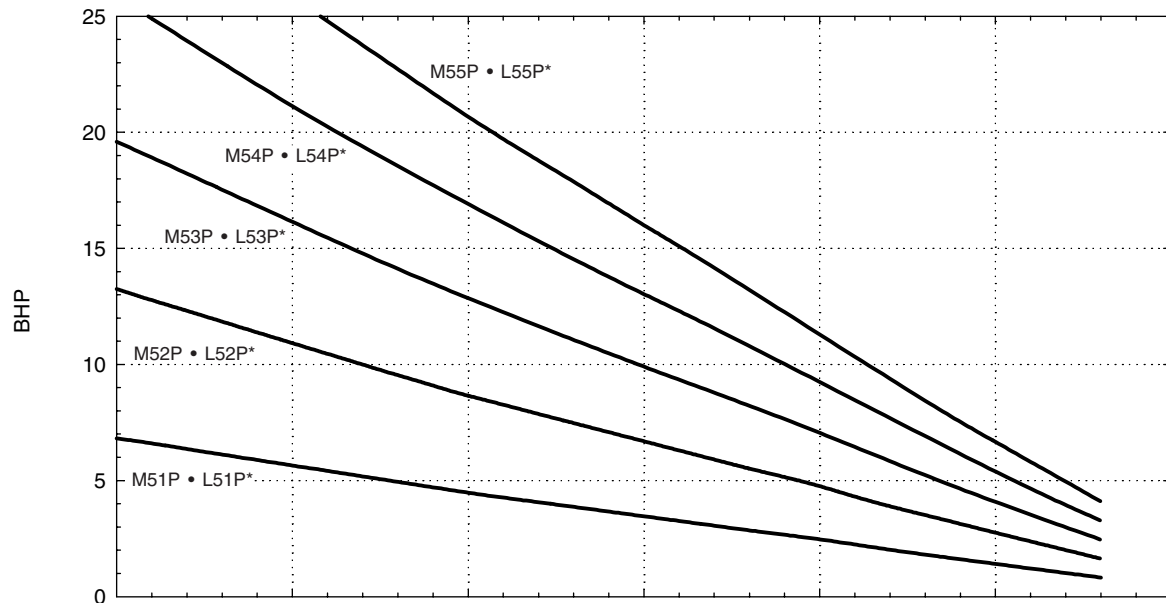
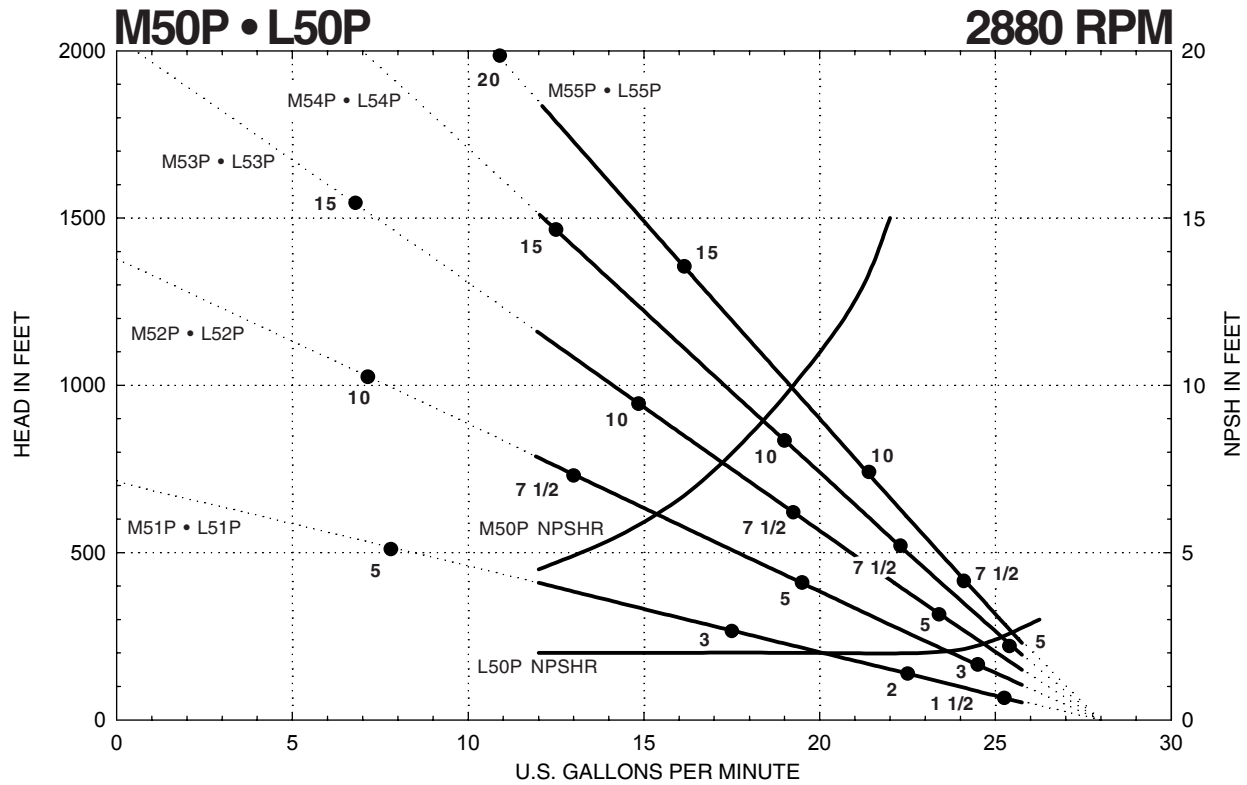

NOTES

- Indicates Motor Horsepower Rating for Standard MTH Motors
- Usable Operating Range
- ⋯ Refer to Factory for Operation in this Range

*Add .53 horsepower for L50PO Inducer Models
Horsepower data is valid for 1.0 specific gravity fluids only



401 West Main Street • Plano, IL 60545-1436
Phone: 630-552-4115 • Fax: 630-552-3688

M50 • L50 SERIES

Performance Curves

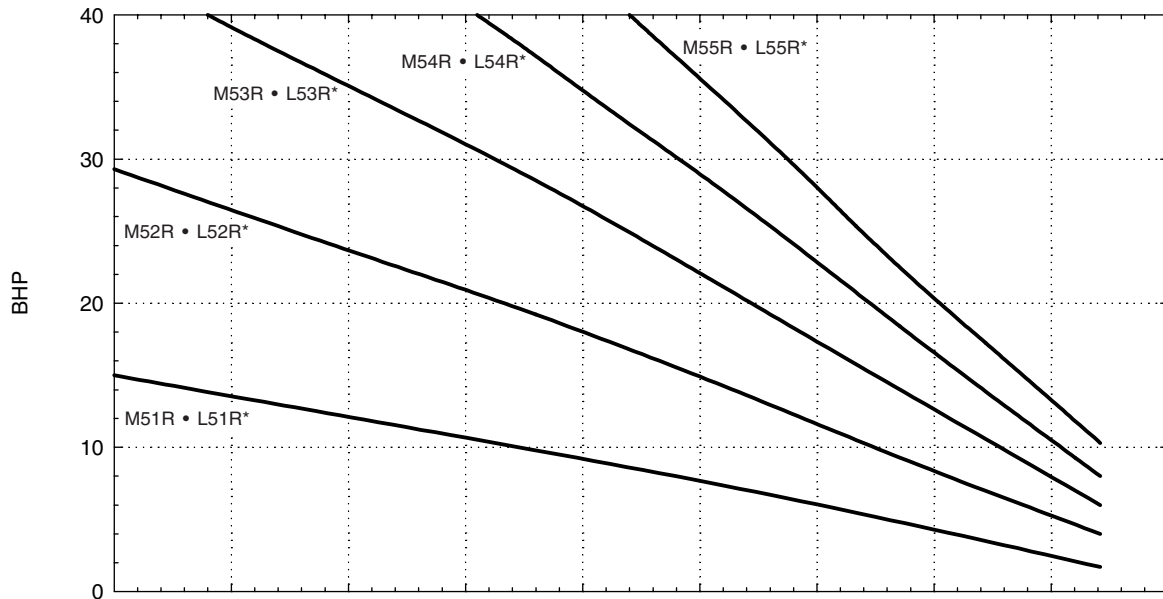
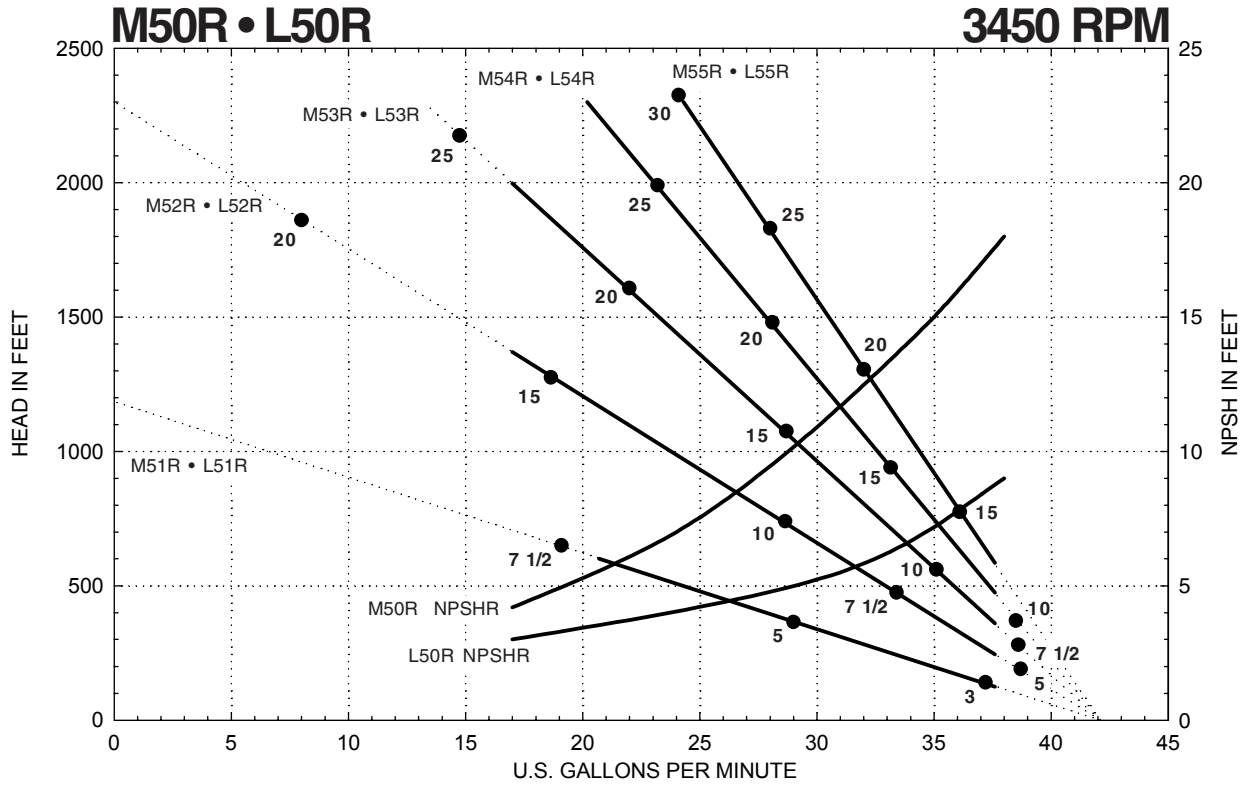

NOTES

- Indicates Motor Horsepower Rating
 Using the Service Factor for Standard MTH Motors
- Usable Operating Range
- · · · · Refer to Factory for Operation in this Range
- *Add 1.08 horsepower for L50R Inducer Models
- Horsepower data is valid for 1.0 specific gravity fluids only



MTH PUMPS

401 West Main Street • Plano, IL 60545-1436
 Phone: 630-552-4115 • Fax: 630-552-3688

Performance Curves

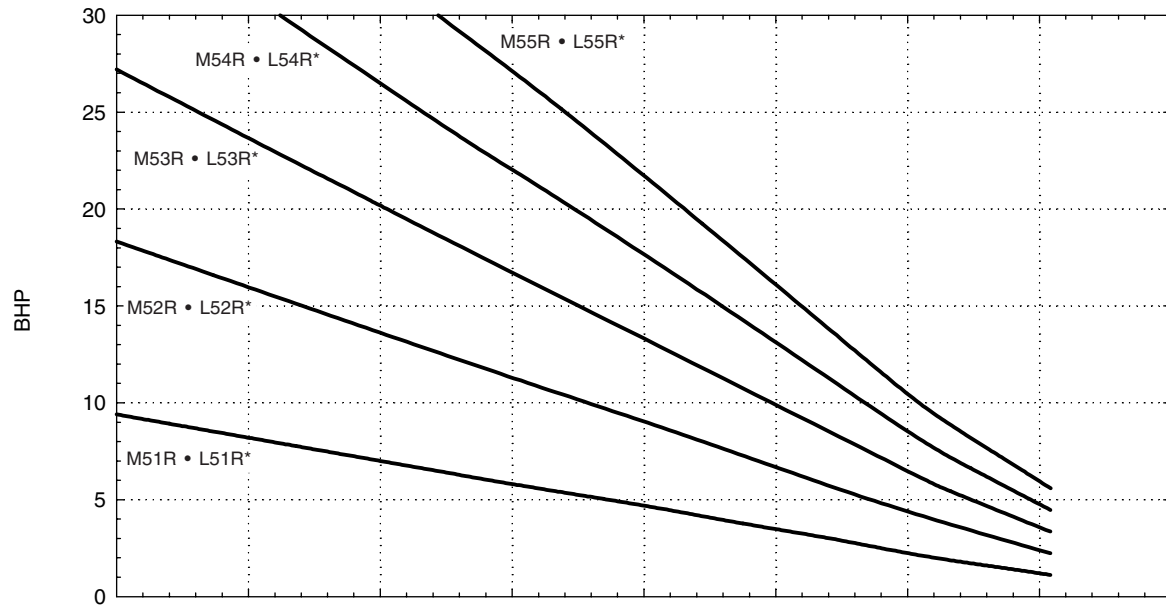
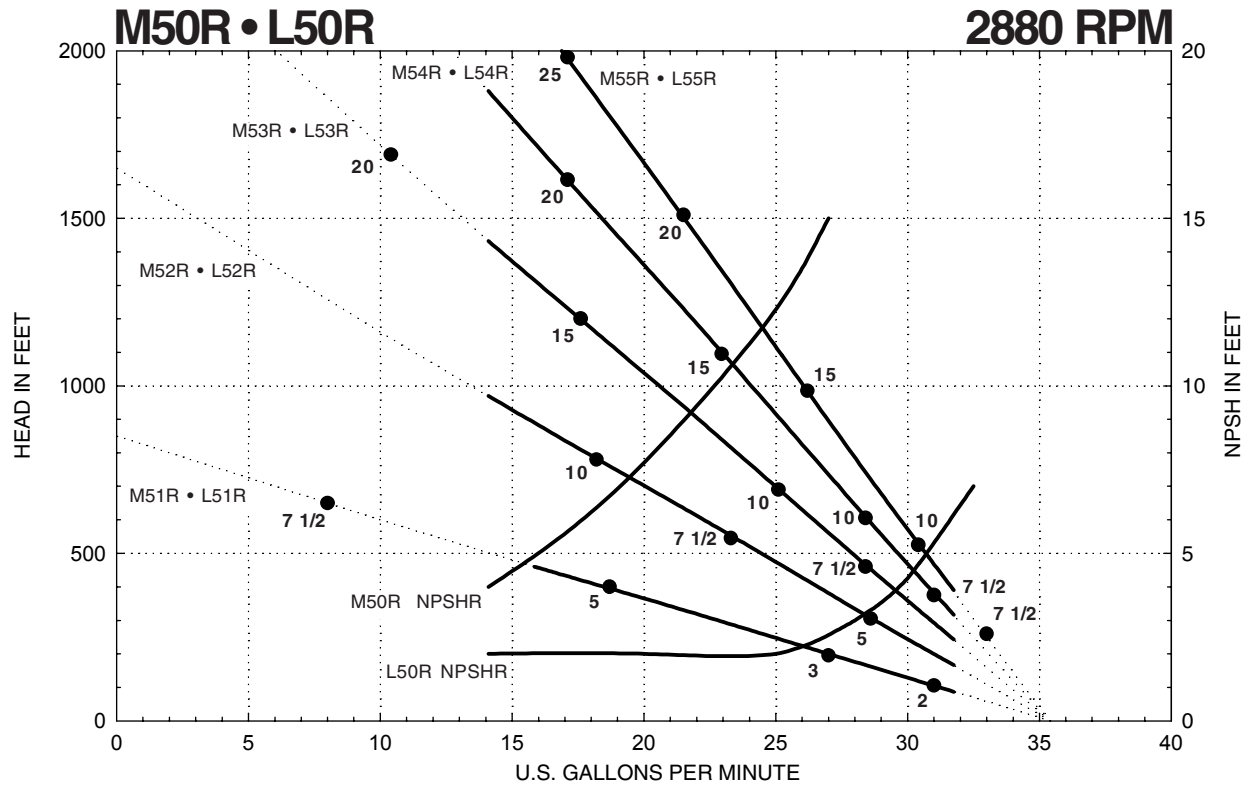

NOTES

- Indicates Motor Horsepower Rating for Standard MTH Motors
- Usable Operating Range
- ⋯ Refer to Factory for Operation in this Range
- *Add .61 horsepower for L50R Inducer Models
- Horsepower data is valid for 1.0 specific gravity fluids only



401 West Main Street • Plano, IL 60545-1436
Phone: 630-552-4115 • Fax: 630-552-3688