



# MARCH PUMPS

1819 PICKWICK AVE., GLENVIEW, IL 60026-1306, U.S.A  
 PHONE: (847) 729-5300 - FAX: (847) 729-7062  
 WWW.MARCHPUMP.COM

AC-5C-MD, TE-5C-MD  
 AC-5A-MD, TE-5A-MD  
 TE-5K-MD  
 TE-5S-MD

### MODEL ABBREVIATIONS:

TE = Totally Enclosed Fan Cooled Motor, AC = Air Cooled Motor  
 5C/5K/5S = Threaded Inlet/Outlet, 5A = Smooth Inlet/Outlet  
 S = Stainless, K = Kynar, C/A = Polypropylene, MD = Magnetic Drive

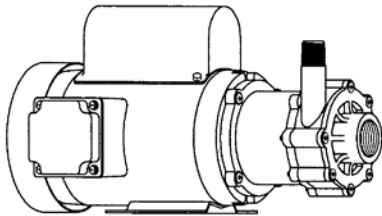

TE-5C-MD & TE-5K-MD

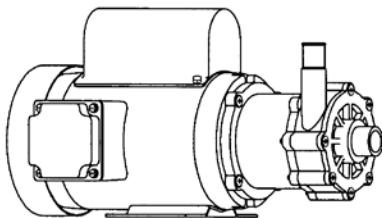

TE-5A-MD

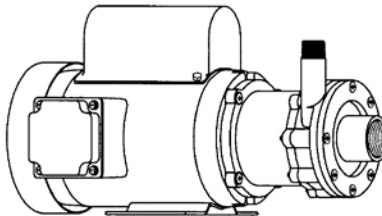

TE-5S-MD

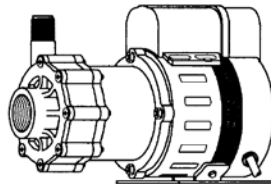

AC-5C-MD

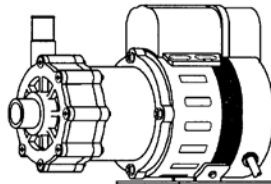

AC-5A-MD

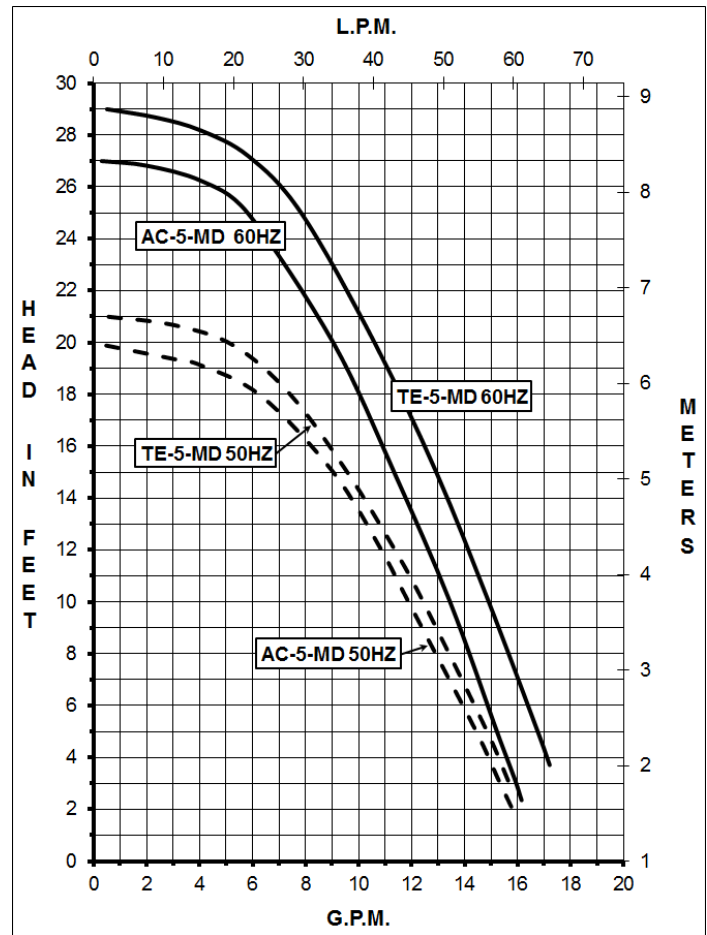

**DESCRIPTION:** Series 5 are centrifugal magnetic drive pumps, eliminating the need for a shaft seal. These pumps can be serviced with a screwdriver. See the repair parts list for a breakdown of replacement parts.

**OPERATION:** These pumps are not self-priming, lack a suction lift, and thus require a flooded suction. These pumps **cannot be run dry** because the impeller requires the liquid being pumped for lubrication. For liquids with a specific gravity greater than water, have a higher viscosity, or for elevated temperatures, a trimmed impeller may be necessary. For application assistance, contact March Pump.

**ELECTRICAL:** AC-5-MD pumps are 115V or 230V, 1 phase, air cooled. TE-5-MD pumps are 115/230V, 1 phase, TEFC. The motors are U.L. listed and rated as continuous duty. Explosion proof and special voltage motors are available on the TE-5-MD upon special order.

**NOTES:** All specifications & data are based on pumping water & are intended as a guideline only. Specifications may vary with different motors.

SPECIFICATIONS		AC-5C-MD	AC-5A-MD	TE-5C-MD	TE-5A-MD	TE-5K-MD	TE-5S-MD
Max Flow	50Hz	lpm	60	60	60.5	60.5	60.5
	60Hz	gpm	17	17	18	18	18
Max Head	50Hz	m	6	6	6.3	6.3	6.3
	60Hz	ft (psi)	27 (11.7)	27 (11.7)	29 (12.5)	29 (12.5)	29 (12.5)
Inlet		1" FPT	1" OD	1" FPT	1" OD	1" FPT	1" FPT
Outlet		1/2" MPT	3/4" OD	1/2" MPT	3/4" OD	1/2" MPT	1/2" MPT
Max Internal Pressure	psi	50	50	50	50	75	200
	bar	3.4	3.4	3.4	3.4	5.0	13
Max Liquid Temperature	°F	190	190	190	190	200	250
	°C	87	87	87	87	93	121
Packed Weight	kg/lbs	4.3/9.5	4.3/9.5	7/15.5	7/15.5	7/15.5	8/18
Motor Type		Air Cooled	Air Cooled	TEFC	TEFC	TEFC	TEFC
		115 or 230	115 or 230	115/230	115/230	115/230	115/230
Phase		1		1		1	
50Hz	Volts	115	230	115	230	110	220
	Watts	214	223	214	223	177	177
	Amps	2.1	1	2.1	1	2.2	1.1
	Kw	0.093	0.093	0.093	0.093	0.149	0.149
	Rpm	2850	2850	2850	2850	2850	2850
60Hz	Volts	115	230	115	230	115	230
	Watts	234	250	234	250	255	255
	Amps	2.1	1	2.1	1	2.1	1.05
	Hp	1/8	1/8	1/8	1/8	0.2	0.2
	Rpm	3450	3450	3450	3450	3450	3450
Electrical Connection		Cord		Conduit Box		Conduit Box	
Overall Pump Dimensions (Inches)	Height	6.19	6.19	7.19	7.19	7.19	7.19
	Width	4.52	4.52	8.02	8.02	8.02	8.02
	Length	9.27	9.83	13	13.56	13	13.31
Overall Pump Dimensions (cm)	Height	15.7	15.7	18.2	18.2	18.2	18.2
	Width	11.4	11.4	20.3	20.3	20.3	20.3
	Length	23.5	24.9	33.0	34.4	33.0	33.8

AC-5C-MD & AC-5A-MD ASSEMBLY

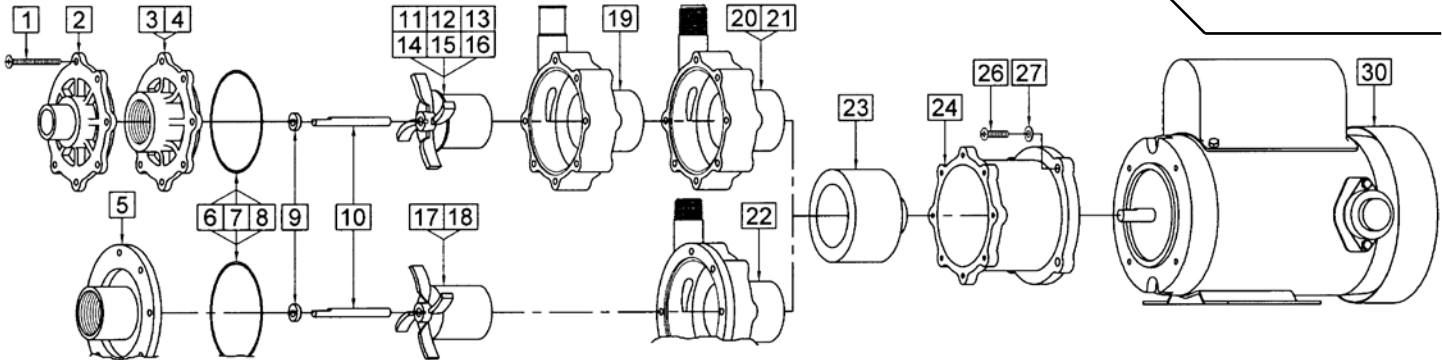
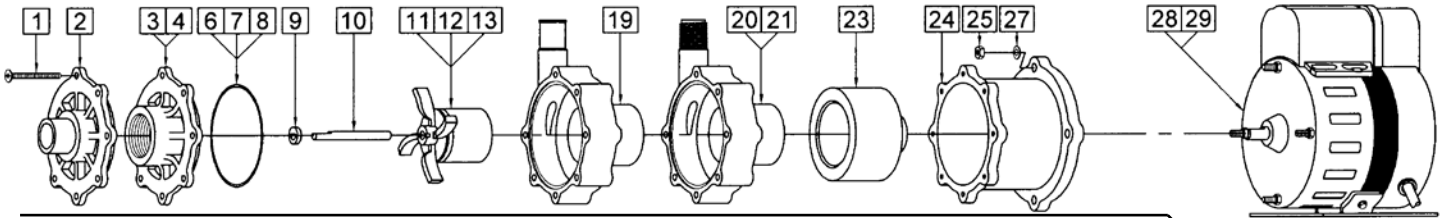

TE-5C-MD, TE-5A-MD, TE-5K-MD, TE-5S-MD ASSEMBLY

**NOTE:** When attaching the Drive Magnet (item 23) to the motor shaft, position the face of the Drive Magnet 3/32 inch below the face of the Motor Bracket (item 24).

REPAIR PARTS LIST

ITEM	DESCRIPTION	SIZE (Inches)	TE-5C-MD, TE-5A-MD TE-5K-MD, TE-5S-MD				AC-5C-MD, AC-5A-MD				AC-5C-MD	AC-5A-MD		
			MATERIAL	QTY.	PART #	TE-5C-MD	TE-5A-MD	TE-5K-MD	TE-5S-MD	MATERIAL			QTY.	PART #
1	Screw	#8-32 x 1-3/4 Lg.	Stainless Steel	7	0150-0021-1000	S	S	S	S	Stainless Steel	7	0150-0021-1000	S	S
2	Cover	1 OD Inlet	Polypropylene	1	0150-0150-1000	O	S			Polypropylene	1	0150-0150-1000	S	O
3	Cover	1 FPT Inlet	Polypropylene	1	0150-0032-1000	S	O			Polypropylene	1	0150-0032-1000	O	S
4	Cover	1 FPT Inlet	Kynar	1	0150-0124-1000			S						
5	Cover	1 FPT Inlet	316 Stainless	1	0150-0111-0000			S						
6	"O" Ring	1/16 CS x 3 OD	Viton	1	0135-0023-1000	S	S	S	S	Viton	1	0135-0023-1000	O	O
7	"O" Ring	.070 CS x 3-1/8 OD	Viton/Teflon	1	0150-0171-1000	O	O	O	O	Viton/Teflon	1	0150-0171-1000	O	O
8	"O" Ring	1/16 CS x 3 OD	Buna N	1	0135-0007-1000	O	O	O	O	Buna N	1	0135-0007-1000	S	S
9	Thrust Washer		Ceramic	1	0130-0028-1000	S	S	S	S	Ceramic	1	0130-0028-1000	S	S
10	Shaft		Ceramic	1	0130-0024-1000	S	S	S	S	Ceramic	1	0130-0024-1000	S	S
11	Impeller		Polypropylene	1	0150-0098-0200	S	S	O		Polypro./Ceramic Mag	1	0150-0030-0100	S	S
12	Impeller w/Carbon Bushing		Polypropylene	1	0150-0098-0300	O	O	O		Polypro./Ceramic Mag	1	0150-0030-0700	O	O
13	Impeller w/Mica Teflon Bushing		Polypropylene	1	0150-0098-0500	O	O	O		Polypro./Ceramic Mag	1	0150-0030-0800	O	O
14	Impeller		Kynar	1	0150-0125-0200			S	O					
15	Impeller w/Carbon Bushing		Kynar	1	0150-0125-0300			O	O					
16	Impeller w/Mica Teflon Bushing		Kynar	1	0150-0125-0500			O	O					
17	Impeller w/Carbon Bushing		316 Stainless	1	0150-0114-0400			S						
18	Impeller w/Mica Teflon Bushing		316 Stainless	1	0150-0114-0600			O						
19	Rear Housing w/Thrust Washer	3/4 OD Outlet	Polypro./Ceramic	1	0150-0159-0100	O	S			Polypro./Ceramic	1	0150-0159-0100	O	S
20	Rear Housing w/Thrust Washer	1/2 MPT Outlet	Polypro./Ceramic	1	0150-0031-0100	S	O			Polypro./Ceramic	1	0150-0031-0100	S	O
21	Rear Housing w/Thrust Washer	1/2 MPT Outlet	Kynar/Ceramic	1	0150-0123-0100			S						
22	Rear Housing	1/2 MPT Outlet	316 Stainless	1	0150-0110-0000			S						
23	Drive Magnet			1	0150-0176-0300	S	S	S	S		1	0150-0081-0100	S	S
24	Motor Bracket		Plastic	1	0150-0070-0100	S	S	S	S		1	0150-0070-0100	S	S
25	Nut (Hex)	#10-32								Stainless Steel	4	0625-0024-1000	S	S
26	Screw	#10-32 x 3/4 Lg.	Stainless Steel	4	0150-0050-1000	S	S	S	S					
27	Washer	#10	Stainless Steel	4	0150-0051-1000	S	S	S	S	Stainless Steel	4	0802-0006-1000	S	S
28	Motor, 115V, 50/60Hz										1	0150-0027-1000	S	S
29	Motor, 230V, 50/60Hz										1	0150-0040-1000	S	S
30	Motor, TEFC, 115/230V			1	0150-0090-1000	S	S	S	S					

NOTE: Contact Factory for other materials and/or parts not listed.

Legend: S = Standard, O = Optional

**MATERIALS IN CONTACT WITH SOLUTION:**

TE-5C-MD & TE-5A-MD: Polypropylene, Viton, Ceramic  
 TE-5K-MD: Kynar/Carbon Filled, Viton, Ceramic  
 TE-5S-MD: 316 Stainless Steel, Viton, Ceramic, Carbon  
 AC-5C-MD & AC-5A-MD: Polypropylene, Ceramic, Buna-N and Ceramic Magnet.

**LIMITED WARRANTY:** March pumps are guaranteed only against defects in workmanship or materials for a period of one year from date of manufacture pumping water. For the complete warranty and to register online go to [www.marchpump.com/warranty-registration](http://www.marchpump.com/warranty-registration)