



**MODELS: 6400-SERIES
7420-SERIES**

a xylem brand

SELF-PRIMING PUMPS

FEATURES

Body:	Bronze
Impeller:	Neoprene
Shaft:	Type 316 Stainless Steel
Wearplate:	Replaceable
Shaft Seal:	Carbon-Ceramic Face Type
Bearing:	Pre-lubricated Double Row Ball
Ports:	1-1/4" (32mm) NPT Internal
Weight:	10-1/2 lb (4.8 kg) Approx.

VARIATIONS AVAILABLE

MODEL NO.	DESCRIPTION
6400-0004	Full Thickness Cam, Neoprene Impeller, Standard Shaft
6400-0051	Half Thickness Cam, Neoprene Impeller, Standard Shaft
6400-1051	Half Thickness Cam, Neoprene Impeller, Short S.S. Shaft for Caterpillar Engines
7420-0004	Full Thickness Cam, Neoprene Impeller, Standard Shaft
7420-1001	Full Thickness Cam, Neoprene Impeller, Short S.S. Shaft for Caterpillar Engines

APPLICATIONS

MARINE: Pumping bilges, Washdown, Engine Cooling.

INDUSTRIAL: Circulating and Transferring liquids; Velocity-mixing; Transferring soap, liquors, pastes, glues, glycerine, lotions and brine.

FARM: Pumping water for stock and poultry houses and Booster Pumping.

PLUMBING & HOME: Pumping out flooded basements, cesspools, sumps and many other uses.

OPERATING INSTRUCTIONS

- INSTALLATION** - Pump may be mounted in any position. The rotation of the pump shaft determines the location of the pump's intake and discharge ports. (Refer to dimensional drawing.) Pump is normally assembled at factory for clockwise rotation (looking at end cover). If counter clockwise rotation is desired, follow steps 1 and 2 of disassembly and step 12 of assembly instructions to change direction of impeller blade deflection under cam.
- DRIVE** - Belt or Direct with flexible coupling.
BELT DRIVE - Overtight belt load will reduce bearing life.



6400-Series



7420-Series

Models 6400-Series, 7420-Series

WARNING



Injury hazard. Exposed pulleys and belts can cause injury. Install shield around pulleys and belts. Stay clear while machinery is operating.

DIRECT DRIVE - Clearance should be left between drive shaft and pump shaft when installing coupling. Always mount and align pump and drive shaft before tightening the coupling set screw.

NOTICE: If drive pulley or coupling must be pressed on shaft, remove end cover and impeller and support shaft from impeller end during press operation. Do not hammer a pulley or coupling on shaft. Failure to follow above instructions can damage the pump.

OPERATING INSTRUCTIONS (Continued)

3. SPEEDS - 100 RPM to the maximum shown in the performance table. For longer pump life, operate at lowest possible speeds.
4. SELF-PRIMING - Primes at low or high speeds. For vertical dry suction lift of 10 feet, (3.1m) a minimum of 800 RPM is required. Pump will produce suction lifts up to 22 (6.7m) feet when wetted. BE SURE SUCTION LINES ARE AIRTIGHT.
5. RUNNING DRY - Unit depends on liquid pumped for lubrication. DO NOT RUN DRY for more than 30 seconds. Lack of liquid will damage the impeller.
6. NOTICE – If pumping light fraction petroleum derivatives, solvents, thinners, highly concentrated or organic acids, consult Jabsco “Chemical Resistance Table” (which is available upon request from Jabsco) for proper body materials and impeller compounds. If corrosive fluids are handled, pump life will be prolonged if pump is flushed with water after each use or after each work day.
7. PRESSURES – For continuous operation, pressure should not exceed 30 psi (2.1 kg/sq cm). For intermittent service only, pressures from 35 to 50 psi (2.5 – 3.5 kg/sq cm) can be attained using 807-1001 impeller, plus an extra gasket.
8. TEMPERATURES –
Neoprene: 45°-180° F (7°-82° C)
Nitrile: 50°-180° F (10°-82° C)
Natural Rubber: 33°-120° F (0.6°-49° C)
9. FREEZING TEMPERATURES – Drain unit by loosening end cover. The following anti-freeze compounds can be used without any adverse effect to the neoprene impeller: Atlas “Permaguard”, DuPont “Zerex” and “Telar”, Dow Chemical “Downguard” and Olin Mathison “Pyro”. Most methyl alcohol (methanol) based anti-freezes can be used. DO NOT USE PETROLEUM BASED ANTI-FREEZE COMPOUNDS OR RUST INHIBITORS.
10. GASKET – Use standard pump part. A thicker gasket will reduce priming ability. A thinner gasket will cause impeller to bind. Standard gasket is 0.015" thick.
11. SPARE PARTS – To avoid costly shut downs, keep a Jabsco Service Kit on hand.

SERVICE INSTRUCTIONS

DISASSEMBLY

1. Remove end cover screws, end cover and gasket.
2. Remove impeller (and O-ring on -10XX pumps only).
3. Remove seal with hooked wire. Remove seal seat and gasket.
4. Loosen cam screw and remove cam. Clean off sealant.
5. Remove wearplate.

6. Insert screwdriver between OD of outer bearing seal and pump bore and pry out seal.
7. Remove bearing to body retaining ring.
8. Press on impeller drive end of shaft to remove shaft and bearing assembly. Heating outside of body at bearing will ease disassembly.
9. Remove bearing-to-shaft retaining ring.
10. Supporting bearing inner race, press shaft through bearing.
11. Using extreme care not to mar bore, insert screwdriver between OD of inner seal and pump bore and pry out the seal.
NOTE: Inspect all parts for wear or damage and replace if necessary.

ASSEMBLY

1. Lubricate inner seal with grease and press into body bearing seal bore with lip facing away from bearing bore.
2. Press shaft into bearing, using care to support inner race of bearing.
3. Install bearing-to-shaft retaining ring with flat side toward bearing.
4. Position slinger in body drain area on 6400-Series pumps only. Insert splined end of shaft through bearing bore and guide slinger over shaft until bearing contacts body.
5. Pressing on bearing outer race, install bearing and shaft assembly into bore.
6. Install bearing to body retaining ring in body groove with flat side toward bearing.
7. Lubricate outer bearing seal with grease and press into bearing bore until it is flush with the body.
8. Install wearplate in body bore, aligning slot in wearplate with dowel pin in body.
9. Apply a thin coat of sealant to cam screw threads and top side of cam and install in body.
10. Lubricate seal seat assembly with water and insert in seal bore of body with polished surface facing outward. Care must be taken not to mar or scratch seal seat face. Installing this assembly with a slight rotary motion will insure seating the gasket firmly in the cavity.
11. Slide carbon ring assembly, with carbon facing ceramic, over the shaft and firmly up against the ceramic seat.
12. Slide O-ring onto shaft and position in the O-ring groove at the base of the spline (-10XX series pumps only).
13. Lubricate impeller bore with a light coat of water pump grease and start impeller into bore with a rotary motion until splines engage, then push into bore.
14. Install gasket and end cover and secure with end cover screws.

EXPLODED VIEW

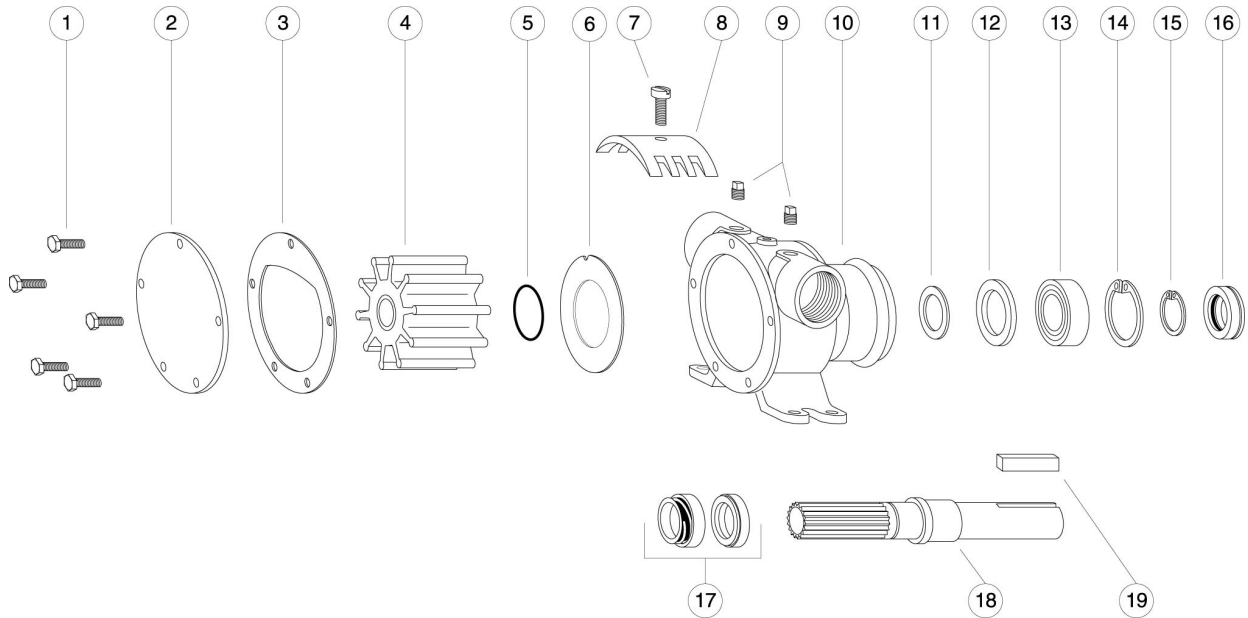

PARTS LIST

Model 6400-0004
Model 7420-0004

Key	Description	Qty. Req.	Part Number
1	Screw, End Cover	5	91005-0040
2	End Cover	1	12062-0000
3	*Gasket for Full Thickness Cam for Half Thickness Cam	1	816-0000 2553-0000
4	*Impeller (St'd) Neoprene (Opt'l) Nitrile (Opt'l) High Pressure (Opt'l) Natural Rubber	1	17935-0001 836-0003 807-1001 836-0008
5	O-Ring -10XX series pumps only	1	92000-0120
6	Wearplate	1	2574-0000
7	Screw, Cam for Full Thickness Cam for Half Thickness Cam	1	91005-0040 91005-0050
8	Cam, Full Thickness Half Thickness	1	834-0001 2551-0000
9	Pipe Plug, 1/4" -10XX series pumps only	2	92650-0070
10	Body, Sub Ass'y (6400) Body, Sub Ass'y (7420)	1 1	18753-0585 7424-0000
11	Slinger (6400-Series only)	1	3181-0000
12	Bearing Seal (inner)	1	817-0000
13	Ball Bearing	1	92600-0040
14	Retaining Ring (Brg. to Body)	1	18712-0000
15	Retaining Ring (Brg. to Shaft)	1	18711-0000
16	Bearing Seal** (outer)	1	818-0000
17	*Seal Assembly **	1	6407-0010
18	Shaft, Std. Length - 316 Stainless Steel Short - S.S. for Caterpillar Pumps 6400-1051 & 7420-1001	1 1	824-0020 824-2001
19	Key 1/4" x 1/4" x 1"	1	9214-0001
-	Service Kit Neoprene Imp.		90062-0001
-	Service Kit Nitrile Imp.		90062-0003

* Parts Included in Service Kit

** When replacing shaft seal, the outer bearing seal is generally distorted during disassembly requiring replacement and is not included in the service kit.

HEAD CAPACITY TABLE

	TOTAL HD.		500 RPM		1160 RPM		1450 RPM		1750 RPM		2100 RPM		2450 RPM		
	P.S.I. (kg/sq cm)	Ft. of Water (metre)	GPM (L/min)	HP	GPM (L/min)	HP	GPM (L/min)	HP	GPM (L/min)	HP	GPM (L/min)	HP	GPM (L/min)	HP	
Standard Pressure Impeller	4.3 (0.3)	10 (3.0)	18 (68.1)	1/2	41 (155.2)	1	51 (193.0)	1 1/2	62 (234.7)	1 1/2	72 (272.5)	3	74 (280.1)	3	
	8.7 (0.6)	20 (6.1)	17 (64.4)	1/2	40 (151.4)	1	50 (189.3)	1 1/2	60 (227.1)	1 1/2	70 (265.0)	3	72 (272.5)	3	
	17.3 (1.2)	40 (12.2)	14 (53.0)	1/2	37 (140.1)	1 1/2	46 (174.1)	1 1/2	55 (208.2)	2	66 (249.8)	3	71 (266.7)	3	
	26.0 (1.8)	60 (18.3)	—	—	32 (121.1)	1 1/2	42 (159.0)	2	50 (189.3)	2	60 (227.1)	3	67 (253.6)	5	
	34.6 (2.4)	80 (24.4)	—	—	—	—	—	35 (132.5)	2	44 (166.5)	2	52 (196.8)	3	60 (227.1)	5
Standard Pressure Impeller	4.3 (0.3)	10 (3.0)	11 (41.6)	1/2	26 (98.4)	3/4	31 (117.3)	1 1/2	37 (140.1)	1 1/2	46 (174.1)	1 1/2	56 (212.0)	2	
	8.7 (0.6)	20 (6.1)	9.5 (36.0)	1/2	24 (90.8)	1	29 (109.8)	1 1/2	35 (132.5)	1 1/2	44 (166.5)	2	52 (196.8)	3	
	17.3 (1.2)	40 (12.2)	5.5 (20.8)	1/2	19 (71.9)	1	23 (87.1)	1 1/2	29 (109.8)	1 1/2	38 (143.8)	2	45 (170.3)	3	
	26.0 (1.8)	60 (18.3)	—	—	12 (45.4)	1 1/2	15 (56.8)	1 1/2	21 (79.5)	1 1/2	31 (117.3)	3	37 (140.1)	3	
Half Thickness Cam	8.7 (0.6)	20 (6.1)	14 (53.0)	3/4	38 (143.8)	1 1/2	50 (189.3)	2	62 (234.7)	3	72 (272.5)	3	74 (280.1)	3	
	17.3 (1.2)	40 (12.2)	10 (37.8)	1	34 (128.7)	1 1/2	44 (166.5)	2	54 (204.4)	3	64 (242.4)	3	71 (266.7)	3	
	26.0 (1.8)	60 (18.3)	8 (30.3)	1	30 (113.6)	2	40 (151.4)	3	50 (189.3)	3	60 (227.1)	3	67 (253.6)	5	
	34.6 (2.4)	80 (24.4)	—	—	28 (106.0)	2	36 (136.3)	3	47 (177.9)	3	57 (216.1)	3	64 (242.4)	5	
	47.8 (3.4)	110 (33.5)	—	—	20 (75.7)	2	28 (106.0)	5	38 (143.8)	5	48 (182.9)	5	57 (216.1)	5	
	60.9 (4.3)	130 (42.7)	—	—	—	—	—	28 (106.0)	5	38 (143.8)	5	48 (182.9)	5	57 (216.1)	5

NOTE: Table shows approximate head-flow for new pump in U.S. gallons per minute and litres per minute. Progressively longer life may be expected as operating pressures and speeds are reduced. Factory Application Engineering assistance is recommended for shaded area. High starting torque motors are required. Pump starting torque in dry condition (no fluid in pump body) is 134 inch-pounds and in wet condition (fluid in pump body) is 105 inch-pounds.

DIMENSIONAL DRAWING† Inches (Millimeters)

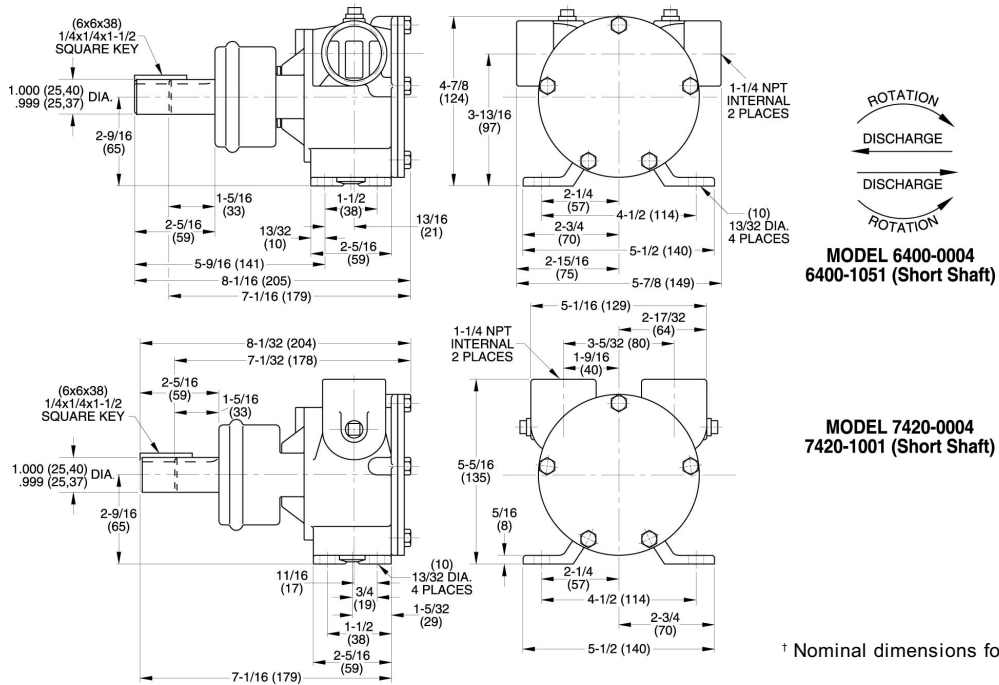

Warranty: All products of the company are sold and all services of the company are offered subject to the company's warranty and terms and conditions of sale, copies of which will be furnished upon request. The information provided herein is for guidance only, it does not constitute a guarantee of the performance or specification of any individual product or component.

www.xylemflowcontrol.com

JabSCO, 100 Cummings Center, Ste. 535-N, Beverly, MA 01915
Tel: +1 978 281 0440 Fax: +1 978 283 2619

JabSCO, Bingley Road, Hoddesdon, Hertfordshire, EN11 0BU
Tel: +44 (0) 1992 450 145 Fax: +44 (0) 1992 467 132

NHK JabSCO Co Ltd, 3-21-10, Shin - Yokohama Kohoku-ku, Yokohama 222
Tel: +81 (0) 45 475 8906 Fax: +81 (0) 45 475 8908

JabSCO GmbH, Oststraße 28, 22844 Norderstedt
Tel: +49 (0) 40 53 53 73 0 Fax: +49 (0) 49 53 53 73 11

JabSCO Italia, s.r.l., Via Tommaso, 6, 20059 Vimercate, Milano
Tel: +39 039 685 2323 Fax: +39 039 666 307

USA

UK

JAPAN

GERMANY

ITALY



a xylem brand