



Lite Flush Electric Toilets

Models 58500-Series

FEATURES

- Space saving stylish design
- Compact size, rotatable seat
- Virtually silent operation
- Choice of leaving bowl wet or dry after use
- Non-clogging large bore flush pump macerates waste
- Uses less than 1.0 amp/hour per day
- ISO 8846 MARINE - Ignition Protection
- Raw water only

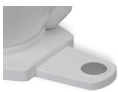
MODEL RANGE

Description		Part no.	Fuse/ Breaker	
	Foot-switch Variant (11 kg, 24 lbs)	Lite Flush 12V	58500-0012	25 amp
		Lite Flush 24V	58500-0024	15 amp
	Control Panel Variant (11kg, 24lbs)	Lite Flush 12V	58500-1012	25 amp
		Lite Flush 24V	58500-1024	15 amp

Foot-switch controller

The lite flush toilet offers a single touch fully automatic foot-switch operation.

- The first press of the foot-switch activates the rinse pump and adds approximately 0.6 Litres, less than 1/5 of a us gallon, of water to the bowl.
- The second press of the foot-switch activates the rinse pump adding a further 0.6 Litres, less than 1/5 of a us gallon, of water to the bowl and then operates the flush pump, discharging the contents and leaving the bowl dry.

This is the complete 2 stage flush cycle. You may decide to leave the bowl dry or, by pressing the foot-switch once more, leave the bowl wet, ready for the next user.

Note: The correct use of the toilet is to;

1. Press the foot-switch and add water to the bowl
2. Use the toilet
3. Press the foot-switch to add water and
4. Then discharge



Touch pad controller

The Lite Flush toilet features a 'one touch' control pad offering two options - 'fill' and 'flush'.



- The user needs to press the 'fill' button first to activate the rinse pump and adds approximately 0.6 litres of water before use.
- The 'flush' press activates the rinse pump adding a further 0.6litres of water to the bowl and then operates the flush pump, discharging the contents and leaving the bowl dry.

The fill and flush functions operate in a flush cycle sequentially. You need to press the fill button before the flush function operates. You may decide to leave the bowl dry or, by pressing the fill button once more, leave the bowl wet, ready for the next user.

Note: The correct use of the toilet is to:

- Press the 'fill' button
- Use the toilet
- Press the 'flush' button to add water
- And then Discharge

APPLICATIONS

You may install jabsco lite flush electrically operated marine toilets in both power and sailing craft, either above or below the waterline, for use on sea, river, lake or canal.

CAUTION:



JABSCO electric toilets are designed specifically for marine use. Consult ITT for advice about possible non-marine applications.

Your installation may discharge the waste either overboard (provided that your national and local regulations allow this), or into a treatment system or into an on-board holding tank (u.s.c.g. marine sanitation devices type i, ii and iii).

DIMENSIONS - mm (inches)

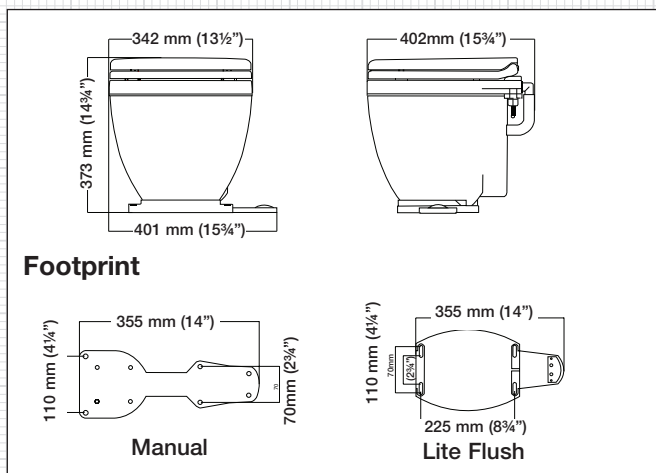

SPECIFICATIONS

Flush pump

- Internally mounted, high speed, non-clogging, centrifugal, waste macerating pump driven by powerful 240 watt, 12 or 24 Vdc, permanent magnet motor with ball bearings and robust ceramic seal, discharges up to 5ft (1.5m) above the base of the toilet.

Rinse pump

- Jabsco, self-priming up to 3m (10ft), dry running, diaphragm water pump driven by 12 or 24 Vdc, permanent magnet, ball bearing motor.

Foot-switch

- Integral one touch 'Press and Release' switch pad, sealed for life.

Control Panel

- One Touch 'Press and Release' switch pad, sealed for life, with 10ft (3m) link cable, fitted quick connector, and heat shrink seal.

Standards

- Complies with ISO8846 MARINE [Ignition protection].



Ports

- Raw Water Rinse pump inlet - 3/4" (19mm) hose tails.
- Flush pump discharge - 1 1/2" (38mm) hose tail.

INSTALLATION INSTRUCTIONS

YOUR TOILET is just one part of a system. Correct installation of the whole system is essential if you want the toilet to perform properly, operate reliably and safely, and give satisfactory length of life.

- The Lite Flush Toilet Foot switch and discharge hose positions may be adapted to replace either a left hand or right hand manual toilet.
- The seat and lid are delivered boxed and unfitted for their protection.
- Key numbers eg. (key 31) are references to the exploded diagram on the back page.

Location

- Select a location that will give sufficient clearance all round and above the bowl.
- The mounting surface must be flat, rigid and strong enough to support a man's weight and should be at least 2" (50mm) wider and 2" (50mm) deeper than the base of the toilet.
- You will need sufficient clearance below the mounting surface to be able to secure the mounting bolts, and to be able to remove them for maintenance.

Mounting

YOU WILL need:

- 4 stainless steel bolts of length to suit the thickness of the mounting surface.
- 4 stainless steel nuts, preferably self-locking. If you do not use self-locking nuts you will need some nut-locking compound.
- Offer up the toilet in the selected position and, using the holes in the base as a guide, mark the positions for the 4 bolt holes on the mounting surface.

Now complete all of the rest of the installation before you secure the bowl.

Through Hull Fittings

YOU MAY need:

- 3/4" (19mm) x 3/4" (19mm) elbow with hose tails for the rinse inlet
- 3/4" (19mm) bore seacock for the Rinse pump and, if you are discharging the waste overboard, a 1 1/2" (38mm) bore seacock for the waste outlet.
- Follow the seacock manufacturer's own instructions concerning materials and methods of installation.
- Ensure the inlet seacock is positioned where it will be below the waterline at all times when the craft is underway, and also ensure that any other outlet seacock is both aft of, and higher than, the inlet seacock.

WARNING:



**HAZARD RISK: Flooding.
FOLLOW THESE INSTRUCTIONS!**

If the installation of the toilet results in it being connected to ANY through-hull fitting that may possibly be below the waterline at ANY time, whether when the craft is at rest, underway and heeling or rolling or pitching, you must install the toilet in accordance with these Installation Instructions. If you do not, water may flood in, causing the craft to sink, which may result in loss of life.

WARNING:



**HAZARD RISK: Accidental Damage.
USE SEACOCKS!**

If the toilet is connected to ANY through-hull fittings and if the toilet or pipework is damaged, water may flood in causing the craft to sink, which may result in loss of life. Therefore, if you are making connections between the toilet and ANY through-hull fittings that may possibly be below the waterline at ANY time, full bore seacocks must be fitted to those hull fittings, to allow them to be shut off.

The seacocks MUST also be positioned where they are easily accessible to all users of the toilet. If, for any reason, it is not possible to do this, then secondary bore marine quality valves MUST be fitted to the hoses where they are easily accessible.

CAUTION:



Use lever operated, full bore marine seacocks and valves. The use of screw-down gate valves is not recommended.

Pipework - selection of correct method

YOU MUST select the correct method for the inlet pipework from 2 options and for the outlet pipework from 4 options, according to whether the toilet is above or below the waterline, and to whether it discharges the waste overboard or into an on-board holding tank.

WARNING:



**HAZARD RISK: Flooding.
USE VENTED LOOPS!**

If the toilet is connected to ANY through-hull fittings, and if the rim of the bowl falls below the waterline, water may flood in causing the craft to sink, which may result in loss of life.

Therefore, if the rim of the toilet is less than 8" (20cm) above the waterline when the craft is at rest, or if there is ANY possibility that the rim of the bowl may be below the waterline at ANY time, a ventilated anti-syphon loop MUST be fitted in any pipework connected to a through-hull fitting, irrespective of whether inlet or outlet.

SPECIAL NOTE 1: The smaller bore inlet pipework is more hazardous than the larger outlet pipework. Unless there is a ventilated anti-syphon loop in the inlet pipework, water will flow into the bowl whenever both the inlet seacock is open and the rim of the bowl is below the actual waterline.

SPECIAL NOTE 2: Making a loop in the hose without fitting a vent may be just as hazardous as no loop at all, because water may syphon over a loop. It is the vent that actually prevents the syphon.

WARNING:



**HAZARD RISK: Pipework Becomes Loose.
USE HOSE CLIPS!**

If the toilet is connected to ANY through-hull fittings and if the pipework becomes disconnected, either from a through-hull fitting or seacock, or from the toilet or any secondary valve, water may flood in and cause the craft to sink, which may result in loss of life.

Therefore the ends of ALL flexible hoses fitted directly or indirectly between the toilet and ANY through-hull fitting that may possibly be below the waterline at ANY time, MUST be secured to the hose tails to which they are connected, using two stainless steel worm-drive hose clips.

Pipework - General instructions for all options

YOU WILL need:

- *Two stainless steel worm-drive hose clips for every hose tail connection.*
- Please ensure the pump guard strainer is fitted to protect the rinse pump. the strainer should be fitted in an accessible position for servicing/cleaning.
- Secure the hose runs so that the hoses cannot move and chafe, and so that they do not exert any leverage on the hose tail fittings to which they are connected, as this may cause adjacent joints to leak.
- Spiral reinforced smooth bore flexible hoses for both the 3/4" (19mm) inlet and the 1 1/2" (38mm) outlet pipework.
- Avoid sharp bends in the hoses as this may cause them to become kinked.
- Keep all pipework runs as straight and as short as possible, avoiding rising and falling over obstructions which creates airlocks.
- If it is difficult to fit the hose onto the hose tails of the toilet or seacocks, lubricate it with water, or soften the hose by dipping the end in hot water.
- Secure the ends of all hoses to the hose tails with two stainless steel worm-drive hose clips, ensuring that all inlet connections are airtight, and that all the outlet connections are water tight.

CAUTION: Do not apply flame to the hose. Do not apply flame or heat to the plastic hose tails on the toilet, rinse pump or solenoid valve. Do not use oils, greases or synthetic lubricants. Do not apply sealing compounds to any hose connections. Do not over tighten hose clips. Any of these actions may result in cracking or breakage of the plastic parts.



Raw Water Rinse Pipework - 2 Options

Option 1: Toilet below the heeled waterline

YOU MUST fit a 3/4" (19mm) Vented Loop fitting, Jabsco part number 29015-0000.

- Run 3/4" (19mm) hose by the most direct route from the inlet seacock to the inlet of the Pumpguard™ (key 34).

CAUTION: Do not position the ventilated anti-syphon loop between the inlet seacock and the rinse pump, because it may prevent the rinse pump from priming.



- Arrange a length of 3/4" (19mm) hose between the Pump outlet and the Rinse Intake Elbow (key 3), to form an anti-syphon loop whose highest point is at least 20cm (8") above the highest possible waterline, and fit the 3/4" (19mm) Vented Loop at the highest point.

Option 2: Toilet always above the heeled waterline

- Run 3/4" (19mm) hose by the most direct route from the inlet seacock to the inlet of the Pumpguard™ (key 34).
- Run 3/4" (19mm) hose by the most direct route from the outlet of the Pumpguard to the Rinse Intake Elbow.

Discharge Pipework - 4 options

Option 1: Toilet below the waterline and discharging overboard.

YOU MUST fit a 1 1/2" (38mm) Vented Loop fitting, Jabsco part number 29015-0010.

- Run 1 1/2" (38mm) outlet hose from the non-return valve (key 20) to form a loop which is at least 8" (20cm) above the highest possible water line, and fit the 1 1/2" (38mm) Vented Loop at the highest point.

Option 2: Toilet always above the heeled waterline and discharging overboard.

- Run 1 1/2" (38mm) outlet hose from the non-return valve down to the outlet seacock by the most direct route.

Option 3: Toilet discharging into holding tank AND top of holding tank above non-return valve at any time.

YOU MUST FIT a 1 1/2" (38mm) Vented Loop fitting, Jabsco part number 29015-0010.

- If there is ANY possibility that the discharge non-return valve may be below the top of the tank at ANY time, a ventilated anti-syphon loop must be fitted in the outlet pipework to ensure that the contents of the tank do not syphon out through the bowl.
- Arrange the outlet hose to form a loop which is at least 8" (20cm) above the highest possible level that the top of the tank may reach, and fit the Vented Loop at that highest point.

Option 4: Toilet discharging into holding tank, AND non-return valve always above the top of holding tank.

- Run the outlet hose by the most direct route from the non-return valve down to the holding tank inlet.

CONTROLS AND ELECTRICS

WARNING: HAZARD WARNING: Flooding FIT ISOLATION SWITCH IN POWER SUPPLY!



The toilet should be switched off at all times when not in use. Please ensure an electrical isolation switch is fitted in the power supply to the toilet. If you do not and an electrical fault occurs with the controller or rinse pump, water may flood in causing the craft to sink, which may result in the loss of life.

YOU MUST:

- Connect the toilet power supply to a primary distribution board with sufficient spare amperage capacity.
- Keep the total length of both the positive and negative wires to a minimum, selecting your wire size from the Electrical Specifications table below.

CAUTION: Inadequate wire size will result in voltage drop, and will reduce performance.



- Make all joints with appropriately rated marine grade terminal blocks and crimp connectors.
- Use marine grade multi-strand copper wire.
- Support all wires approximately every 18" (45cm) with plastic cable clips.

CAUTION: YOU MUST FIT the correct size of fuseholder or circuit breaker, selected from the Electrical Specifications table.



Control Panel

CAUTION:



Remove fuse, or turn circuit breaker off, whilst installing Controls and Electrics.

- Select a position for the Control Panel (key 31) that is convenient for both standing and seated users, and which allows you to run the 10ft (3m) control cable to the toilet.
- To use the JabSCO Fascia Panel provided, (key 32) drill a 5/8" (16mm) hole for the 6 way control cable connector. Screw the control panel (key 31) onto selected location with suitable counter sunk head screws. Clip on fascia panel (key 32).
- To use Gewiss fascia panels remove the four screws tabs (see picture below). Cut a rectangular hole 53mm x 92mm. Fix panel (key 31) to selected location with four counter sunk head screws. Clip on Gewiss fascia panel.
- To use Vimar fascia panels remove the four screw tabs (see picture below) Cut a rectangular hole 53mm x 92mm. Place adaptor (key 33) onto panel (key 31) and screw into place with four counter sunk head screw. Clip on Vimar panel onto adaptor.
- Slide the Heat Shrink Sleeve (key 30) over the control cable. Plug in the 6 way control cable to the toilet, and carefully use a hot air gun or hairdryer to seal the Heat Shrink Sleeve over the 6 way connector.
- Note that the toilet has 2 other leads - Red and Black. Connect your boat's Positive (+) feed to the Red (+) lead, and your boat's Negative (-) return to the Black (-) lead.

Foot-switch

- Connect your boat's Positive (+) feed to the Red (+) lead, and your boat's Negative (-) return to the Black (-) lead.

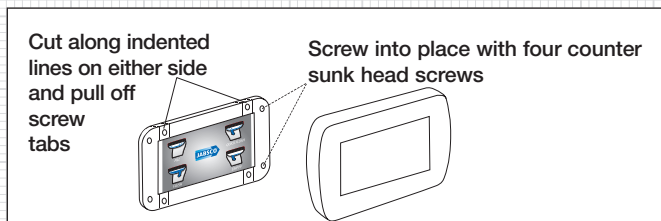

CAUTION:



Do not put anything in the toilet unless you have eaten it first, except toilet paper.

Securing the toilet

- Bolt down the base toilet ensuring that the Foot-switch (key 24) and/or the blank (key 28) are located correctly. Make sure that the cable from the Foot-switch is located in the guide and not trapped.
- With control panel fit 2 blanks, with Foot-switch fit 1 blank on respective side.
- Before fitting the seat and lid, if required, you may rotate the upper part of the toilet and offset the angle of the seat to the base.
- To rotate the top, loosen the two screws in the clamp (key 4) and rotate to the desired position, retighten clamp screws.
- The top may be rotated 68° each side but, you will need to fit a longer 19mm (3/4") inside diameter rinse inlet pipe (key 15).

Testing

- Ensure that the battery is fully charged, and that the circuits are live.
- Open both seacocks.
- Refer to the next section - OPERATING INSTRUCTIONS.
- To prime the Rinse pump on first installation, operate the 'Quick Flush' function (for the control Panel version several times until water flows into the toilet bowl. The foot-switch may have to be pressed several times until water flows into the bowl.

Safety

Ensure that this INSTRUCTION MANUAL reaches the owner, skipper or operator of the craft as it contains essential safety information.

ON COMPLETION - CLOSE BOTH SEACOCKS

OPERATING INSTRUCTIONS

The toilet is one of the most used pieces of equipment on your boat. Correct operation of the toilet is essential for the safety and comfort of your crew and craft.

- Open inlet and outlet seacock (and secondary valves if fitted).
- Use good quality hard or soft household toilet paper, but do not use more than necessary.

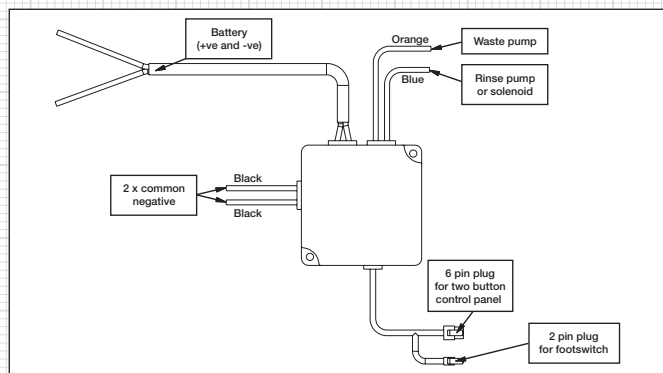

ELECTRICAL SPECIFICATIONS						
Voltage	Amp Draw	Fuse/Breaker	Wire size mm ² (AWG) per metre (foot) of length*			
			0-4 m (0-13 ft)	4-6 m (13-20 ft)	6-12 m (20-40 ft)	12-18 m (40-60 ft)
12 Vdc	20	25 amp	4 mm ² (#10)	6 mm ² (#8)	8 mm ² (#6)	19 mm ² (#4)
24 Vdc	10	15 amp	2.5 mm ² (#16)	4 mm ² (#14)	6 mm ² (#10)	8 mm ² (#10)

* Wire length is the total distance from the battery to the flush pump and back to the battery

WARNING:



HAZARD WARNING:
Contact with moving part

The toilet flush pump incorporates a high speed macerating impeller located directly below the bowl discharge. There is a risk of serious injury should any person put their hand/ fingers in the bowl discharge - please ensure that an electrical isolator is fitted to the toilet and the toilet power supply is isolated at all times when not in use or the toilet is being serviced.

WARNING:



HAZARD RISK: Accidental Damage.
SHUT SEACOCKS!

If the toilet is connected to ANY through-hull fittings that are below the waterline at any time, and if the toilet or pipework is damaged, water may flood in, causing the craft to sink, which may result in loss of life. Therefore after every usage, both seacocks (or secondary valves) MUST be shut.

Whenever your craft is unattended, even if for only a short period of time, both seacocks (even if secondary valves are fitted) MUST be shut.

- Ensure that ALL users understand how to operate the toilet systems correctly and safely, including seacocks and secondary valves.
- Take special care to instruct children and visitors.

Cleaning

- To clean the ceramic bowl, use any liquid or cream ceramic cleaner.

CAUTION:



Do NOT use aggressive chemical agents such as Acetone or Bleach because the plastic parts may crack.

- To clean the rest of the toilet, including the seat and lid, use a non-abrasive liquid cleaner. Polish with a dry cloth only.

CAUTION:



Do not use abrasive pads on any part of the toilet and do not use cream cleaners except for the ceramic bowl.

- To disinfect the toilet, use a liquid disinfectant diluted in accordance with the manufacturers instructions. You may apply it to all parts of the toilet using a sponge or soft brush as necessary.

CAUTION:



Do not use thick liquid toilet cleaners or neat bleach. They may damage the valves, gaskets and seals.

SERVICING INSTRUCTIONS

Jabsco Lite Flush electric toilets do not normally require maintenance during the season, provided that they are winterised in the autumn.

- Regularly check all fastenings for tightness and leaks.

WARNING:



HAZARD RISK: Leaks.
REPAIR LEAKS IMMEDIATELY!

If the toilet is connected to ANY through-hull fittings and, if the toilet or the pipework develops a minor leak, it can suddenly become a major leak that allows water to flood in, causing the craft to sink, which may result in loss of life. Therefore, if ANY leak develops you must repair it immediately.

Rinse pump

- Please refer to the Data Sheet provided for the 31331-Series Rinse pump.

Flush Pump Unit

- The flush pump unit is a non-serviceable item. If leakage or breakdown occurs, please contact your local agent for a replacement unit.

Electrical connections

- Carefully inspect all electrical connections, even if they are protected. Remove any corrosion on the terminals or in the cables, and remake any loose or weak connections, because these cause voltage drop when under load, which directly reduces both Rinse and Flush pump performance. Protect all electrical connections against moisture.

Servicing & Winterisation - preparation

Jabsco Lite Flush electric toilets are designed to be user serviceable and no special skills are required.

- Flush the toilet in accordance with the OPERATING INSTRUCTIONS and ensure that all waste has left the discharge pipework and that the bowl is empty.
- CLOSE BOTH SEACOCKS (even if secondary valves are fitted).
- SWITCH OFF POWER OR REMOVE FUSE.
- Be ready to mop up any water that may come out of the system.

CAUTION:



Do not put antifreeze in the toilet as this may damage the seals.

Servicing - Winterisation

Drain the complete system, both as protection against frost damage and to discourage the growth in the pipework of bacteria that cause unpleasant smells.

- Before undertaking ANY servicing work ensure inlet and outlet seacocks are SHUT and the electrical supply is ISOLATED OFF.
- Loosen hose clips and disconnect the hose ends from both the seacock hose tails. Ensure that all water is drained from the toilet system.

WARNING:	
HAZARD RISK: Flooding ATTACH WARNING NOTICE!	

If you leave the toilet disassembled and, if the seacocks are opened when the craft is afloat, water will flood in and may cause the craft to sink, which may result in the loss of life. Therefore, you **MUST** attach a warning notice to the seacocks and, if possible wire the seacocks shut.

If you are not leaving the toilet disassembled:

- Reconnect all hose ends and secure them with their hose clips.
- Replace the non-return valve assembly.
- Fasten down the seat and lid to prevent use and attach a warning notice.

To Disassemble:

- Remove seat and lid.
- Release upper unit clamp (key 4) by removing the 2 securing screws.
- Remove pipe (key 15) connected to elbow (key 3).
- Remove connecting pipes (key 18).
- Rotate and lift the top (key 2) until it releases from the outer housing (key 35).
- The rinse pump is removed by releasing the retaining screw in the pump base (key 9).

Note: the pump is removed complete with the inlet and outlet elbows.

- Rotate the discharge elbow (key 14) until the retaining clip is pointing upwards and remove clip. Pull the elbow from the exterior to release it from the pump housing.
- To remove the flush pump release the 4 retaining screws (key 13).

REASSEMBLE IN REVERSE ORDER – NOTE!

- Ensure flush pump vibration washers (key 13) are correctly located.
- Apply a light smear of white lubricating grease to the interior of the bowl seal (key 11).
- Do not over tighten any mounting screws.

SERVICING AND TESTING

Hoses

- Examine all hoses throughout their length for chafe, kinks and splits under hose clips. Check all hose clips for corrosion and replace worn or damaged parts.

CAUTION:	
Do not apply flame to the hose. Do not apply flame or heat to the plastic hose tails on the toilet, rinse pump or solenoid valve. Do not use oils, greases or synthetic lubricants. Do not apply sealing compounds to any hose connections. Do not over tighten hose clips. Any of these actions may result in cracking or breakage of the plastic parts.	

- Reconnect all hoses and secure them with their hose clips.
- Reconnect power supply and open seacocks.
- Test unit and inspect for leaks.

TROUBLE SHOOTING

Bowl fills when not in use

- Shut seacock.
- Fit Vented Loops.

Waste water re-appears in bowl

- Check non-return valve (key 20).

Bowl does not empty

- Is Flush pump running?
- Open Outlet Seacock.
- Check non-return valve assembly (key 20), Discharge Hose or Outlet Seacock for blockage (you may need to remove the flush pump for cleaning. Follow disassembly instructions to remove the pump. Clean, check impeller and reassemble).
- Check 'fill' button on control panel has been pressed.

Water does not come in

- Is Rinse pump running?
- Open Inlet seacock.
- Check Inlet hose connections are airtight.
- Is water present in the bowl? If so press flush to complete the cycle.

Toilet does not function

- Is toilet broken?
- Has the fuse or circuit breaker tripped?
- If toilet is blocked (flush pump), this may cause the fuse or breaker to trip (see instructions above).

Spare Parts

Service Kits Available		
Kit	Description	Part No.
A	Hose Kit	58550-1000
B	Pump Assembly Kit 12v	58540-1012
	Pump Assembly Kit 24v	58540-1024
C	Control Kit (Footswitch)	58555-1000
D	Control Kit (Panel)	58552-1000
E	Pulley and Belt Kit*	58541-1000

*Contains Small and Large Pulley, Belt and clip.

Key	Description	Qty.	Part Number	A	B	C	D
1	Seat and Lid	1	58530-1000B				
2	Top	1					
3	Intake Elbow and Clip	1					
4	Seat and Lid Clamp Kit	1					
5	Top Bowl Seal	1	58514-1000				
6	Ceramic Bowl	1					
7	Clamp Ring	1					
8	Control Box (Footswitch)	1	see kits			1	
9	Rinse Pump 12v	1	31331-0092				
	Rinse Pump 24v	1	31331-0094				
10	Rinse Pump Bracket	1					
11	Bowl Outlet Seal	1	see kits		1		
12	Pump Assembly 12v	1	see kits		1		
	Pump Assembly 24v	1	see kits		1		
13	Pump Assy Fixings	4	see kits		1		
14	Discharge Elbow and Clip	1	see kits		1		
15	Inlet Hose	1	see kits	1			
16	Small Hose Clip	2					
17	Medium Hose Clip	1					
18	Outlet Hose	1	see kits	1			
19	Large Hose Clip	1					
20	Non Return Valve Assembly	1	58109-1000				
21	Joker Valve	1	29092-1000				
22	Screw, Footswitch	2					
23	Switch Support	1					
24	Footswitch	1	see kits			1	
25	Switch Mount	1					
26	Screw Covers	4					
27	Base	1					
28	Foot Panel Blank	1	see kits			1	2
29	Control Box	1	see kits				1
30	Heat Shrink Sleeve	1	see kits				1
31	Panel	1	see kits				1
32	Jabsco White Fascia Panel	1	see kits				1
33	Adaptor Plate	1	see kits				1
34	Pumpgard	1	46400-0000				
35	Outer Bowl	1					

Exploded View

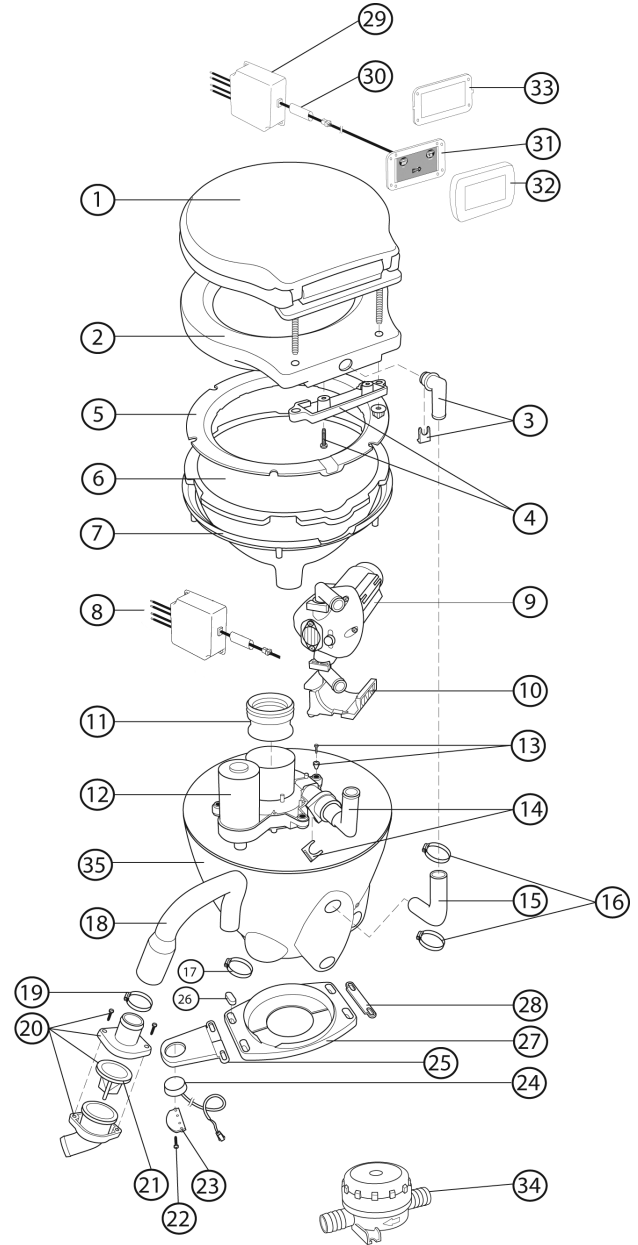

xylem

Let's Solve Water

www.xyleminc.com

UK
Jabsco
Bingley Road, Hoddesdon
Hertfordshire EN11 0BU
Tel: +44 (0) 1992 450145
Fax: +44 (0) 1992 467132

USA
Jabsco
Cape Ann Industrial Park
Gloucester, MA 01930
Tel: (978) 281-0440
Fax: (978) 283-2619

ITALY
Jabsco Marine Italia
Via Tommaseo, 6
20059 Vimercate, Milano
Tel: +39 039 685 2323
Fax: +39 039 666 307

GERMANY
Jabsco GmbH
Oststrasse 28
22844 Norderstedt
Tel: +49-40-53 53 73-0
Fax: +49-40-53 53 73-11

JAPAN
NHK Jabsco Company Ltd.
3-21-10, Shin-Yokohama
Kohoku-Ku, Yokohama, 222-0033
Tel: +81-045-475-8906
Fax: +81-045-477-1162

Warranty: All products of the company are sold, and all services of the company are offered subject to the company's warranty and terms of sale, copies of which will be furnished upon request. Details correct at time of printing. We reserve the right to change specifications without prior notice. Copyright 2011 Xylem Inc. Jabsco is a trademark of Xylem Inc. or one of its subsidiaries.