

Parts Illustrations for Model 9910-D160

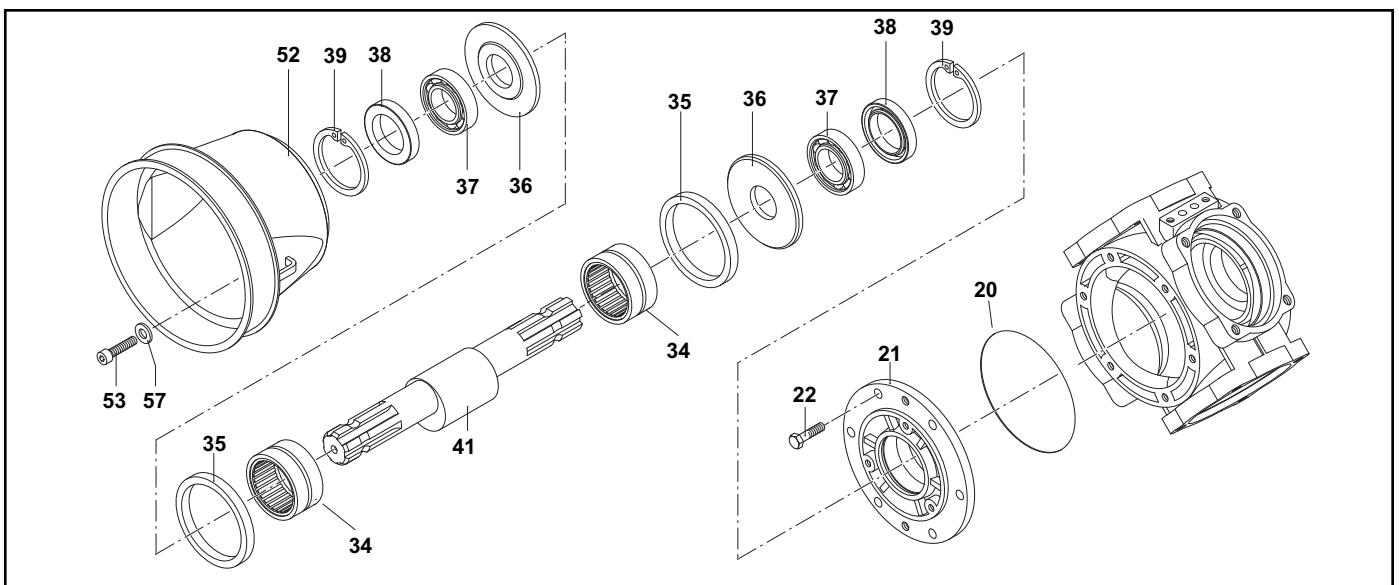
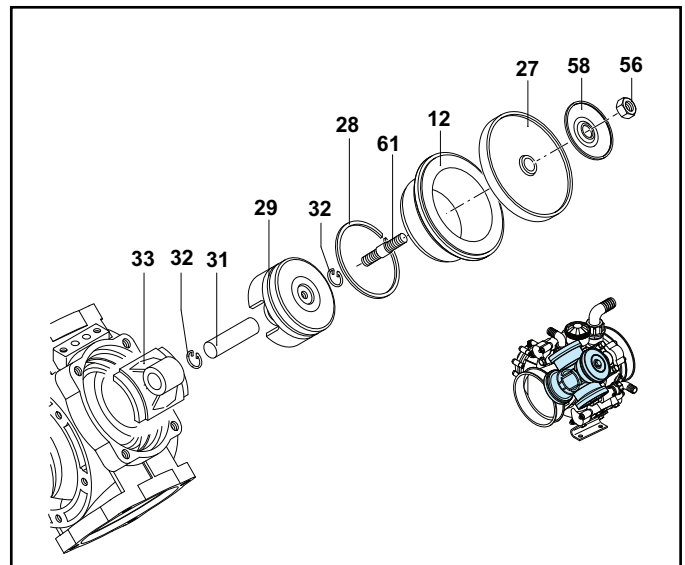
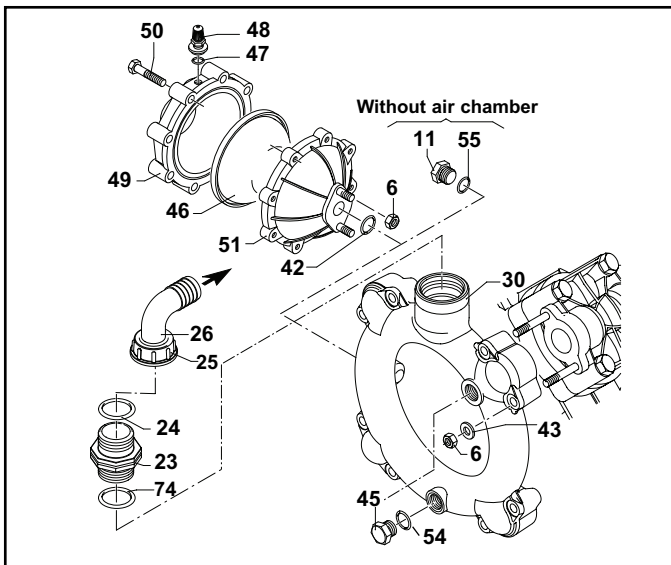
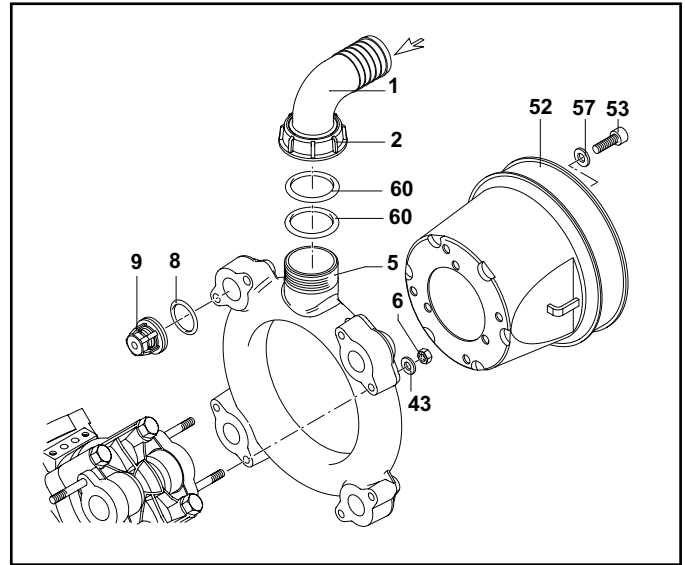
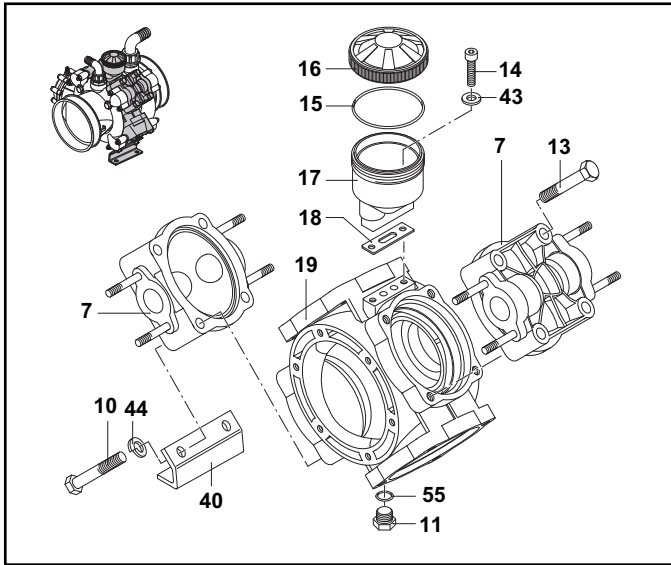

Figure 10. Parts Illustrations for Model 9910-D160

Parts List for Model 9910-D160

REF. NO.	PART NUMBER	DESCRIPTION	QTY. REQ'D
1	9910-3040440	Elbow 2"	1
2	9910-3040450	Ring nut	1
5	9910-760750	Suction manifold	1
6	9910-380242	Nut	18
7	9910-750100	Head	4
8	9910-680070	O-ring	8
9	9910-759051	Complete valve	8
10	9910-750071	Bolt	4
11	2406-0023	Oil drain plug	2
12	9910-750110	Sleeve	4
13	9910-750061	M12 x 65 Bolt	12
14	9910-680350	M8 x 35 Bolt	2
15	9910-1040060	O-ring	1
16	9910-750057	Black oil tank cap	1
17	9910-750030	Oil sight glass	1
18	9910-750040	Gasket	1
19	9910-761010	Pump body	1
20	9910-851360	O-ring	1
21	9910-680020	Bearing support housing	1
22	9910-160672	M10 x 25Bolt	6
23	9910-751130	Threaded adapter	1
24	9910-390290	O-ring	1
25	9910-750670	Ring nut	1
26	9910-3040160	Elbow 1-1/2"	1
27	9910-550085	Diaphragm (Desmopan) Standard	4
27a	9910-550080	Diaphragm (Buna) Optional	4
28	9910-500260	Piston ring	4
29	9910-750122	Piston	4
30	9910-760760	Manifold	1
31	9910-160700	Pin	4
32	9910-160691	Pin ring	8
33	9910-760140	Connecting rod	4
34	9910-750090	Roller bearing	2
35	9910-750130	Connecting rod ring	2
36	9910-540040	Spacer washer	2
37	9910-230350	Bearing	2
38	9910-160740	Seal ring	2
39	9910-200390	Retainer ring	2
40	9910-760201	Base	2
41	9910-750170	Crankshaft	1
42	9910-390290	O-ring	1
43	9910-380243	Washer	18
44	9910-250143	Washer	4
45	9910-330173	Plug	2
46	9910-550190	Accumulator diaphragm	1
47	9910-650542	O-ring	1
48	9910-180020	Air valve	1
49	9910-620232	Accumulator head	1
50	9910-621781	M8 x 40 Bolt	8
51	9910-680180	Accumulator body	1
52	9910-1500350	Shield	2
53	9910-850251	M8 x 12 Bolt	6
54	9910-180101	O-ring	2
55	9910-740290	O-ring	2
56	9910-2240110	Diaphragm nut	4
57	9910-390314	Washer	6
58	9910-751250	Retaining washer	4
59	9910-390670	Accumulator stud	1
60	9910-3040470	O-ring	2
61	9910-2240100	Diaphragm stud	4
74	9910-751140	O-ring	1

Ref. No.	Description	Tightening Torque	
		In. Lbs.	Nm
6	Nut	175	19.8
10	Bolt	440	49.7
11	Plug	175	19.8
13	Bolt	440	49.7
14	Bolt	90	10.2
22	Bolt	310	35.0
45	Plug	350	39.2
50	Bolt	175	19.8
53	Bolt	90	10.2
56	Diaphragm Nut	265	29.9



9910-KIT1730 Diaphragm Kit Desmopan	
REF. NO.	QTY.
8	8
27	4
46	1



9910-KIT2374 Valve Kit	
REF. NO.	QTY.
8	8
9	8



9910-KIT1908 O-Ring Kit	
REF. NO.	QTY.
8	8
15	1
24	1
42	2
47	1
54	2
55	2

NOTE: When ordering parts, give QUANTITY, PART NUMBER, DESCRIPTION, and COMPLETE PUMP MODEL NUMBER. Reference numbers are used ONLY to identify parts in the drawing and are NOT to be used as order numbers.