



HS

60 HZ STANDARD CAPACITY 4" SUBMERSIBLE PUMPS



FEATURES

- Powered by Goolds Water Technology 4" motors for dependable operation and long service life.
- Built-in check valve screws into discharge head from the top, easily removed for drain-back systems or replacement without disassembling the pump. Spring loaded, o-ring poppet design for positive seal in all conditions.
- Nylon motor adapter for strength and corrosion resistance.
- Stainless steel hex design shafts, shaft couplings, casings and stage bowls inhibit corrosion.
- Glass filled engineered composite impellers for abrasion resistance and durability.
- Glass filled engineered composite diffusers are abrasion resistant.

- All engineered composite components are non-toxic, non-leaching, FDA compliant materials.
- Goolds Water Technology field proven floating impeller stack design for superior sand and abrasive handling and durability.
- **Quad Lock Technology:** 4 Roll Formed grooves provide durability and strength, tested to exceed strength of poly and PVC pipes.
- Complete pump/motor assemblies are CSA listed, CSA/CUS approved motors are available in 2-wire and 3-wire single phase designs.



- Maximum allowable pressure - 300 psi

NOMENCLATURE

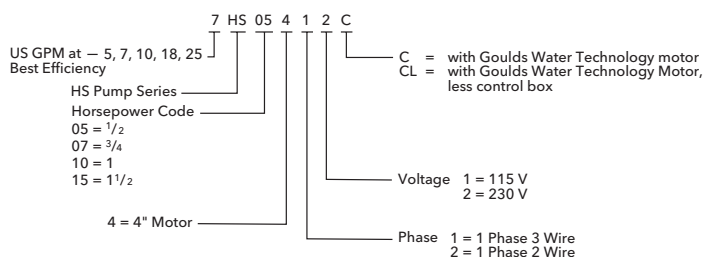

WATER END DATA

Model	Order No.	Req. HP	Stages	Weight (lbs)	Length (in)
5HS	5HS05	1/2	12	5.5	15.7
	5HS07	3/4	15	6.5	17.8
	5HS10	1	20	8.1	21.2
7HS	7HS05	1/2	10	4.9	14.6
	7HS07	3/4	13	5.9	16.7
	7HS10	1	17	7.2	19.6
10HS	10HS05*	1/2	10	13.6	12.3
	10HS07*	3/4	14	16.4	14.4
	10HS10*	1	16	17.7	15.7
	10HS15	1 1/2	17	18.4	19.2
18HS	18HS07	3/4	6	3.8	12.6
	18HS10	1	8	4.5	14.3
	18HS15	1 1/2	11	5.6	16.8
25HS	25HS10	1	7	4.3	14.0
	25HS15	1 1/2	9	5.1	15.9

* New High Head Hydraulic Design for models manufactured starting 8/2017

MATERIALS OF CONSTRUCTION

Part Name	Material
Discharge Head	Glass Filled Engineered Composite
Check Valve Poppet	Delrin®
Check Valve Seal	BUNA, FDA compliant
Check Valve Retaining Ring	AISI 302 SS
Bearing	Proprietary Engineered Polymer
Shaft Retaining Ring	AISI 301 SS
Diffuser	Glass Filled Engineered Composite
Impeller	Glass Filled Engineered Composite
Bowl	AISI 304 SS
Shim	AISI 304 SS
Screws - Cable Guard	AISI 304 SS
Motor Adapter	Glass Filled Engineered Composite
Casing	AISI 304 SS
Shaft	AISI 304 SS
Coupling	AISI 304 SS, Powder Metal
Cable Guard	AISI 304 SS

Optional wrap around suction strainer

Order 7K3356 (quantity 1) • Order 7K3361 (quantity 50)

2-WIRE MODELS WITH GOOLDS WATER TECHNOLOGY MOTOR

Model	Order No.	HP	Stages	Volts	2-Wire CP
5HS	5HS05421C	½	12	115	M05421
	5HS05422C	½	12	230	M05422
	5HS07422C	¾	15	230	M07422
	5HS10422C	1	20	230	M10422
7HS	7HS05421C	½	10	115	M05421
	7HS05422C	½	10	230	M05422
	7HS07422C	¾	13	230	M07422
	7HS10422C	1	17	230	M10422
10HS	10HS05421C*	½	10	115	M05421
	10HS05422C*	½	10	230	M05422
	10HS07422C*	¾	14	230	M07422
	10HS10422C*	1	16	230	M10422
	10HS15422C	1½	17	230	M15422
18HS	18HS07422C	¾	6	230	M07422
	18HS10422C	1	8	230	M10422
	18HS15422C	1½	11	230	M15422
25HS	25HS10422C	1	7	230	M10422
	25HS15422C	1½	9	230	M15422

3-WIRE MODELS WITH GOOLDS WATER TECHNOLOGY MOTOR

Model	Order No.	HP	Stages	Volts	3-Wire CP
5HS	5HS05411C	½	12	115	M05411
	5HS05412C	½	12	230	M05412
	5HS07412C	¾	15	230	M07412
	5HS10412C	1	20	230	M10412
7HS	7HS05411C	½	10	115	M05411
	7HS05412C	½	10	230	M05412
	7HS07412C	¾	13	230	M07412
	7HS10412C	1	17	230	M10412
10HS	10HS05411C*	½	10	115	M05411
	10HS05412C*	½	10	230	M05412
	10HS07412C*	¾	14	230	M07412
	10HS10412C*	1	16	230	M10412
	10HS15412C	1½	17	230	M15412
18HS	18HS07412C	¾	6	230	M07412
	18HS10412C	1	8	230	M10412
	18HS15412C	1½	11	230	M15412
25HS	25HS10412C	1	7	230	M10412
	25HS15412C	1½	9	230	M15412

* New High Head Hydraulic Design for models manufactured starting 8/2017

GENERATION II – 2-WIRE & 3-WIRE WEIGHTS AND DIMENSIONS

Type	Goolds Order No.	HP	Volts	Length (L) In.	Weight (lbs)
2-Wire	M05421	.5	115	10.5	18
	M05422	.5	230	10.5	18
	M07422	.75		11.9	22
	M10422	1		12.5	24
	M15422	1.5		14.2	28
3-wire	M05411	.5	115	9.6	18
	M05412	.5	230	9.2	17
	M07412	.75		10.3	20
	M10412	1		11.2	22
	M15412	1.5		12.8	26
	M20412	2		15.1	31
	M30412	3		18.3	40
	M50412	5		27.7	70

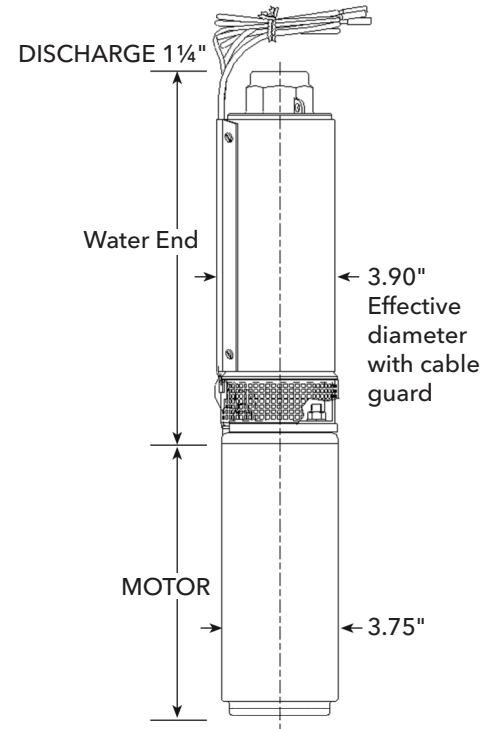

MODEL 5HS

SELECTION CHART

Horsepower Range ½ - 1½, Recommended Range 1.2 - 7.5 gpm, 60 Hz, 3450 rpm

Pump Model	HP	PSI	Depth to Water in Feet/Ratings in GPM (Gallons per Minute)																													
			20	40	60	80	100	120	140	160	180	200	220	240	260	280	300	340	380	420	460	500	540	580	620	660	700	740	780	820	860	
5HS05	½	0							7.7	7.3	6.9	6.4	6.0	5.6	5.1	4.7	4.1	2.6														
		20					7.5	7.1	6.7	6.3	5.9	5.4	5.0	4.5	3.9	3.2	2.3															
		30				7.5	7.1	6.7	6.2	5.8	5.4	4.9	4.4	3.8	3.1	2.1																
		40			7.4	7.0	6.6	6.2	5.7	5.3	4.9	4.3	3.7	2.9	1.9																	
		50	7.7	7.4	6.9	6.5	6.1	5.7	5.2	4.8	4.2	3.6	2.8	1.8																		
		60	7.3	6.9	6.5	6.0	5.6	5.2	4.7	4.2	3.5	2.6	1.6																			
Shut-off PSI			156	147	138	130	121	112	104	95	86	78	69	60	52	43	34	17														
5HS07	¾	0											7.6	7.3	7.0	6.6	6.3	5.9	5.2	4.4	3.3	1.6										
		20								7.5	7.2	6.9	6.5	6.2	5.8	5.5	5.1	4.2	3.1	1.3												
		30							7.5	7.2	6.8	6.5	6.1	5.8	5.4	5.0	4.6	3.6	2.1													
		40						7.4	7.1	6.8	6.4	6.1	5.7	5.4	5.0	4.6	4.1	2.8														
		50					7.4	7.1	6.7	6.4	6.0	5.7	5.3	4.9	4.5	4.0	3.4	1.8														
		60			7.6	7.3	7.0	6.7	6.3	6.0	5.6	5.3	4.9	4.4	3.9	3.3	2.6															
Shut-off PSI					184	175	167	158	149	141	132	123	115	106	97	89	80	63	45	28	11											
5HS10	1	0															7.5	7.0	6.5	5.9	5.3	4.6	3.8	2.8	1.6							
		20												7.6	7.4	7.2	7.0	6.4	5.9	5.2	4.5	3.7	2.6									
		30												7.6	7.4	7.2	6.9	6.7	6.1	5.5	4.8	4.0	3.1	1.9								
		40											7.6	7.4	7.1	6.9	6.6	6.3	5.8	5.1	4.4	3.5	2.5									
		50										7.5	7.3	7.1	6.8	6.6	6.3	6.0	5.4	4.7	3.9	2.9	1.7									
		60									7.5	7.3	7.1	6.8	6.5	6.3	6.0	5.7	5.0	4.3	3.4	2.3										
Shut-off PSI										214	206	197	188	180	171	162	154	136	119	102	84	67	50	32	15							

MODEL 7HS

SELECTION CHART

Horsepower Range ½ - 1, Recommended Range 1.5 - 10 gpm, 60 Hz, 3450 rpm

Pump Model	HP	PSI	Depth to Water in Feet/Ratings in GPM (Gallons per Minute)																														
			20	40	60	80	100	120	140	160	180	200	220	240	260	280	300	320	340	360	380	400	420	440	460	480	500	540	580	620			
7HS05	½	0									10.1	9.2	8.3	7.4	6.3	5.0	3.4																
		20							9.8	9.0	8.1	7.1	6.0	4.6	2.7																		
		30					9.7	8.8	7.9	6.9	5.8	4.3	2.4																				
		40			10.4	9.6	8.7	7.8	6.7	5.6	4.1	2.0																					
		50		10.3	9.4	8.5	7.6	6.6	5.4	3.8	1.7																						
		60	10.2	9.3	8.4	7.5	6.4	5.1	3.5																								
Shut-off PSI			125	116	107	99	90	81	73	64	55	47	38	29	21	12																	
7HS07	¾	0												10.0	9.3	8.6	7.9	7.1	6.2	5.2	4.0	2.4											
		20								10.4	9.8	9.1	8.4	7.7	6.9	6.0	4.9	3.5	1.8														
		30								10.3	9.7	9.0	8.3	7.5	6.7	5.8	4.7	3.3	1.5														
		40								10.2	9.5	8.9	8.2	7.4	6.6	5.6	4.5	3.1															
		50					10.1	9.4	8.8	8.1	7.3	6.5	5.5	4.3	2.8																		
		60				10.0	9.3	8.7	7.9	7.2	6.3	5.3	4.1	2.5																			
Shut-off PSI					140	131	122	114	105	96	88	79	70	62	53	44	36	27	18	10													
7HS10	1	0															10.1	9.6	9.0	8.5	7.9	7.3	6.7	6.0	5.3	4.4	3.4	2.1					
		20													10.4	9.9	9.4	8.9	8.3	7.7	7.1	6.5	5.8	5.0	4.1	3.0	1.6						
		30													10.3	9.9	9.3	8.8	8.2	7.6	7.0	6.4	5.7	4.9	4.0	2.8							
		40												10.3	9.8	9.2	8.7	8.1	7.5	6.9	6.3	5.6	4.8	3.8	2.6								
		50										10.2	9.7	9.2	8.6	8.0	7.4	6.8	6.2	5.4	4.6	3.7	2.4										
		60								10.1	9.6	9.1	8.5	7.9	7.3	6.7	6.0	5.3	4.5	3.5	2.2												
Shut-off PSI								166	158	149	140	132	123	114	106	97	88	80	71	62	54	45	36	28	19	10							

MODEL 10HS

SELECTION CHART

Horsepower Range ½ – 1½, Recommended Range 3 – 16 gpm, 60 Hz, 3450 rpm

Pump Model	HP	PSI	Depth to Water in Feet/Ratings in GPM (Gallons per Minute)																								
			20	40	60	80	100	120	140	160	180	200	220	240	260	280	300	320	340	360	380	400	420	440	460		
10HS05*	½	0			15.7	14.9	14.1	13.3	12.4	11.4	10.4	9.3	8.0	6.3	3.9												
		20	15.4	14.7	13.9	13.0	12.1	11.1	10.1	8.9	7.5	5.7	2.9														
		30	14.6	13.8	12.9	12.0	11.0	9.9	8.7	7.3	5.3	2.3															
		40	13.6	12.8	11.8	10.8	9.7	8.5	7.0	4.9	1.7																
		50	12.6	11.7	10.6	9.5	8.3	6.8	4.5	1.0																	
		60	11.5	10.5	9.3	8.1	6.5	4.1	0.2																		
Shut-off PSI			113	105	96	87	79	70	61	53	44	35	27	18	9	1											
10HS07*	¾	0				15.7	15.2	14.6	14.0	13.4	12.7	12.0	11.4	10.8	10.1	9.5	8.7	7.7	6.4	4.6	2.1						
		20	16.0	15.5	15.0	14.5	13.8	13.2	12.5	11.8	11.2	10.6	9.9	9.2	8.4	7.3	5.9	3.9	1.2								
		30	15.5	15.0	14.4	13.7	13.1	12.4	11.7	11.1	10.5	9.8	9.1	8.3	7.1	5.6	3.5	0.7									
		40	14.9	14.3	13.6	12.9	12.3	11.6	11.0	10.4	9.7	9.0	8.1	6.9	5.3	3.1	0.2										
		50	14.2	13.5	12.8	12.2	11.5	10.9	10.3	9.6	8.9	8.0	6.7	5.0	2.7												
		60	13.4	12.7	12.1	11.4	10.8	10.2	9.5	8.7	7.8	6.5	4.7	2.3													
Shut-off PSI			161	152	143	135	126	118	109	100	92	83	74	66	57	48	40	31	22	14	5						
10HS10*	1	0					15.7	15.2	14.8	14.4	14.0	13.6	13.2	12.7	12.1	11.4	10.7	10.0	9.3	8.6	7.9	7.0	5.7	3.8	0.6		
		20		16.0	15.5	15.0	14.6	14.3	13.9	13.5	13.0	12.5	11.9	11.2	10.5	9.8	9.1	8.4	7.6	6.7	5.2	2.9					
		30	16.0	15.4	15.0	14.6	14.2	13.9	13.4	13.0	12.4	11.8	11.1	10.4	9.7	9.0	8.3	7.5	6.5	4.9	2.5						
		40	15.3	14.9	14.5	14.2	13.8	13.4	12.9	12.3	11.6	11.0	10.3	9.6	8.9	8.2	7.4	6.3	4.6	2.0							
		50	14.8	14.5	14.1	13.7	13.3	12.8	12.2	11.5	10.9	10.1	9.5	8.8	8.1	7.2	6.1	4.3	1.5								
		60	14.4	14.1	13.7	13.2	12.7	12.1	11.4	10.7	10.0	9.4	8.7	7.9	7.1	5.8	3.9	0.9									
Shut-off PSI			192	184	175	166	158	149	140	132	123	114	106	97	88	80	71	62	54	45	36	28	19	10	2		

* New High Head Hydraulic Design for models manufactured starting 8/2017

MODEL 18HS

SELECTION CHART

Horsepower Range $\frac{3}{4}$ - $1\frac{1}{2}$, Recommended Range 6 - 28 gpm, 60 Hz, 3450 rpm

Pump Model	HP	PSI	Depth to Water in Feet/Ratings in US GPM (Gallons per Minute)														
			20	40	60	80	100	120	140	160	180	200	220	240	260	280	300
18HS07	$\frac{3}{4}$	0			28.2	26.5	24.0	21.0	17.9	13.5							
		20	27.7	25.9	23.0	20.0	16.5	10.8									
		30	25.0	22.0	18.8	15.7	9.5										
		40	22.2	18.9	15.1	9.0											
		50	18.4	15.0	7.5												
		60	13.5	5.0													
Shut-off PSI			74	66	58	49	40	32	23	14							
18HS10	1	0					27.0	25.5	23.6	21.2	18.8	15.9	12.0				
		20		28.0	26.6	25.1	22.7	20.0	17.6	14.0	10.0						
		30	27.9	26.1	24.3	22.2	19.8	17.1	13.8	8.3							
		40	26.0	24.1	22.0	19.7	17.0	13.1	8.0								
		50	24.0	22.0	19.1	16.5	13.0	7.1									
		60	21.0	18.6	15.8	12.0											
Shut-off PSI			103	94	86	77	68	60	51	42	34	25	16				
18HS15	$1\frac{1}{2}$	0						28.4	27.2	26.0	24.8	23.0	21.4	19.6	17.5	15.0	12.1
		20				27.8	26.8	25.4	24.0	22.2	20.6	18.8	16.7	14.0	10.0		
		30			27.7	26.5	25.3	23.8	22.0	20.2	18.5	16.1	13.5	10.0			
		40		27.5	26.3	25.0	23.6	22.0	20.1	18.1	16.0	13.1	9.5				
		50	27.6	26.4	25.0	23.4	21.8	20.0	18.0	15.5	13.0	9.2					
		60	26.0	24.6	23.0	21.2	19.5	17.5	15.0	12.0	7.9						
Shut-off PSI			143	134	126	117	108	100	91	82	74	65	56	48	39	30	22

MODEL 25HS

SELECTION CHART

Horsepower Range 1, Recommended Range 8 - 33 gpm, 60 Hz, 3450 rpm

Pump Model	HP	PSI	Depth to Water in Feet/Ratings in GPM (Gallons per Minute)												
			20	40	60	80	100	120	140	160	180	200	220	240	260
25HS10	1	0			31.5	29.3	27.2	24.7	22.8	18.9	15.0	10.7			
		20	30.8	29.1	26.7	24.4	21.3	18.4	14.6	7.8					
		30	28.7	26.4	24.3	21.0	17.5	13.6							
		40	26.3	24.2	20.9	17.4	13.5								
		50	23.6	20.4	17.0	12.6									
		60	19.4	15.7	10.7										
Shut-off PSI			80	72	63	54	47	38	29	21	13	4			
25HS15	1½	0				32.0	30.8	29.4	27.9	26.1	24.1	21.3	19.2	16.5	11.0
		20		31.6	30.3	28.7	27.2	25.2	23.1	20.4	17.6	14.4	7.8		
		30	31.5	30.1	28.6	26.8	24.8	22.5	20.3	17.4	13.6				
		40	30.0	28.5	26.7	24.7	22.4	20.2	17.2	13.2					
		50	28.1	26.4	24.3	22.2	19.8	16.7	12.6						
		60	26.1	24.1	21.3	19.2	16.0	10.7							
Shut-off PSI			108	100	91	82	75	66	57	49	41	32	24	16	7

Model 5HS

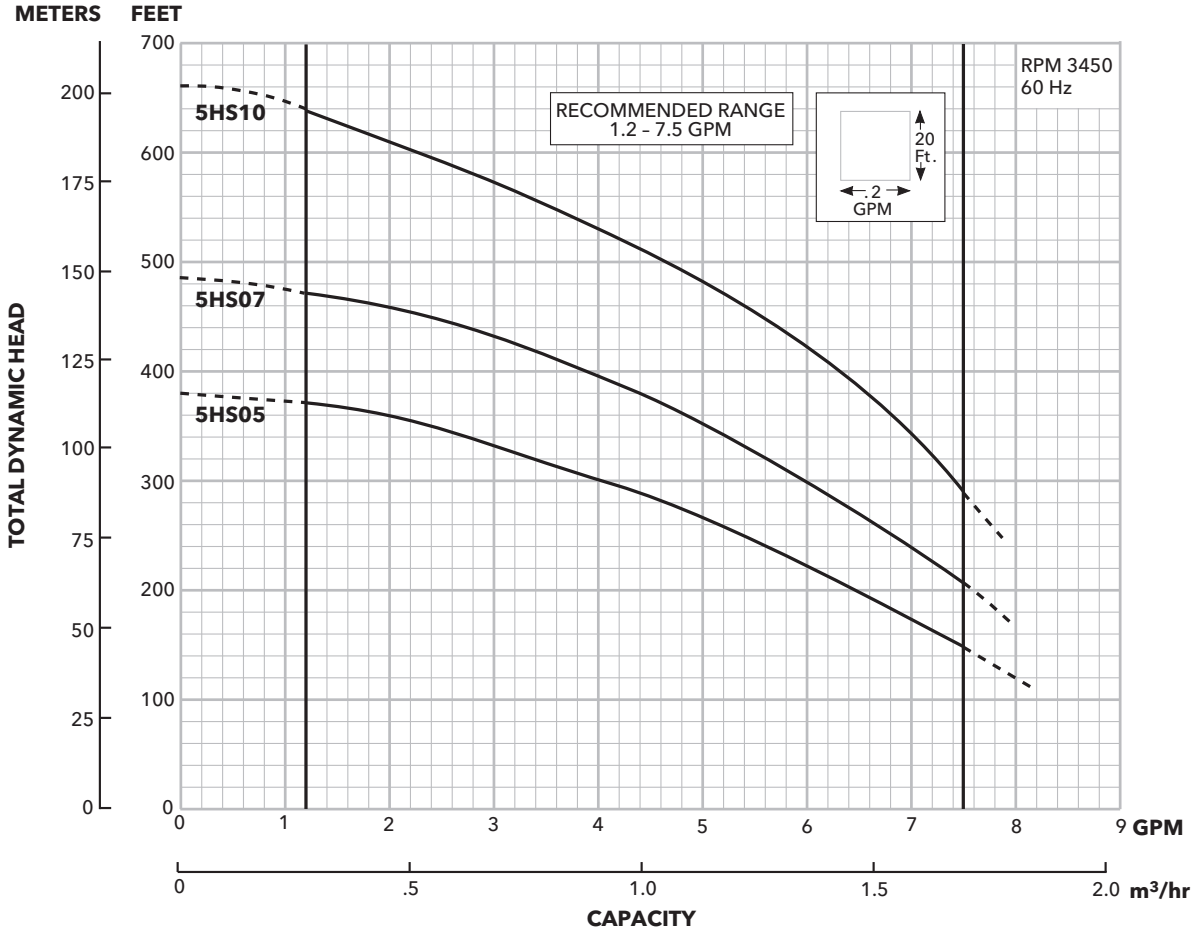

Model 7HS

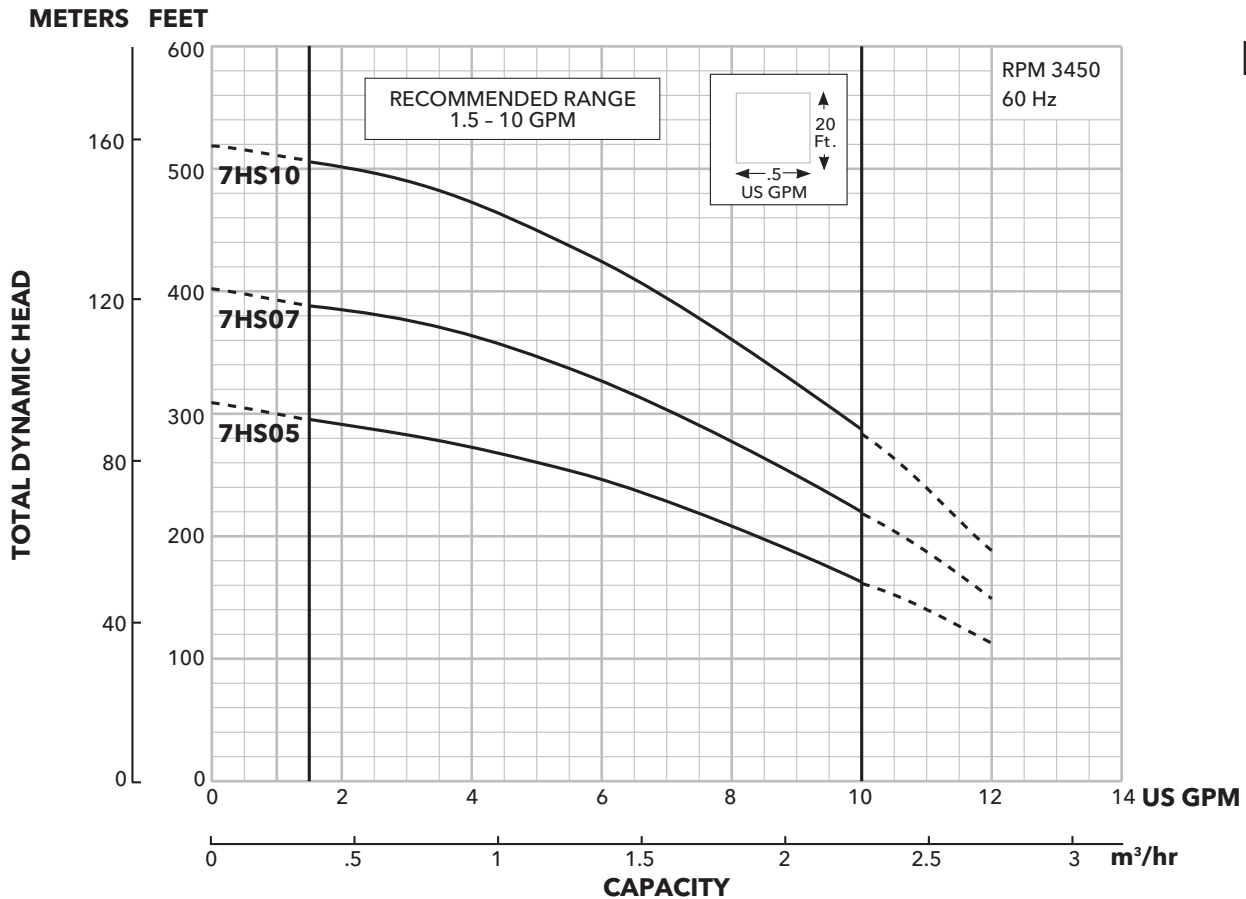

Model 10HS

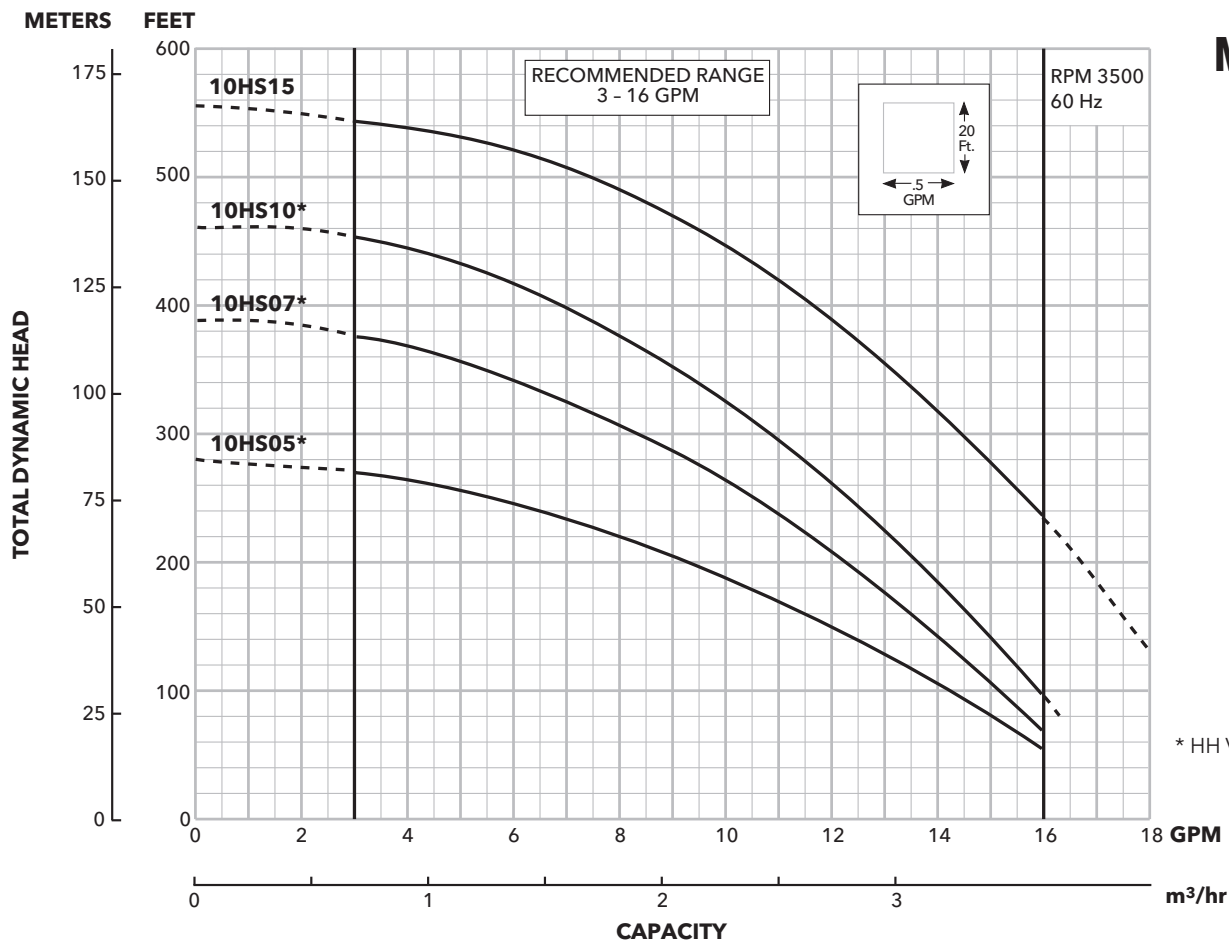

Model 18HS

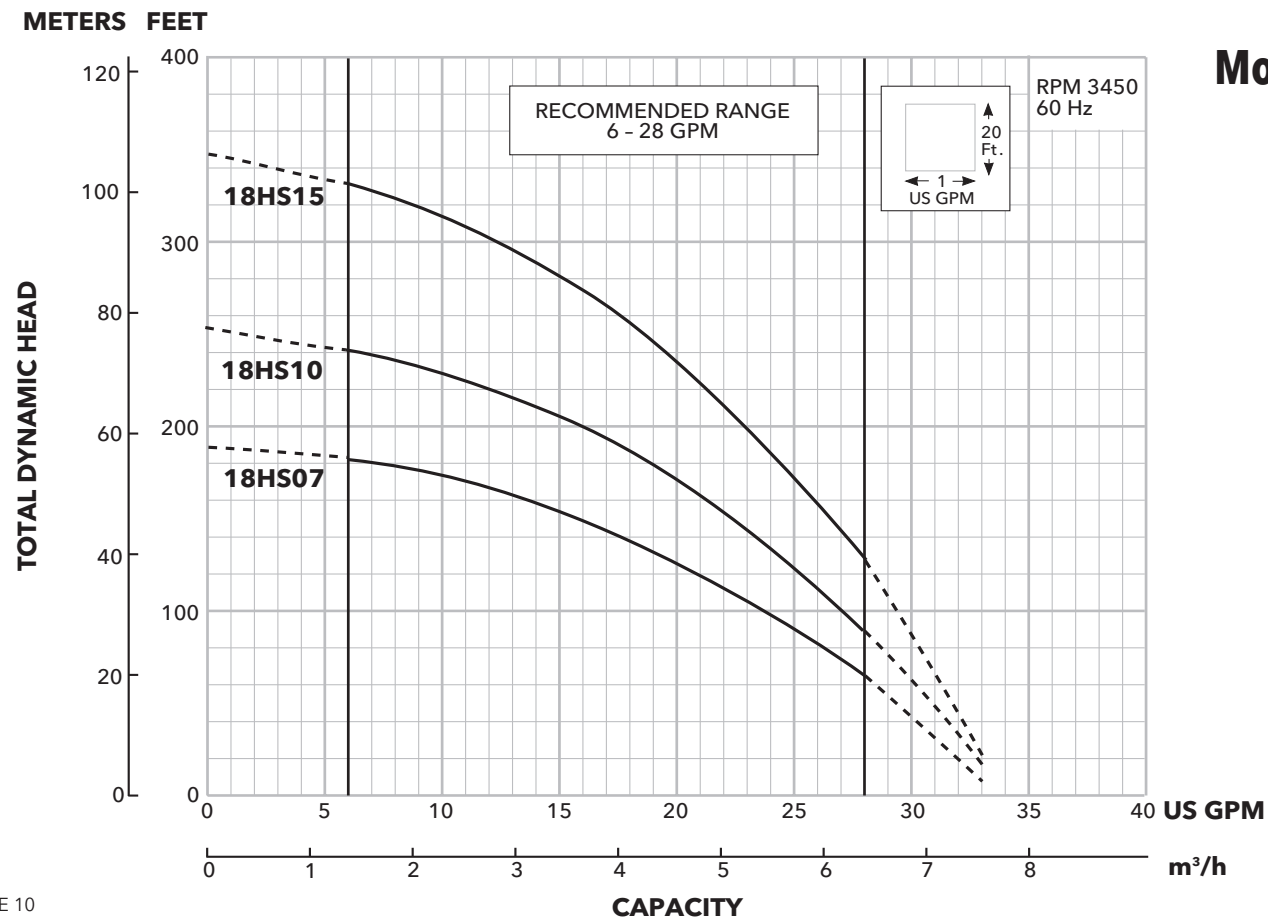

Model 25HS

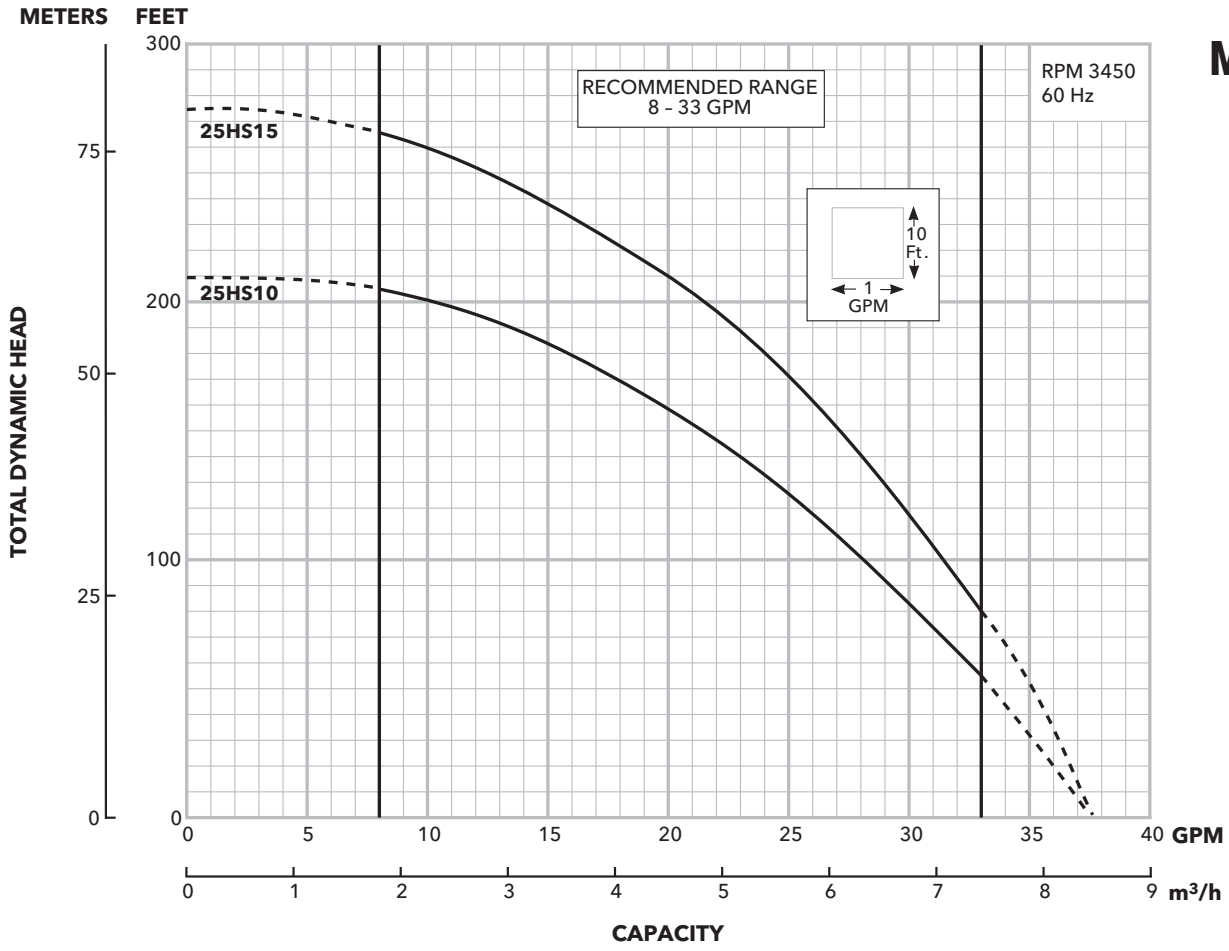

Xylem |'zīləm|

- 1) The tissue in plants that brings water upward from the roots;
- 2) a leading global water technology company.

We're a global team unified in a common purpose: creating advanced technology solutions to the world's water challenges. Developing new technologies that will improve the way water is used, conserved, and re-used in the future is central to our work. Our products and services move, treat, analyze, monitor and return water to the environment, in public utility, industrial, residential and commercial building services settings. Xylem also provides a leading portfolio of smart metering, network technologies and advanced analytics solutions for water, electric and gas utilities. In more than 150 countries, we have strong, long-standing relationships with customers who know us for our powerful combination of leading product brands and applications expertise with a strong focus on developing comprehensive, sustainable solutions.

For more information on how Xylem can help you, go to www.xylem.com



Xylem Inc.
2881 East Bayard Street Ext., Suite A
Seneca Falls, NY 13148
Phone: (866) 325-4210
Fax: (888) 322-5877
www.xylem.com/goulds

Xylem is a registered trademark of Xylem Inc. or one of its subsidiaries. Goulds is a registered trademark of ITT Manufacturing Enterprises LLC and is used under license. All other trademarks or registered trademarks are property of their respective owners.

© 2023 Xylem Inc. B5-25HS R10 July 2023