

Models

LP122A/LP122A-4000/LP123/LP255



Contents:

Installation Instructions:	page 2
Pump Specifications - LP122A/LP122A-4000	page 3
Pump Specifications - LP123:	page 3
Exploded View:	page 4
Parts List/Kits:	page 5
Pump Specifications - LP255:	page 6
Troubleshooting Guide:	page 7
Suggested Maintenance Schedule:	page 7
Repair Instructions/Torque Specs.:	pages 8-10
Dimensions:	page 11
Warranty Information:	back page

INSTALLATION INSTRUCTIONS

Installation of the Giant Industries, Inc., pump is not a complicated procedure, but there are some basic steps common to all pumps. The following information is to be considered as a general outline for installation. If you have unique requirements, please contact Giant Industries, Inc. or your local distributor for assistance.

1. The pump should be installed flat on a base to a maximum of a 15 degree angle of inclination to ensure optimum lubrication.
2. The inlet to the pump should be sized for the flow rate of the pump with no unnecessary restrictions that can cause cavitation. Teflon tape should be used to seal all joints. If pumps are to be operated at temperatures in excess of 160° F, it is important to insure a positive head to the pump to prevent cavitation. See NPSH curve for LP122A Series/LP123 pumps.
3. The discharge plumbing from the pump should be properly sized to the flow rate to prevent line pressure loss to the work area. It is essential to provide a safety bypass valve between the pump and the work area to protect the pump from pressure spikes in the event of a blockage or the use of a shut-off gun.

4. Use of a dampener is necessary to minimize pulsation at drive elements, plumbing, connections, and other system areas. The use of a dampener with Giant Industries, Inc. pumps is optional, although recommended by Giant Industries, Inc. to further reduce system pulsation. Dampeners can also reduce the severity of pressure spikes that occur in systems using a shut-off gun. A dampener must be positioned downstream from the unloader.

5. Crankshaft rotation on Giant Industries, Inc. pumps should be made in the direction designated by the arrows on the pump crankcase. Reverse rotation may be safely achieved by following a few guidelines available upon request from Giant Industries, Inc. Required horsepower for system operation can be obtained from the charts on pages 3 and 6.

6. Before beginning operation of your pumping system, remember: Check that the crankcase and seal areas have been properly lubricated per recommended schedules. Do not run the pump dry for extended periods of time. Cavitation will result in severe damage. Always remember to check that all plumbing valves are open and that pumped media can flow freely to the inlet of the pump.

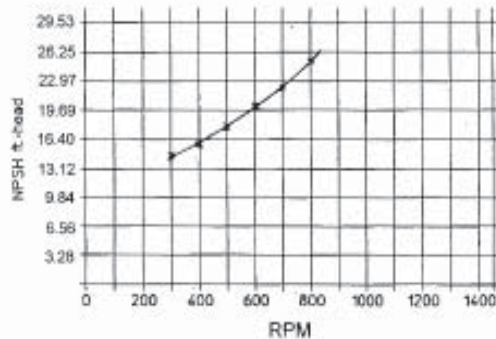

**LP122A/LP123
NPSHR Curve**

Finally, remember that high pressure operation in a pump system has many advantages. But, if it is used carelessly and without regard to its potential hazard, it can cause serious injury.

IMPORTANT OPERATING CONDITIONS

Failure to comply with any of these conditions invalidates the warranty.

1. Prior to initial operation, add oil to the crankcase so that oil level is between the two lines on the oil dipstick. **DO NOT OVERFILL.**

Use SAE 90 Industrial gear oil (Giant's p/n 01154)

Crankcase oil should be changed after the first 50 hours of operation, then at regular intervals of 500 hours or less depending on operating conditions.

2. Pump operation must not exceed rated pressure, volume, or RPM. A pressure relief device must be installed in the discharge of the system.

3. Acids, alkalines, or abrasive fluids cannot be pumped unless approval in writing is obtained before operation from Giant Industries, Inc.

4. Run the pump dry approximately 10 seconds to drain the water before exposure to freezing temperatures.

NOTE: Contact Giant Industries for Service School Information. Phone: (419)-531-4600

Specifications

Models LP122A/LP122A-4000/LP123

	U.S.	(Metric)
Volume (Continuous)	35.4 GPM	(134 l/m)
Volume (Intermittent)	40 GPM	(151.4 l/m)
Discharge Pressure (Continuous)	1300 PSI	(90 Bar)
Discharge Pressure (Intermittent)	2000 PSI	(138 Bar)
Inlet Pressure	Up to 90 PSI	(Up to 6.2 Bar)
Speed (Continuous)	Up to 800 RPM*	
Speed (Intermittent)	Up to 885 RPM**	
Plunger Diameter	1.65"	(42 mm)
Stroke	1.65"	(42 mm)
Crankcase Oil Capacity	116 fl.oz.	(3.43 liters)
Temperature of Pumped Fluids	Up to 160°F	(Up to 71°C)
Inlet Ports	2 x 1-1/2" NPT	
Discharge Ports	2 x 1" NPT	
Crankshaft Mounting	Either Side	
Shaft Rotation	Top of Pulley Towards Fluid End	
Weight	116 lbs.	(52.7 Kg)
Crankshaft Diameter	1.38"	(35 mm)
Valve Casing - LP122A	Aluminum Bronze	
Valve Casing - LP123	Brass	
Valve Casing - LP122A-4000	303 S.S.	
Volumetric Efficiency @ 800 RPM	0.96	
Mechanical Efficiency @ 800 RPM	0.85	

*Pump speeds of 640 RPM and above require a minimum inlet pressure of 12 psig.

**Pump speeds of 805 RPM and above require a minimum inlet pressure of 14 psig.

PULLEY INFORMATION

Pulley selection and pump speed are based on a 1725 RPM motor and "B" section belts. When selecting desired GPM, allow for a ±5% tolerance on pumps output due to variations in pulleys, belts and motors among manufacturers.

1. Select GPM required, then select appropriate motor and pump pulley from the same line.

2. The desired pressure is achieved by selecting the correct nozzle size that corresponds with the pump GPM.

HORSEPOWER INFORMATION

We recommend that a 1.1 service factor be specified when selecting an electric motor as the power source. To compute specific pump horsepower requirements, use the following formula:

$$HP = (GPM \times PSI) / 1440$$

LP122A/LP122A-4000/LP123 PULLEY SELECTION AND HORSEPOWER REQUIREMENTS								
GPM	PUMP PULLEY	MOTOR PULLEY	RPM	600 PSI	800 PSI	1000 PSI	1300 PSI	2000 PSI*
22.3	12.75"	3.95"	500	9.6	12.7	15.9	20.7	31.9
24.7	12.75"	4.35"	555	10.6	14.1	17.6	22.9	35.3
28.5	12.75"	4.95"	640	12.2	16.3	20.4	26.5	40.7
30.9	12.75"	5.35"	695	13.2	17.7	22.1	28.7	44.1
33.4	12.75"	5.75"	750	14.3	19.1	23.9	31.0	47.7
35.6	12.75"	6.15"	800	15.3	20.3	25.4	33.1	50.9
39.4	12.75"	6.50"	885*	16.9	22.5	28.1	36.6	56.3

*Intermittent duty only! - Consult factory!

Exploded View - LP122A/LP122A-4000/LP123/LP255

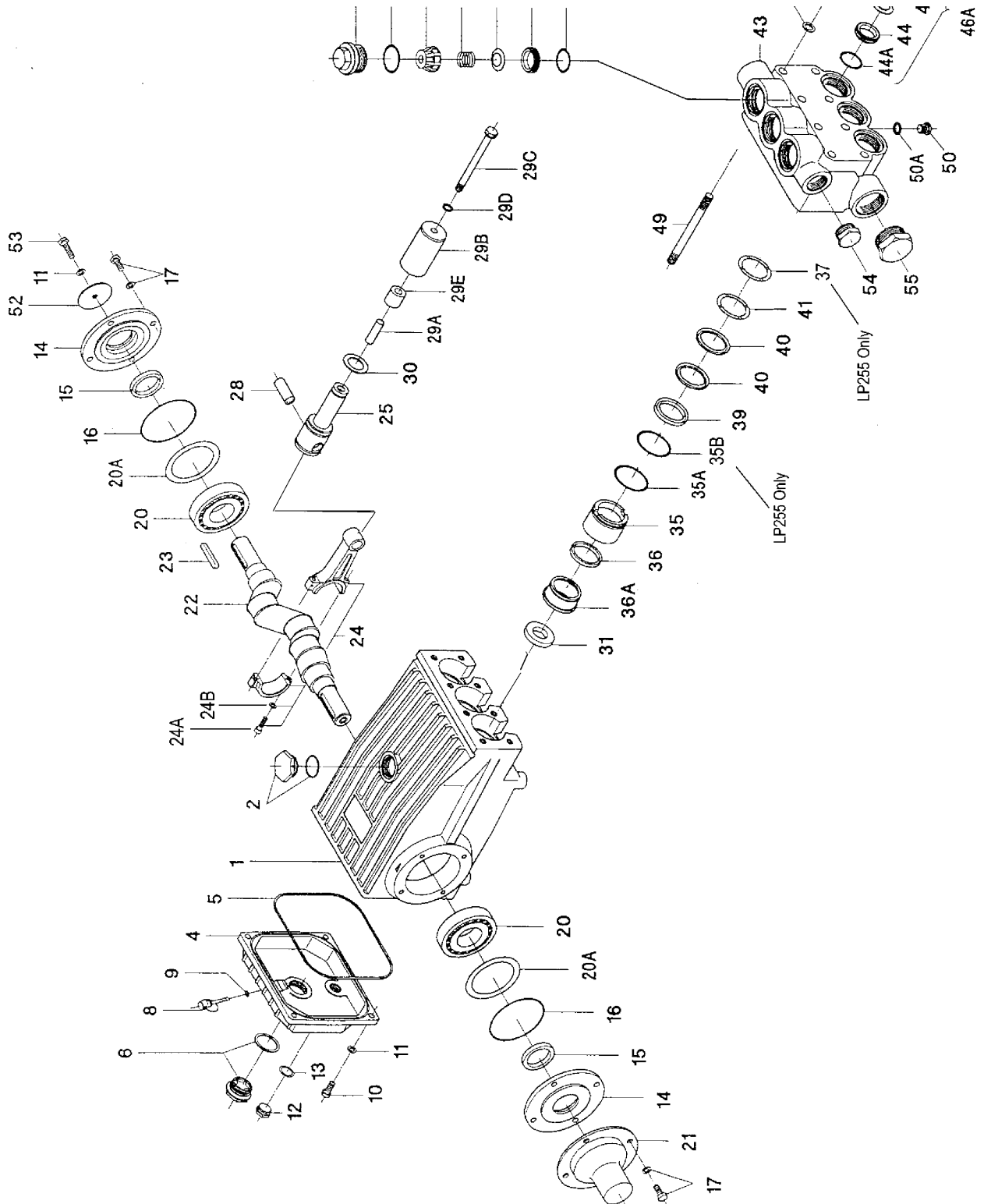

LP122A/LP122A-4000/LP123/LP255 PARTS LIST

A = LP122A

B = LP123

C = LP122-4000

E = LP255

ITEM	PARTNO.	DESCRIPTION	QTY.	ITEM	PARTNO.	DESCRIPTION	QTY.
1	07759	Crankcase	1	35B	13141	O-Ring (E only)	3
2	13000	Oil Filler Plug	1	36	13415	V-Sleeve, Weep (A-C)	3
4	06085	Crankcase Cover	1	36	13025	V-Sleeve, Weep (E)	3
5	07104	O-Ring	1	36A	13416A	Pressure Ring, Weep, (A, B, C)	3
6	07186	Oil Sight Glass W/Gasket	1	36A	06700	Pressure Ring (E)	3
8	06086	Oil Dipstick	1	37	06701	Support Disc (E only)	3
9	01009	O-Ring	1	39	07744	Pressure Ring, (A, B, C)	3
10	01010	Screw, (A, B, C, E)	4	39	13026	Pressure Ring (E)	6
11	01011-0400	Spring Washer, (A, B, C)	5	40	07745	V-Sleeve (A, B, C, D)	6
12	07109	Oil Drain Plug	1	40	13027	V-Sleeve (E)	6
13	07182	Gasket	1	41	07746	Support Ring, (A, B, C)	3
14	07111	Bearing Cover	2	41	06702	Support Ring (E)	3
15	07112	Crankshaft Seal	2	43	13343	Valve Casing, (A)	1
16	07113	O-Ring	2	43	06625	Valve Casing, (B)	1
17	07114	Hex Screw	8	43	13343-4000	Valve Casing, (C)	1
20	07116	Taper Roller Bearing	2	43	06703	Valve Casing, (E)	1
20A	07117	Fitting Disc, 0.1mm	2	44	07748	Valve Seat	6
20B	13001	Fitting Disc, 0.15mm	3	44A	07150	O-Ring	6
21	07118	Shaft Protector	1	45	07749	Valve Plate	6
22	13242	Crankshaft	1	46	07750	Valve Spring	6
23	13243	Key	1	46A	07751	Valve Assy. Complete (#44, 44A, 45, 46, & 47)	6
24	13340	Connecting Rod Assy.	3	47	07752	Spring Retainer	6
24A	13277	Hex Screw	6	48	07753	Plug, (A)	6
24B	13278	Spring Washer	6	48	06504	Plug, (B, E)	6
25	13341	Crosshead Plunger Base Assy.	3	48	06089	Plug, (C)	6
28	13232	Crosshead Pin	3	48A	12055	O-Ring	6
29A	07735	Centering Sleeve	3	49	07157	Stud Bolt	8
29B	07736	Plunger Pipe (A-C)	3	49A	07158	Nut	8
29B	13022	Plunger Pipe (E)	3	49B	07159	Washer	8
29C	07737	Plunger Bolt	3	50	07423	Plug, (A, B, E)	1
29D	07755	Copper Gasket	3	50	07423-0100	Plug, (C)	1
29E	06087	Spacer Pipe	3	50A	07161	Gasket	1
30	07789	Flinger	3	52	13020	Disk for Crankshaft	1
31	07133	Radial Shaft Seal	3	53	06607	Hexagon Screw	1
35	13342	Seal Sleeve, (A, B, C)	3	54	07756	Plug 1" NPT, (A, C)	1
35	06699	Seal Sleeve (E)	3	54	06626	Plug 1" NPT, (B, E)	1
35A	07740	O-Ring	3	55	07757	Plug 1-1/2" NPT, (A, C)	1
				55	06627	Plug, 1-1/4" NPT, (B, E)	1

NOTE: For LP122 pumps manufactured prior to 5/94, which need weep seal replacement, change the pressure ring (36) to the newer style (p/n 13416) and use the new style weep seal (p/n 13415) in your pumps.

LP122A/LP122A-4000/LP123/LP255 PUMP REPAIR KITS

Plunger Packing Kit

09477 (LP122A, LP123, LP122A-4000)

(for pumps manufactured after 4/98)

Item	Part #	Description	Qty.
35A	07740	O-ring	3
36	13415	V-Sleeve, Weep	3
40	07745	V-Sleeve	6

Plunger Packing Kit

09535 (LP255)

Item	Part #	Description	Qty.
35A	07740	O-ring	3
35B	13141	O-Ring	3
36	13025	V-Sleeve weep	3
40	13027	V-Sleeve	6

Valve Assembly Kit - #09136

Item	Part #	Description	Qty.
46A	07751	Valve Assembly, Complete	3
48A	12055	O-Ring	3

Specifications

Model LP255

	U.S.	(Metric)
Volume	26.0 GPM	(98 l/min)
Discharge Pressure	2175 PSI	150 Bar)
Inlet Pressure	Up to 90 PSI	Up to 6.2 Bar)
Speed		Up to 1000 RPM
Plunger Diameter	1.26"	(32 mm)
Stroke	1.65"	(42 mm)
Crankcase Oil Capacity	116 fl.oz.	(3.43 liters)
Temperature of Pumped Fluids	Up to 160°F	(70 °C)
Inlet Ports		2 x 1-1/2" NPT
Discharge Ports		2 x 1" NPT
Crankshaft Mounting		Either Side
Shaft Rotation	Top of Pulley Towards Fluid End	
Weight	116 lbs.	(52.7 Kg)
Crankshaft Diameter	1.38"	(35 mm)
Valve Casing		Brass
Volumetric Efficiency @ 800 RPM		0.96
Mechanical Efficiency @ 800 RPM		0.85

PULLEY INFORMATION

Pulley selection and pump speed are based on a 1725 RPM motor and "B" section belts. When selecting desired GPM, allow for a ±5% tolerance on pumps output due to variations in pulleys, belts and motors among manufacturers.

1. Select GPM required, then select appropriate motor and pump pulley from the same line.
2. The desired pressure is achieved by selecting the correct nozzle size that corresponds with the pump GPM.

HORSEPOWER INFORMATION

We recommend that a 1.1 service factor be specified when selecting an electric motor as the power source. To compute specific pump horsepower requirements, use the following formula:

$$HP = (GPM \times PSI) / 1440$$

LP255 PULLEY SELECTION AND HORSEPOWER REQUIREMENTS							
PUMP PULLEY	MOTOR PULLEY	RPM	GPM	1000 PSI	1500 PSI	2000 PSI	2175 PSI
12.75"	3.95"	500	13	9.0	13.5	18.1	19.6
12.75"	4.35"	640	16.6	11.5	17.3	23.1	25.1
12.75"	4.95"	750	19.5	13.5	20.3	27.1	29.5
12.75"	5.35"	805	20.9	14.5	21.8	29.0	31.6
12.75"	5.75"	865	22.5	15.6	23.4	31.3	34.0
12.75"	6.15"	920	23.9	16.6	24.9	33.2	36.1
12.75"	6.50"	1000	26	18.1	27.1	36.1	39.3

PUMP SYSTEM MALFUNCTION

<u>MALFUNCTION</u>	<u>CAUSE</u>	<u>REMEDY</u>
The Pressure and/ or the Delivery Drops	Worn packing seals Broken valve spring Belt slippage Worn or Damaged nozzle Fouled discharge valve Fouled inlet strainer Worn or Damaged hose Worn or Plugged relief valve on pump Cavitation pump for restrictions Unloader	Replace packing seals Replace spring Tighten or Replace belt Replace nozzle Clean valve assembly Clean strainer Repair/Replace hose Clean, Reset, and Replace worn parts Check suction lines on inlet of Check for proper operation
Water in crankcase	High humidity Worn seals	Reduce oil change interval Replace seals
Noisy Operation	Worn bearings oil with Cavitation	Replace bearings, Refill crankcase recommended lubricant Check inlet lines for restrictions and/or proper sizing
Rough/Pulsating Operation with Pressure Drop	Worn packing Inlet restriction Accumulator pressure Unloader Cavitation	Replace packing Check system for stoppage, air leaks, correctly sized inlet plumbing to pump Recharge/Replace accumulator Check for proper operation Check inlet lines for restrictions and/or proper size
Pump Pressure as Rated, Pressure Drop at Gun	Restricted discharge plumbing	Re-size discharge plumbing to Flow Rate of Pump
Excessive Leakage	Worn plungers Worn packing/seals Excessive vacuum Cracked plungers Inlet pressure too high	Replace plungers Adjust or Replace packing seals Reduce suction vacuum Replace plungers Reduce inlet pressure
High Crankcase Temperature	Wrong Grade of oil Improper amount of oil in crankcase	Giant oil is recommended Adjust oil level to proper amount

Preventative Maintenance Check-List & Recommended Spare Parts List

Check	Daily	Weekly	50hrs	Every 500 hrs	Every 1500 hrs	Every 3000 hrs
Oil Level/Quality	X					
Oil Leaks	X					
Water Leaks	X					
Belts, Pulley		X				
Plumbing		X				
Recommended Spare Parts						
Oil Change (1 Gallon) p/n 1154			X	X		
Seal Spare Parts (1 kit/pump) (See page 5 for kit list)					X	
Oil Seal Kit (1 kit/pump) (See page 5 for kit list)					X	
Valve Spare Parts (1 kit/pump) (See page 5 for kit list)						X

LP122A/LP122A-4000/LP123/LP255 - Repair Instructions



1. With a 30mm wrench, remove the six (6) plugs (48) from the valve casing (43). Inspect the o-rings (48A) and replace if necessary.

Remove the complete valve assembly (46A) by threading a 12mm bolt into the spring retainer and pulling straight out.

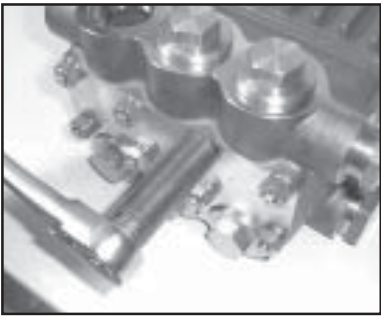

3. Remove the eight (8) hex nuts (49A) with a 19mm wrench. Tap the back of the manifold (43) with a rubber mallet to dislodge and slide off the studs.

5. If there are signs of oil leaking through the plunger oil seals, then replacement is necessary. Disassemble the gear end and push out the seals from the back of the pump.

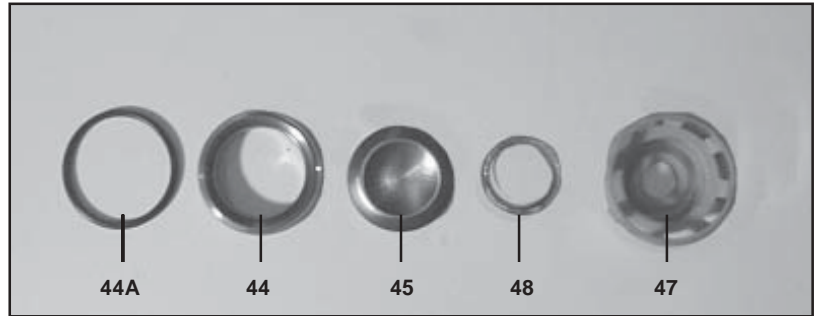

2. To disassemble the valve, screw the bolt into the retainer until the valve plate (45) presses the valve seat (44) out of the spring retainer. Examine all parts and replace if necessary. If the seat doesn't come out, use a valve puller to remove.

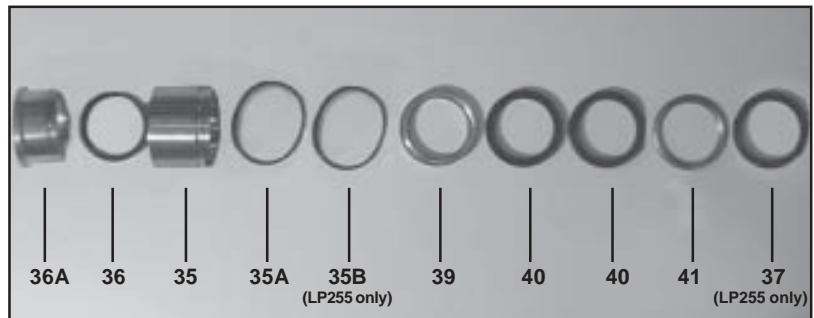

4. Remove the seal sleeve (35) from the manifold and/or crankcase. Remove the pressure rings (39&36A), v-sleeves (40&36), support ring (41) and o-rings (35A and 35B in Lp255A only) from the manifold and seal sleeve, respectively. For LP255 only, remove support ring (37). Examine seal seals carefully and replace if worn. Clean all parts.

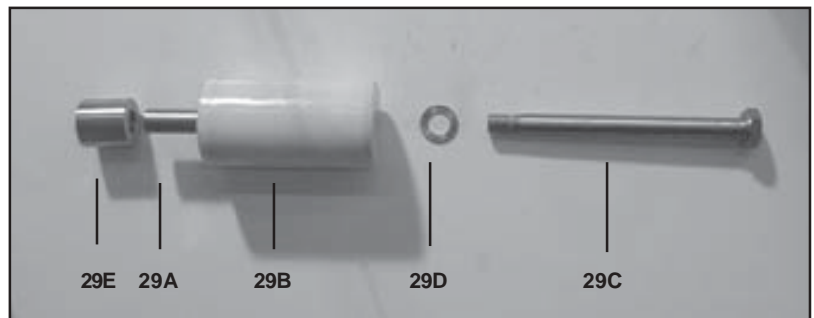

6. Inspect surface of plunger pipe (29B) carefully. Remove any chemical or mineral deposits taking care not to damage the surface of the plunger. If plunger pipe is worn, remove the plunger bolt (29C), plunger pipe (29B) and spacer (29E). Replace worn parts necessary. **Note: *Always use a new copper gasket (29) when repairing the plunger assembly.***

LP122A/LP122A-4000/LP123/LP255 - Repair Instructions

TO REASSEMBLE PROCEED AS FOLLOWS:

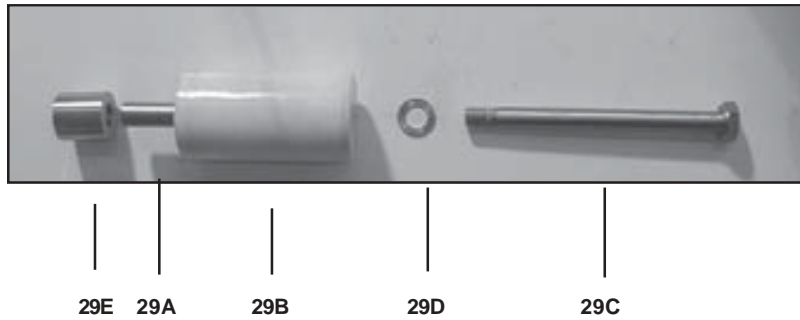

7. If previously disassembled thoroughly clean all exposed surfaces on the spacer (29E) and all exposed threads on the plunger bolt (29C) and the steel plunger base (25). Threads **MUST** be free of old loc-tite and any other material such as oil, grease, etc. This is necessary to ensure proper curing of new loc-tite. Giant recommends cleaning the threads with acetone or other suitable cleaner. Reassemble plunger assembly parts (29A, 29B, & 29E) using a new copper gasket (29D) and the cleaned plunger bolt (29C). Slide the bolt through the center of the four (4) pieces so that the threaded end is exposed. Apply several drops of loc-tite 243 (or equivalent) adhesive to the threads. Thread into steel plunger base and tighten to 26 ft.-lbs. **BE CERTAIN ALL PARTS ARE CENTERED WITH THE BOLT!**

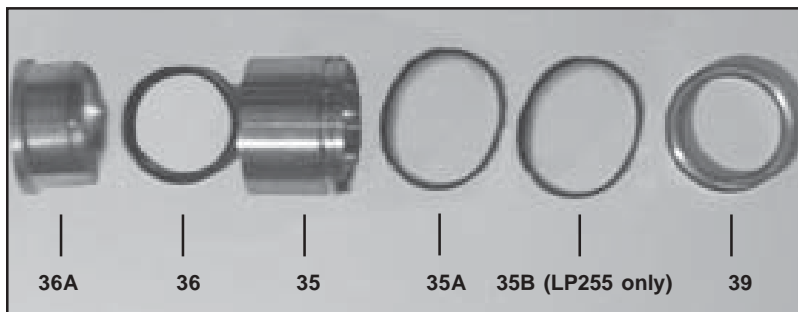

8. Lubricate weep seal (36). Place, weep seal (36), and pressure ring (36A) into the seal sleeve (35). Assemble the o-ring (35A and 35B for LP255 only) onto seal sleeve and lubricate.

9. For LP255 pumps, insert support ring (37) into valve casing (43). Place support ring (41) and v-sleeves (40) into valve casing.

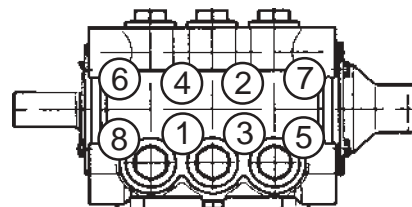

10. Place entire manifold/seal sleeve assembly over the studs and push firmly until seated against the crankcase.

11. Tighten hex nuts (49A) in a crosswise pattern (shown above) to 60 ft.-lbs.

LP122A/LP122A-4000/LP123/LP255 - Repair Instructions



12. Next, place valve assemblies (46A) into manifold after first lubricating the o-ring (44A). Seat firmly into manifold.



13. Replace plug with o-ring (48, & 48A) and tighten to 160 ft.-lbs.

14. Fill crankcase with approximately 116 fluid ounces of Giant oil or equivalent SAE 90 industrial gear oil and check oil level of the crankcase with the dipstick. Proper level is center of two lines. Reinstall your Giant LP pump into your system.

LP122A/LP122A-4000/LP123/LP255 TORQUE SPECIFICATIONS

<u>Position</u>	<u>Item#</u>	<u>Description</u>	<u>Torque Amount</u>
10	01010	Screw, Cover	125 in.-lbs.
17	07114	Hex Screw, Bearing Cover	125 in.-lbs.
24A	13277	Hex Screw, Connecting Rod	250 in.-lbs.
29C	07737	Plunger Bolt	26 ft.-lbs.
48	06504/06089	Plug, Valve	160 ft.-lbs.
49A	07158	Nut, Stud Bolt	60 ft.-lbs.

Contact Giant Industries or your local distributor for maintenance of the gear end of your pump. Phone: 419/531-4600

Contact Giant Industries for service school information. Phone: (419) 531-4600

LP122A/LP123/LP255 Dimensions (mm)

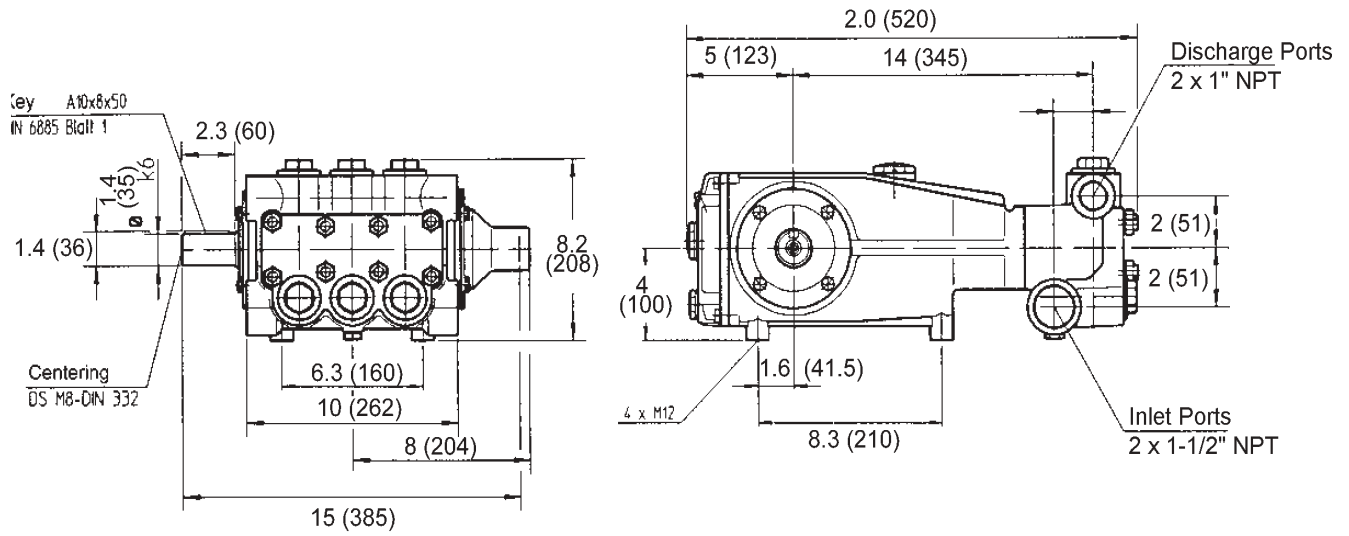

LP122A-4000 Dimensions (mm)

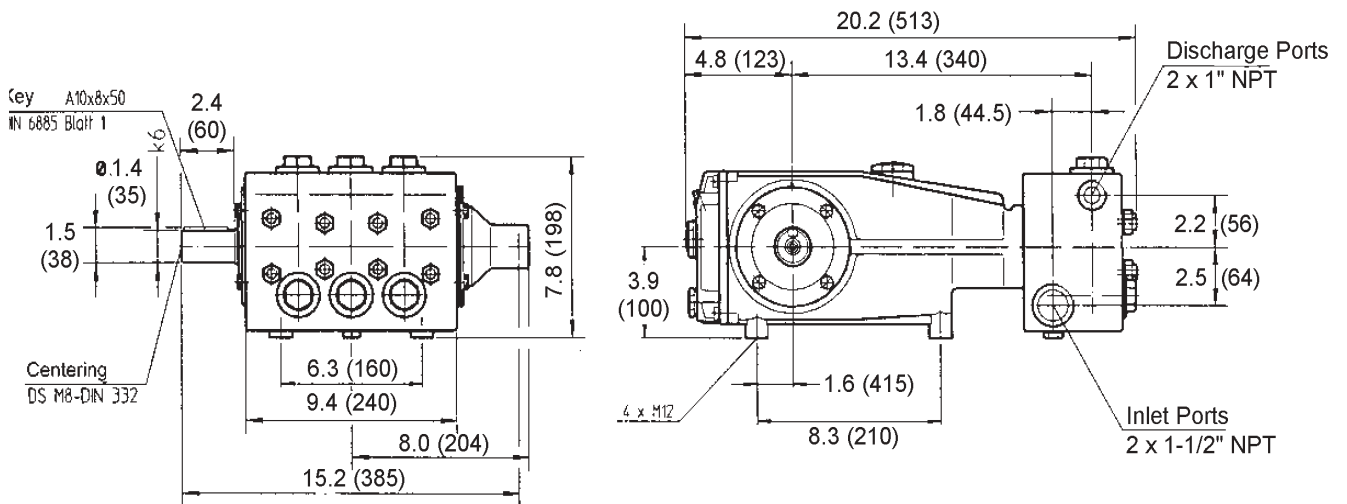

GIANT INDUSTRIES LIMITED WARRANTY

Giant Industries, Inc. pumps and accessories are warranted by the manufacturer to be free from defects in workmanship and material as follows:

1. For portable pressure washers and self-service car wash applications, the discharge manifolds will never fail, period. If they ever fail, we will replace them free of charge. Our other pump parts, used in portable pressure washers and in car wash applications, are warranted for five years from the date of shipment for all pumps used in NON-SALINE, clean water applications.
2. One (1) year from the date of shipment for all other Giant industrial and consumer pumps.
3. Six (6) months from the date of shipment for all rebuilt pumps.
4. Ninety (90) days from the date of shipment for all Giant accessories.

This warranty is limited to repair or replacement of pumps and accessories of which the manufacturer's evaluation shows were defective at the time of shipment by the manufacturer. The following items are NOT covered or will void the warranty:

1. Defects caused by negligence or fault of the buyer or third party.
2. Normal wear and tear to standard wear parts.
3. Use of repair parts other than those manufactured or authorized by Giant.
4. Improper use of the product as a component part.
5. Changes or modifications made by the customer or third party.
6. The operation of pumps and or accessories exceeding the specifications set forth in the Operations Manuals provided by Giant Industries, Inc.

Liability under this warranty is on all non-wear parts and limited to the replacement or repair of those products returned freight prepaid to Giant Industries which are deemed to be defective due to workmanship or failure of material. A Returned Goods Authorization (R.G.A.) number and completed warranty evaluation form is required prior to the return to Giant Industries of all products under warranty consideration. Call (419)-531-4600 or fax (419)-531-6836 to obtain an R.G.A. number.

Repair or replacement of defective products as provided is the sole and exclusive remedy provided hereunder and the MANUFACTURER SHALL NOT BE LIABLE FOR FURTHER LOSS, DAMAGES, OR EXPENSES, INCLUDING INCIDENTAL AND CONSEQUENTIAL DAMAGES DIRECTLY OR INDIRECTLY ARISING FROM THE SALE OR USE OF THIS PRODUCT.

THE LIMITED WARRANTY SET FORTH HEREIN IS IN LIEU OF ALL OTHER WARRANTIES OR REPRESENTATION, EXPRESS OR IMPLIED, INCLUDING WITHOUT LIMITATION ANY WARRANTIES OR MERCHANTABILITY OR FITNESS FOR A PARTICULAR PURPOSE AND ALL SUCH WARRANTIES ARE HEREBY DISCLAIMED AND EXCLUDED BY THE MANUFACTURER.



GIANT INDUSTRIES, INC., 900 N. Westwood Avenue, P.O. Box 3187, Toledo, OH 43607
PHONE: (419) 531-4600, FAX: (419) 531-6836, www.giantpumps.com
© Copyright 2006 Giant Industries, Inc.