

# **FILL-RITE®**

## **SERIES 900 METER**

### **Owner's Operation & Safety Manual**

**Models 901, 901N, 901T, 9011.5,  
901N1.5, 901T1.5, 901MK300,  
901MK4200**

### **SAFETY INSTRUCTIONS**

To ensure safe and efficient operation, it is essential to read each of these warnings and precautions, and to follow all instructions listed in this manual.

1. **Improper use or installation of this product can cause serious bodily injury or death.**
2. DO NOT smoke near meter or use meter near an open flame when dispensing flammable fluids. Fire could result.
3. Do not exceed 50 PSI / 3.5 BARS line pressure.
4. **CAUTION: DO NOT INSTALL ADDITIONAL FOOT VALVE OR CHECK VALVE DURING INSTALLATION WITHOUT PRESSURE RELIEF VALVE. CRACKING MAY RESULT.**
5. This product should not be used for fluid transfer into aircraft.
6. This product is not suited for use with fluids for human consumption, including potable water.

### **INSTALLATION**

Meters are furnished for horizontal piping; left to right flow. Flow ports can be changed to any of four positions for horizontal or vertical piping and for either direction of flow.

1. Determine direction for fluid to flow.
2. Install meter observing directional arrow on casting.
3. Remove four screws (item 28).
4. Rotate meter cover assembly (item 37) to desired orientation.
5. Replace four screws (item 28).

### **CALIBRATION**

The Fill-Rite Series 900 meters can be calibrated for either U.S. gallons or liters. Calibration is required upon installation, after disassembly, after significant wear or when metering a different viscosity fluid. Depending on the model, Series 900 meters are factory calibrated in either U.S. gallons or liters using mineral spirit. Calibration must be done between 6 and 40 GPM (23 and 151 LPM).

Meter calibration can be easily changed by following the calibration procedure. A container of KNOWN volume will be needed for the calibration procedure. For the 900 Series meter, a five gallon container or larger should be used.

### **Procedure for Calibration:**

1. For the most accurate calibration, install the meter in the application. Fill a container to a known volume with the liquid to be measured.
2. If meter amount is incorrect, turn calibration screw (item 31) counterclockwise for less liquid, or clockwise for more liquid.
3. Repeat steps 1 and 2 until calibration is acceptable.

### **OPERATING INSTRUCTIONS**

For accurate measurement and to prevent meter damage, meter and piping must always be filled with liquid and free of air. Meter should be calibrated per instructions in this manual prior to its use.

1. Stop flow of liquid.
2. Reset register to "0".
3. Meter is ready for use. Start flow of liquid. Do not exceed 50 PSI of line pressure.

### **MAINTENANCE**

Meter should operate maintenance free. However, certain liquids can dry out while in the meter housing, causing the meter to stop. If this happens, meter should be thoroughly cleaned (see instructions below).

#### **Cleaning Instructions:**

Run a flushing fluid through meter. For a more thorough cleaning, disassemble meter per "ASSEMBLY / DISASSEMBLY" section, "Meter Chamber Assembly" subsection. Rinse all meter components. Recalibrate meter following calibration instructions above.

#### **Storage:**

If meter is to be stored for a period of time, clean thoroughly. This will help protect meter from damage.

### **TROUBLESHOOTING GUIDE**

#### **Counter is reading high or low:**

Check calibration and recalibrate if necessary. Check for air in product and repair air leaks. Measuring chamber or gears could be sticking. Correct by cleaning or replacing internal metering components.

#### **Shaft seal leakage:**

Possible causes are dirty or damaged seals. Correct by cleaning o-ring and seat area or replacing seal.

#### **Gasket leakage:**

Correct loose gasket by tightening joints. Clean dirty gaskets and seat area. Replace damaged gaskets. If caused by high pressure, install pressure relief valve to allow high pressure to bleed back to tank.

#### **Low flow capacity:**

Clean clogged meter chamber; clean or replace screens and filters in piping.

#### **Meter body cracks:**

Install pressure relief valve to allow high pressure to bleed back to tank.

#### **Nutating disc breaks:**

Avoid flow surge by putting shut-off valve on outlet of meter; place meter as close as possible to pump; keep piping full of liquid.

**FLUID COMPATIBILITY**

The 900 is compatible with the following fluids:

- Diesel Fuel, Gasoline, Kerosene, Mineral Spirits, Heptane, and Hexane

The 900 is NOT compatible with the following fluids:

- Bleach, Hydrochloric Acid, Ink, Sulfuric Acid, and Salt Water

If in doubt about compatibility of a specific fluid, contact supplier of fluid to check for any adverse reactions to the following wetted materials.

Ryton	Aluminum	Stainless Steel
Flourocarbon	Buna N	Polyester
Teflon®	Nickel	

**ASSEMBLY & DISASSEMBLY**

Meter consists of a chamber housing, measuring chamber, gear train, counter assembly and cover. Meter can be completely disassembled without disturbing piping.

**Counter Assembly**

For access to counter assembly, remove reset knob (item 15) by grasping edges and pulling firmly. Remove two screws (item 14) and lift bezel (item 11) off. Remove two screws (item 12) to detach counter face (item 13). Remove two screws (item 9) to extract counter (item 10). Reassemble by reversing procedure.

**Meter Chamber Assembly**

To expose meter chamber assembly, gear train and seal, remove four screws (item 28). Meter chamber assembly consists of upper and lower chambers, a nutating disc and four screws. Meter chamber assembly (item 3) can be dislodged by removing four screws (item 5). Reassemble by reversing procedure.

If replacement of any components of the meter chamber assembly is required, the complete assembly must be replaced due to the precise method of its construction. This assures a proper fit and a correctly operating chamber.

**Gear Train and Seal**

To disassemble gear train and seal, remove two screws (item 8) and gear frame (item 6). Remove cluster gear (item 18), washer (item 19), and shaft (item 17). Remove drive gear (item 24) and washers (item 23) by rotating and pulling drive gear. Remove O-ring seal (item 25).

When reassembling seal, lubricate O-ring with oil or petroleum jelly and replace in cover. Place washer on drive gear shaft. Carefully rotate and push shaft through O-ring and cover to prevent damage to O-ring. Shaft must then be guided into pinion bevel (item 27) if counter has not been removed. Replace remaining parts to complete assembly by reversing disassembly procedure.

**REPAIR**

Meters needing repair should be taken to an authorized repair shop. Meters must be thoroughly triple-rinsed before being taken in for repair.

**PRIOR TO SERVICE, ADHERE TO FOLLOWING INSTRUCTIONS:**

**Meters must be triple-rinsed and accompanied by a note indicating the chemicals which have been pumped through the unit. Meters not adhering to these specifications may be refused service.**

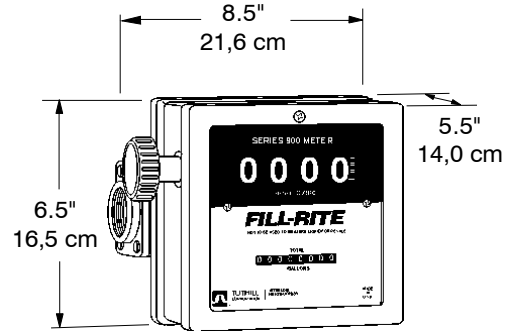

WHEN ORDERING REPAIR PARTS, BE SURE TO GIVE REPLACEMENT PART NUMBER, DATE OF MANUFACTURE AND METER SERIES NUMBER. THIS WILL ENSURE THAT THE CORRECT REPLACEMENT PART IS SUPPLIED. TOLL FREE CUSTOMER CARE NUMBER 800 634 2695

900 SERIES REPAIR PARTS KITS	
900KTF8119	Meter Repair Kit, U.S. Gallon (Standard Seals) (Includes items 2-4, 6, 17-19, 21-25, 27, 30, 32)
900KTF8120	Meter Repair Kit, U.S. Gallon (Fluorocarbon Seals) (Includes items 2-4, 6, 17-19, 21-25, 27, 30, 32)
900KTF8121	Meter Repair Kit, Liter (Standard Seals) (Includes items 2-4, 6, 17-19, 21-25, 27, 30, 32)
900KTF8123	Meter Repair Kit, Liter (Fluorocarbon Seals) (Includes items 2-4, 6, 17-19, 21-25, 27, 30, 32)

901 METER KIT	
901MK300	901 Meter Kit for FR300 Gallon (Includes 901 meter with 800F4390 1 x 2 Nipple, 900F8082 Meter Flange)
901LMK300	901 Meter Kit for FR300 Liter (Includes 901 meter with 800F4390 1 x 2 Nipple, 900F8082 Meter Flange)
901NMK300	901 Meter Kit for FR300 Gallon Nickel plated (Includes 901 meter with 800F4390 1 x 2 Nipple, 900G9478 Nickel plated Meter Flange)
901MK4200	900 Meter Kit for FR4200 Gallon (Includes 901 meter with 304F7924 1 x 5 Nipple, 1200F6732 1 x 4 Nipple, 304F7885 Elbow, 305F0998 Outlet Fitting)
901LMK4200	900 Meter Kit for FR4200 Liter (Includes 901 meter with 304F7924 1 x 5 Nipple, 1200F6732 1 x 4 Nipple, 304F7885 Elbow, 305F0998 Outlet Fitting)
901NMK4200	900 Meter Kit for FR4200 Gallon Nickel plated (Includes 901 meter with 304F7924 1 x 5 Nipple, 1200F6732 1 x 4 Nipple, 304F7885 Elbow, 900G9477 Nickel plated Outlet Fitting)

## 900 SERIES METER PARTS LIST

ITM. NO.	PART NO.	DESCRIPTION	QTY.
1	900F8051	Meter Housing	1
	900F8102	Meter Housing-Nickel Plated	Opt.
	900F8101	Meter Housing-Teflon® Coated	Opt.
2	300F7744	Inlet/Outlet Gasket Buna-N	2
	300F7788	Inlet/Outlet Gasket Fluorocarbon	Opt.
3	900F8087	Meter Chamber Assembly	1
4	900F8067	Cover Gasket Buna-N	1
	900F8068	Cover Gasket Fluorocarbon	Opt.
5	900G8886	#10-24 x 5/8 TORX PH	4
6	900F8066	Gear Frame	1
7	900F8053	Meter Cover (Includes Item 20)	1
	900F8104	Meter Cover - Nickel Plated	Opt.
	900F8103	Meter Cover - Teflon® Coated	Opt.
8	VP1400F8822	#10-24 1/2 TORX	2
9	900F4007	#8-32 x 5/16 PHMS, ACR II, TT	2
10	900F8070	Counter Assembly - U.S. Gallon	1
	900F8071	Counter Assembly - Liter	Opt.
11	900F8069	Bezel	1
12	35F1397	#4 x 3/8 PHTS	2
13	900F8072	Counter Face	1
	900F8089	Counter Face - Litre	Opt.
14	900G8504	#8 x 5/8 ZN/PL PH OVAL	2
15	800G8870	Knob	1
17	800F3820	Shaft - Cluster Gear	1
18	800F3841	Cluster Gear - U.S. Gallon	1
	800F3843	Cluster Gear - Liter	Opt.
19	800F3830	Washer	1
20	900F8063	Driver Pinion Shaft (Included w Item 7)	1
21	900F8065	Retaining Ring	1
22	900F8064	Driver Pinion	1
23	800F3980	Washer	3

ITM. NO.	PART NO.	DESCRIPTION	QTY.
24	800F3845	Drive Gear - U.S. Gallon	1
	800F3846	Drive Gear - Liter	Opt.
25	800F4191	O-Ring (5-106) Fluorocarbon	1
27	800F3959	Pinion Bevel	1
28	700F2810	5/16-18 x 7/8 HHCS	4
29	900F8158	Seal Screw	1
30	800F4449	O-Ring (-012) Fluorocarbon	1
31	900F8160	Adjustment Screw (Includes Item 32)	1
32	900F8159	O-Ring (-010) (inc. in item 31) Fluorocar	1
33	1200F6721	1/4-20 x 3/4 HHCS (1" meters)	8
34	900F8076	1" Meter Flange	2
	900F8106	1" Meter Flange - Nickel Plated	Opt.
	900F8105	1" Meter Flange - Teflon® Coated	Opt.
35	900F8092	1-1/2" Meter Flange	Opt.
	900F8110	1-1/2" Meter Flange Nickel Plated	Opt.
	900F8109	1-1/2" Meter Flange Teflon® Coated	Opt.
36	900F8091	1/4-20 x 1-1/2 HHCS (1-1/2" meters)	Opt.
37	900F8045	Meter Cover Assembly U.S. Gallon	1
	900F8047	Meter Cover Assembly-U.S. Gallon Nickel Plated	Opt.
	900F8046	Meter Cover Assembly-U.S. Gallon Teflon® Coated	Opt.
	900F8048	Meter Cover Assembly - Liter	Opt.
	900F8050	Meter Cover Assembly - Liter Nickel Plated	Opt.
	900F8049	Meter Cover Assembly - Liter Teflon® Coated	Opt.

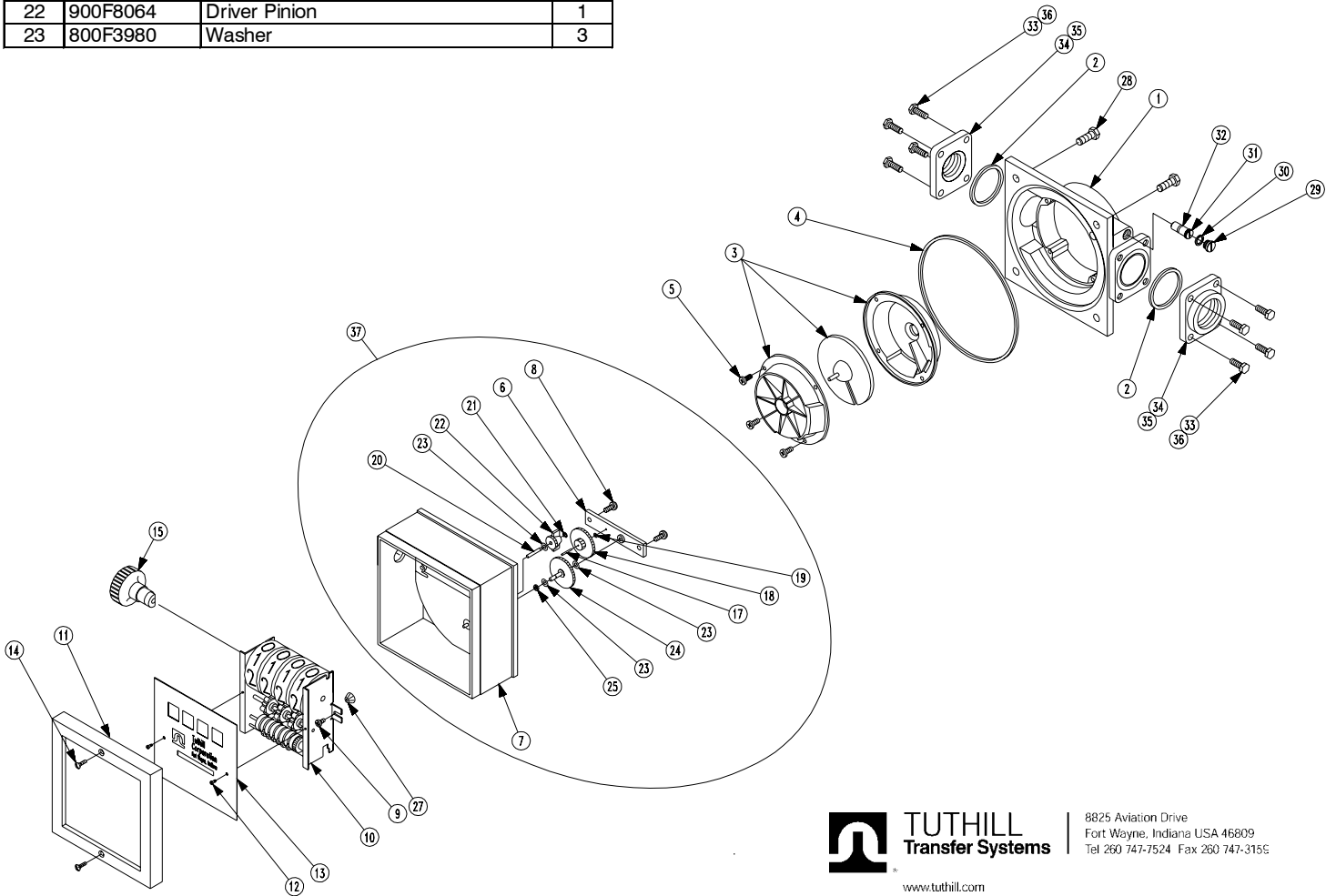

**TUTHILL**  
Transfer Systems  
www.tuthill.com

8825 Aviation Drive  
Fort Wayne, Indiana USA 46809  
Tel 260 747-7524 Fax 260 747-3155

## PRODUCT WARRANTY

Tuthill Transfer Systems ("Manufacturer") warrants to each consumer buyer of its Fill-Rite products (the "Buyer"), from the date of invoice or sales receipt, that goods of its manufacture ("Goods") will be free from defects of material and workmanship. Duration of this warranty is as follows:

- Heavy Duty Products - Two years
- Standard Duty Products – One year
- Economy Duty Products – One year
- Cabinet pumps, Parts, and Accessories - One year

Manufacturer's sole obligation under the foregoing warranties will be limited to either, at Manufacturers' option, replacing or repairing defective Goods (subject to limitations hereinafter provided) or refunding the purchase price for such Goods theretofore paid by the Buyer, and Buyer's exclusive remedy for breach of any such warranties will be enforcement of such obligations of Manufacturer. If Manufacturer so requests the return of the Goods, the Goods will be redelivered to Manufacturer in accordance with Manufacturer's instructions F.O.B. Factory. The remedies contained herein shall constitute the sole

recourse of the Buyer against Manufacturer for breach of warranty. IN NO EVENT SHALL MANUFACTURER'S LIABILITY ON ANY CLAIM FOR DAMAGES ARISING OUT OF THE MANUFACTURE, SALE, DELIVERY, OR USE OF THE GOODS EXCEED THE PURCHASE PRICE OF THE GOODS. The foregoing warranties will not extend to Goods subjected to misuse, neglect, accident or improper installation or maintenance, or which have been altered or repaired by anyone other than Manufacturer or its authorized representative. THE FOREGOING WARRANTIES ARE EXCLUSIVE AND IN LIEU OF ALL OTHER WARRANTIES OF MERCHANTABILITY, FITNESS FOR PURPOSE OF ANY OTHER TYPE, WHETHER EXPRESS OR IMPLIED. No person may vary the foregoing warranties and remedies except in writing signed by a duly authorized officer of Manufacturer. Warranties or remedies that differ from the foregoing shall not otherwise be binding on Manufacturer. The Buyer's acceptance of delivery of the Goods constitutes acceptance of the foregoing warranties and remedies, and all conditions and limitations thereof.