

Owner's Operation & Safety Manual

SOTERA SYSTEMS

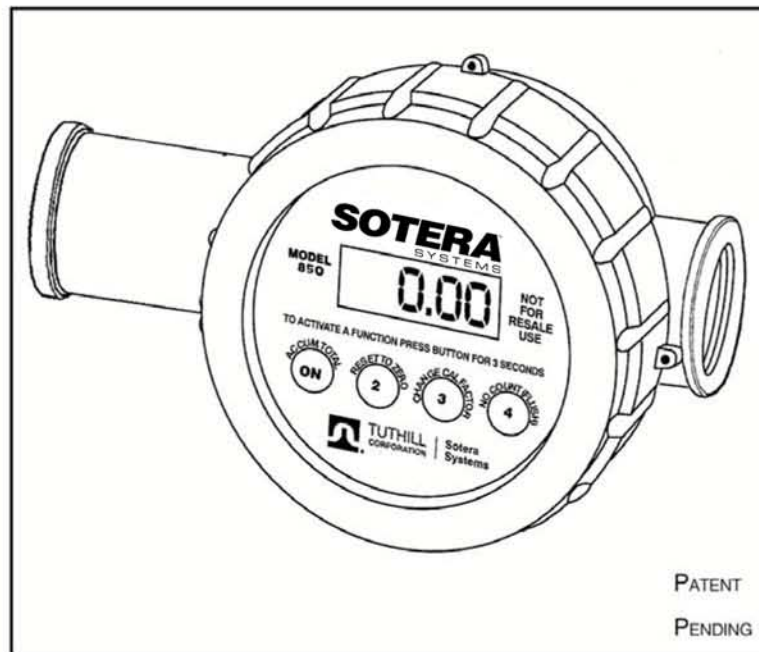
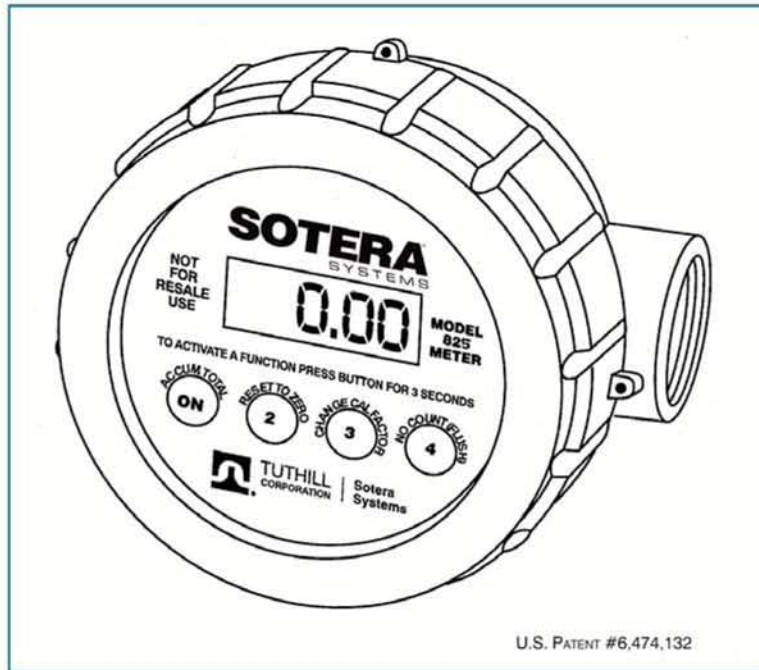

825 DIGITAL METER
850 DIGITAL METER

Dear Sotera Customer,

Thank you for buying a Sotera product. Sotera Systems represents a new age in transfer and measuring equipment. This instruction sheet contains valuable information about your new equipment and its operating and service requirements. Please take a few minutes to review this material carefully.

Sotera Systems' mission is to provide handling systems that deliver the most accurate, safe, convenient and economical transfer systems for users of chemicals.

If, for any reason, any of the products do not meet your performance expectations we want to hear from you. Your comments and suggestions are requested and appreciated. Thank you again for buying a Sotera Systems product. We look forward to serving you in the future.

The Sotera Systems Team
1-800-796-0614



SAFETY INSTRUCTIONS

To ensure safe and efficient operation, it is essential to read and follow each of the following warnings and precautions.

1. Agricultural herbicides flowing through the meter may be harmful to your health. Use and disposal of these products is controlled by federal, state or local laws and procedures.
2. Conform to fluid manufacturer's recommended handling procedures when using product and when cleaning meter.
3. Do not exceed an internal meter pressure of 120PSI /8.2 Bars.
4. **Improper use or installation of this product can cause serious bodily injury or death.**
5. The 825 & 850 Digital Meter is not a flammable fluid meter. Do NOT use with fluids with a flashpoint below 100°F such as gasoline and alcohol.
6. **DO NOT REMOVE PC BOARD.**
Damage to LCD could occur, and warranty is void.

GENERAL DESCRIPTION

The Sotera 825 & 850 Meters are nutating disk, positive displacement meters that use magnetic coupling to convert fluid flow into digital display information. The meter can store and display the current flow amount (current total), or cumulative flow amount (totalizer) in any of five user specified units (ounces, pints, quarts, liters, and gallons) or special units (e.g. per acre volume). The meter can be calibrated without dispensing fluid simply by selecting a calibration factor from the 20 stored settings. Power is supplied by two AA field replaceable batteries.

TECHNICAL INFORMATION

Flow Ports: 1" NPT inlet/outlet ports, female threads
Flow Range: 2 to 20 U.S. GPM / 7.6 to 75.7 LPM
Pressure: 120 PSI / 8.2 Bars maximum at 70°F/21°C
50 psi/3.4 Bars maximum at 130°F/54°C
Temperature: Min. operating temperature = 0°F/-17°C
Max. operating temperature = 130°F/54°C
Meter can be stored at lower temperatures, but display may not work well below 0°F
Accuracy: ± 0.5%
Units of measure: Ounces, pints, quarts, liters, gallons;
special calibration option also available
Range: 9999 current total; 10,000,000 accumulated total

MATERIALS OF CONSTRUCTION:

Body: Polypropylene
Chamber: Ryton, 303 Stainless Steel
Wetted Seals: Fluorocarbon
Electronic Module Weather & Dust Seal: Buna-N
Display: LCD (Liquid Crystal Display)
Power: Two alkaline AA batteries, included

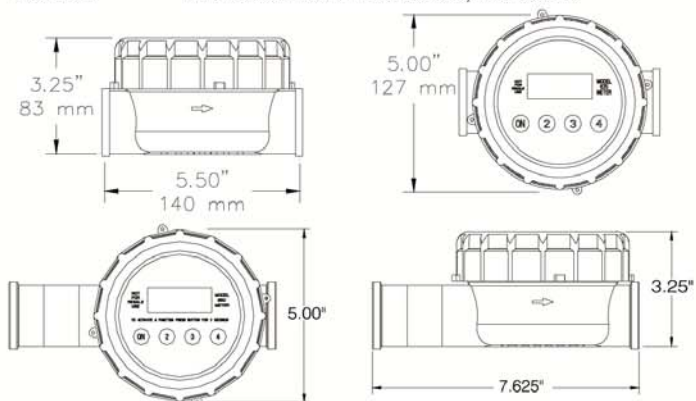

Fluid Compatibility

The 825 & 850 Digital Meters will handle most pesticides, automotive fluids (except gasoline) and mild acids. It is known to be compatible with the following fluids:

Aatrex 4L®	Guardman®
Abate 4E®	Harness Xtra®
Apron®	Karate®
Agrotain®	Laddock S-12®
Assure II®	Lasso Micro Tech®
Atrazine 4L	* Lumax™
Banvel®	Manifest™
Banvel SFG®	Marksman®
Bicep®	Maxim®
Blazer®	Methyl Parathion
Broadstrike®+Treflan®	Motor Oil
Broadstrike®+Dual®	Nufos®
* Camix™	Phosphoric Acid
Caustic Soda (50%)	Poast®
Clarity®	Poast HC®
Command®3ME	Poast Plus®
Conclude®	Princep 4L®
Conclude®Xtra	Prowl®

Contour	Prowl® 3.38EC
Detail™	Pursuit®
Diesel Fuel	Reflex®
Dividend®	Rezult®
Doubleplay®	Ridomil Gold®
Dual®	Roundup®
Dual II®	Sodium Hydroxide (50%)
Eptam 7E®	Squadron®
Ethylene Glycol	Storm®
Fallowmaster®	Surpass® 100
Flexstar®	Surpass® EC
Frontier®	Superboll®
FulTime®	Topnotch®
Furadan®	Touchdown®
Fusion®	Treflan™
Gramoxone Extra®	Treflan™ HFP
Gramoxone Inteon™	Water

* Requires EPDM Seals

Aatrex®, Aatrex® 4L, Bicep®, Bicep II®, Dual®, and Dual II® are registered trademarks of Syngenta Corporation. Broadstrike™ and Treflan™, are registered trademarks of Dow AgroSciences. Banvel®, Banvel SGF®, Blazer®, Camix™, Clarity®, Conclude®, Galaxy®, Guardsman®, Lumax™, Manifest™, Marksman®, Poast®, Poast HC®, Poast Plus®, Rezult®, and Storm® are registered trademarks of BASF. DoublePlay®, Eptam® 7E, FulTime™, Fusion®, Gramoxone® Extra, Karate®, Reflex®, Surpass®, TopNotch™, and Touchdown® are registered trademarks of Syngenta. Contour®, Detail™, Pursuit®, Prowl®, and Squadron®, are registered trademarks of American Cyanamid. Harness® Xtra, Roundup®, are registered trademarks of Monsanto Company. Command®, and Furadan® are registered trademarks of FMC. Agrotain® is a registered trademark of IMC Agrico. Superboll® is a registered trademark of Griffin.

The 825 & 850 Digital Meters are NOT compatible with very strong acids or if fluid flash point is below 100°F (38°C). If in doubt about compatibility of a specific fluid, contact supplier of fluid to check for any adverse reactions to the following wetted materials.

Polypropylene Body	Stainless Steel Screws/Shaft
Fluorocarbon Seals	Ryton Chamber

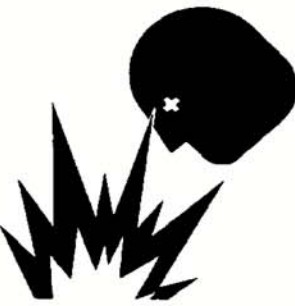

⚠ DANGER

Not for use with fluids that have a flash point below 100°F (37.8°C, ie: gasoline, alcohol). Refer to NFPA 325M (Fire Hazard Properties of Flammable Liquids, Gases, and Volatile Solids) for flash points of common liquids. Static electricity buildup and discharge could result in arc and explosion.

OPTIONS

- EPDM Seals
- 1 5/16" SAE threaded ports

INSTALLATION

Use Teflon tape or thread compound on all threaded joints.

1. Determine direction for fluid flow and point arrow on meter body in that direction.
2. Thread hose or pipe into ports until snug. Be careful not to cross thread when starting threads.

INSTALLATION HINT

To prevent cross threading, turn the pipe/hose backwards (counterclockwise) until you feel it engage threads, then tighten.

Changing Meter Readout Position

If it is necessary to change position of the meter readout, follow these steps (Refer to exploded view).

1. Unscrew meter cap (item 1). Use a strap type oil filter wrench if too tight to unscrew by hand.
2. Insert a wide, flat-head screwdriver into the upper slot and gently pry up electronics module (see Figure 1).

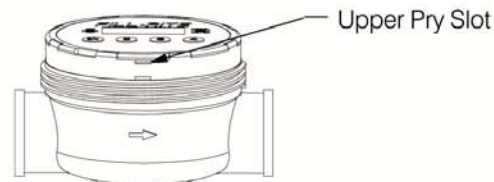

Figure 1

3. Gently rotate electronics module to desired location.

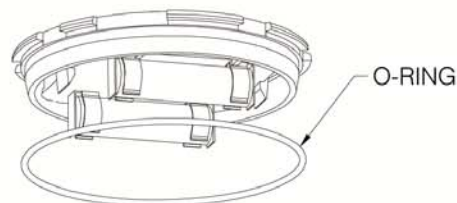

Figure 2

5. Press electronics module down into meter cover in the correct orientation.
6. Thread on meter cap until hand tight. To check tightness, there should be 1/8" gap between cap and ridge on outlet port. (See Figure 3).

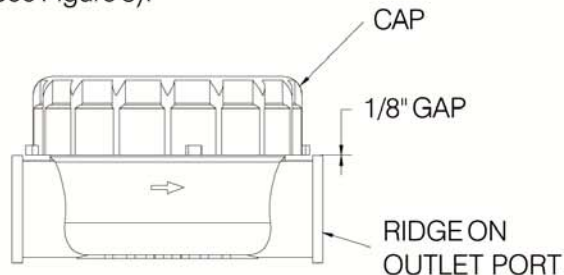

Figure 3

OPERATIONAL FUNCTIONS



- Turns meter on when off.
- Displays accumulated total as long as it is held on. If accumulated total is larger than 9999, the numbers will scroll across the screen.



- When held for 1 second, it resets current total to zero. Also resets to normal operating mode when in CAL or FLSH mode.



- When held for 3 seconds, it allows changes to the calibration factor displayed in the bottom left corner. Repeated activation will increment the number up to 19 and back to zero. When desired number is displayed, press button (2) to lock in the new number and return to normal operation.



- When held for 3 seconds, FLSH is displayed. Fluid dispensed will not be added to either the accumulated total or current total. Press button (2) to return to normal operation.

USE

CAUTION: Meter will count air if you dispense air. Before initial operation or when air has entered the system, prime the meter by dispensing fluid until all trapped air has been removed. Meter is now ready to operate

1. Press (ON) button to turn meter on. Current total, unit of measure, and calibration factor are displayed. The meter also turns on automatically and begins recording when fluid starts flowing through it.



2. Hold button (2) for one second to set current total to "0.00."
3. Begin dispensing.

NOTE: Meter display automatically goes blank after 60 seconds of inactivity and automatically comes back on when flow resumes. *No data is lost during periods of inactivity.*

CAUTION: Wear proper safety equipment when handling hazardous fluids.

CALIBRATION USING THE "CAL" FACTOR

The thinner the fluid, the lower the CAL number.
The thicker the fluid, the higher the CAL number.

- CAL 4 is set for thin fluids like water.
- CAL 19, the highest number, is set for very thick fluids like cold molasses.
- Each number changes the meter accuracy by about 1%.

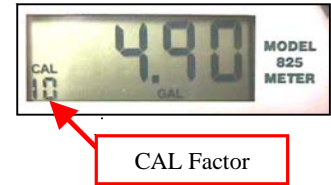

Table #1: Suggested CAL Factor settings for Common Fluids

0	1	2	3	4	5	6	7	8	9	10	11	12	13	14	15	16	17	18	19
				Water		Kerosene		GRAMOXONE INTEON™ @ 50°F		Anti-Freeze @ 70°F		ROUNDUP® @ 50°F TREFLAN™ @ 50°F	ATRAZINE 4L @ 50°F	10 wt Oil @ 70°F	DUAL® @ 50°F		BICEP® @ 50°F		Molasses @ 32°F

Note: The suggested CAL factors are for REFERENCE ONLY.

"1-STEP" CALIBRATION PROCEDURE

A) Set CAL factor to 10



- Hold button ③ for three seconds. Press ③ again until the number "10" shows below CAL (Note: If you go past 10, keep pressing ③ because the number returns to 0 after 19).

Press ② to get back to normal operating mode.

Note: If your fluid is listed on Table 1, use that number in step (A) above in place of 10.

B) Prime Pump and meter by dispensing 2-3 gal of fluid back into the bulk tank.



- With outlet valve closed and pump still running, reset meter to 0.00.

C) Fill Proving Can exactly to the 5.0 gallon line.



Focus on the Proving Can, do not look at the meter at this point.

(While filling Proving can, keep the hose end nozzle wide open as long as possible for best accuracy).

D) Adjust Meter CAL Factor.



- If meter reads high, increase the CAL factor. Each CAL # changes the accuracy by about 1%. For a 5 gallon proving can, 1% = 0.05 gallons.

- If 5.10 is displayed, this is 2% over 5.00; thus, change CAL to 12.



- Press ② to return to normal mode and to reset to 0.00 Meter is now ready.



- On the other hand, if the meter reads low, lower the CAL factor. If 4.90 is displayed, it is 2% less than 5.00, so this meter should be set on CAL 8.

CHANGING THE CAL FACTOR

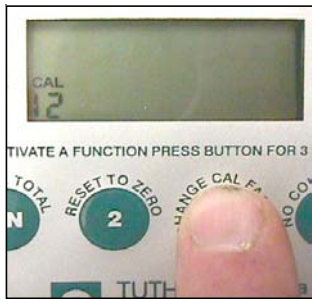

- Hold button ③ until the display only shows CAL and number.
- Press ③ repeatedly until you reach the desired number. Note – number will increment up to 19, then back to zero.
- Press ② to return to normal operating mode.

BATTERIES

■ **NOTE:** Low battery icon will flash when batteries begin to lose power. Meter still functions properly for several days after the icon begins to flash. Neither calibration, current total or totalizer quantities will be lost when replacing batteries.

To Replace Batteries (refer to exploded view)

1. Unscrew meter cap (item 1). Use a strap type oil filter wrench or large 5" jaw pipe wrench if needed.
2. Insert a flat-head screw driver into the top slot (see Figure 4) and gently pry up electronics module.

CAUTION: Be careful not to get fluid or dirt in electronics area.

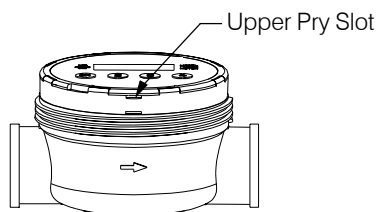

Figure 4

3. Remove old batteries and insert new batteries, making sure battery polarity is correct, or meter damage could occur.
4. As noted in Figure 5, reinstall o-ring on electronics module. Align sensor receptacle in proper location. Press module gently down into meter cover.

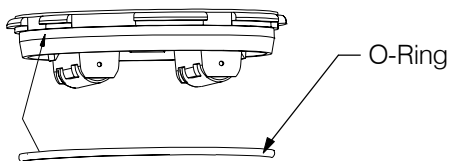

Figure 5

5. Thread on meter cap until hand tight. To check tightness, there should be 1/8" gap between cap and ridge on outlet port. (See Figure 6).

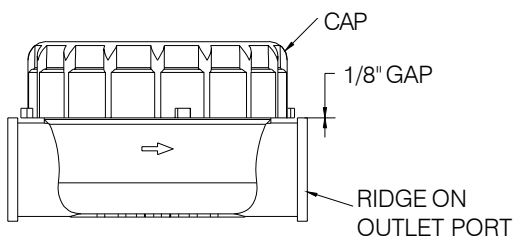

Figure 6

REPAIR

If any meter components are damaged, they should be replaced. See meter drawing and parts list for correct replacement part number before ordering.

MAINTENANCE



CAUTION

Follow fluid manufacturer's recommended procedures for handling and disposing of metered fluids.

Meter should be flushed between uses with water to prevent chemicals from drying and plugging meter.

Thorough Cleaning (refer to exploded view)

If meter is plugged due to hardened chemical or debris, do the following:

1. Drain all fluid from meter.
2. Unscrew meter cap (item 1). Use a strap type oil filter wrench or large 5" jaw pipe wrench if necessary.
3. Insert a flat-head screwdriver in the lower slot (see Figure 7) and turn to pry up meter cover (item 6).

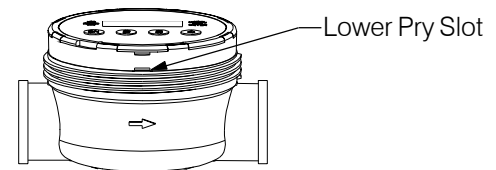

Figure 7

4. The meter chamber (item 8) can now be removed.
5. Rinse all meter components with flushing fluid. Do NOT submerge display assembly. Be careful not to get any fluid or dirt in the electronics module.
6. Reassemble meter.

CALIBRATION NOTE: Over time, the chamber inside the 825 meter will wear, requiring the meter to be recalibrated with water. When this should be done depends on the amount and type of fluid dispensed. In most crop protection fluid uses (less than 1000 gallons of a clean fluid per year), the 825 meter will remain accurate for many years without recalibration. On the other hand, dispensing an abrasive fluid may require more frequent recalibration.

The 825 meter is designed to be calibrated with clean water for safe handling. See "Water Calibration" section in Appendix-B.

Storage

Store in a cool, dry place. Drain out all fluid that could freeze in the meter.

TROUBLESHOOTING GUIDE

PROBLEM	POSSIBLE CAUSE	SOLUTION	NOTES
Meter won't turn on	<ul style="list-style-type: none"> •Dead batteries •Damaged or contaminated electronics module 	<ul style="list-style-type: none"> •Replace batteries. •Replace electronics module & gaskets. 	Seal to electronic chamber is broken if display label is removed or punctured.
Flashing decimal	<ul style="list-style-type: none"> •Current total has rolled over 	<ul style="list-style-type: none"> •Reset display to zero by pressing button ② 	Meter will continue to operate normally.
Flashing or dim display	<ul style="list-style-type: none"> •Low batteries 	<ul style="list-style-type: none"> •Replace batteries. 	Use alkaline batteries.
Leaking fluid at inlet/outlet port	<ul style="list-style-type: none"> •Need thread sealant •Cross-threaded port 	<ul style="list-style-type: none"> •Add Teflon pipe tape to joint. •Replace body 	
Fluid flows; meter won't count	<ul style="list-style-type: none"> •Meter disk sticking •Damaged driver or magnet •Meter failure 	<ul style="list-style-type: none"> •Clean out meter chamber. •Repair or replace chamber assembly. •Repair or replace meter. 	
Meter reads high	<ul style="list-style-type: none"> •Air in system •Wrong calibration factor 	<ul style="list-style-type: none"> •Prime system, fix suction leak at pump. •Use a higher calibration factor. See 1-Step procedure •See "Check Meter" in Appendix-A 	Meter will count air. Chemical formulations sometimes change.
Meter reads low by 10% or less	<ul style="list-style-type: none"> •Wrong calibration factor 	<ul style="list-style-type: none"> •Use a lower calibration factor. •See 1-Step procedure. 	Chemical formulations sometimes change. Temperature also affects accuracy.
Meter reads low by more than 10%	<ul style="list-style-type: none"> •Meter chamber is worn •Chamber is partially plugged •Damaged or very worn chamber 	<ul style="list-style-type: none"> •Recalibrate meter with water. See Appendix-B. See "Check Meter" in Appendix-A. •Clean chamber •Replace chamber and recalibrate meter. 	
Meter is not consistent	<ul style="list-style-type: none"> •Air in system •Particulates in fluid •Meter has worn or damaged chamber 	<ul style="list-style-type: none"> •Prime system, fix suction leak at pump. •Put screen in front of meter. •Clean chamber •Replace chamber. 	40 mesh minimum.
Err0	<ul style="list-style-type: none"> •Calibration error •Damaged chamber 	<ul style="list-style-type: none"> •Recalibrate meter with more accurate container. •Replace chamber. 	Indicates fluid calibration is out of acceptable window. Volumetric container may be off, there may be air in the system, or the meter chamber may be damaged.
Err1	<ul style="list-style-type: none"> •Damaged electronics •Software fault 	<ul style="list-style-type: none"> •Repair or replace electronics. •Press ② then recalibrate meter 	Contact factory.
Err2	<ul style="list-style-type: none"> •Bad eeprom 	<ul style="list-style-type: none"> •Replace electronics 	Meter still functions, but all data will be lost if batteries are removed.

825 / 850 METER PARTS LIST

ITM. NO.	PART NO.	DESCRIPTION	QTY.
1	820F1537	Meter Cap	1
3	820F1558	Display Label	1
4	820F1653	Electronic Module	1
5	800G7389	O-Ring, Buna-N, 96.5mm ID (Black)	1
6	820F1534	Meter Cover	1
7	820F1552	O-Ring, Fluorocarbon (2-240) (Brown)	1
8	825F1578	Meter Chamber Assembly (Includes items 10-20)	1
9	820F1535	Meter Body (825 Meter)	1
9	850G7807	Meter Body (850 Meter)	1

825F1582, 825 METER REPAIR KIT

ITM. NO.	PART NO.	DESCRIPTION	QTY.
5	800G7389	O-Ring, Buna-N, 96.5mm ID (Black)	1
7	820F1552	O-Ring, Fluorocarbon (2-240) (Brown)	1
8	825F1578	Meter Chamber Assembly (Includes items 10-20)	1

825F1578, METER CHAMBER ASSEMBLY

ITM. NO.	PART NO.	DESCRIPTION	QTY.
10	825F1577	Magnet Holder	1
11	800F4439	Screw, #6-20 x 1/2 Phillips	2
12	800F3955	Pinion Plate	1
13	800F3965	Pinion Shaft	1
14	800G1304	G1304 Driver	1
15	35F6588	O-Ring (2-117)	1
16	820F1550	Seal Gland	1
17	800F3951	Meter Chamber Top	1
18	800G2530	Meter Disc	1
19	800F3952	Meter Chamber Bottom	1
20	800F3980	Washer	2

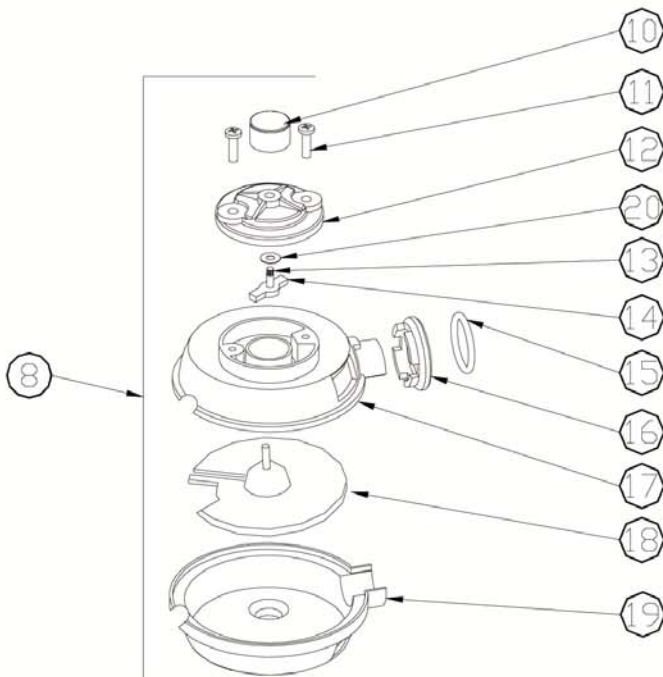
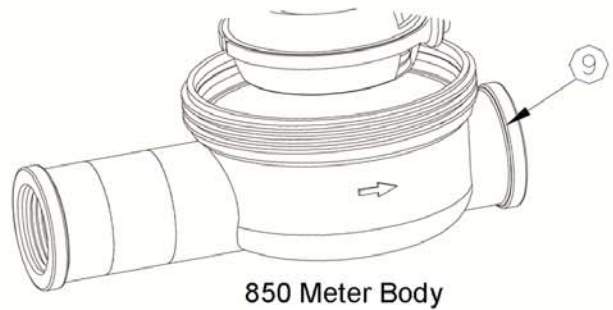
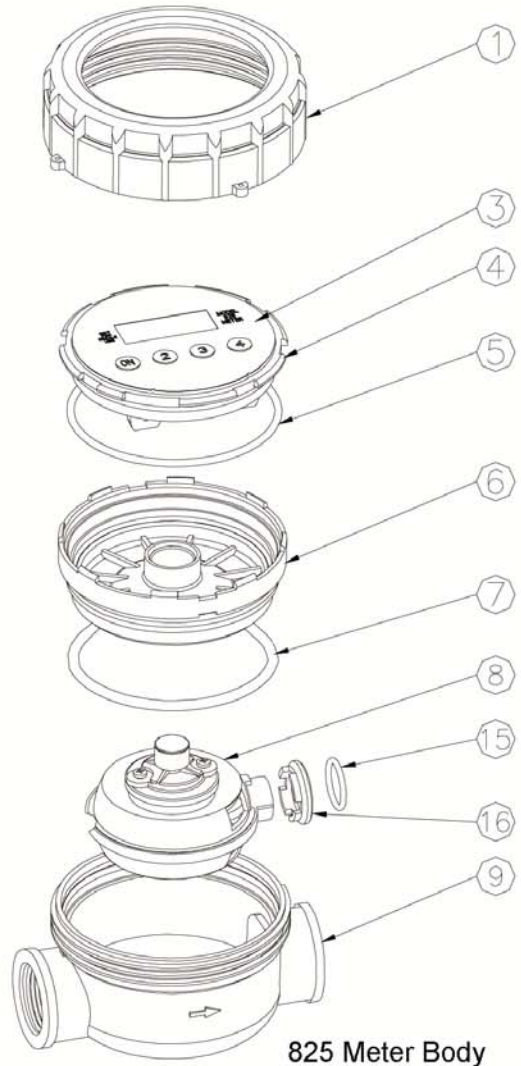

WHEN ORDERING REPAIR PARTS, BE SURE TO GIVE REPLACEMENT PART NUMBER, DATE OF MANUFACTURE AND METER SERIES NUMBER. THIS WILL ENSURE THAT THE CORRECT REPLACEMENT PART IS SUPPLIED.

**TOLL FREE CUSTOMER CARE NUMBER
800 796 0614**

APPENDIX-A

TO CHANGE UNITS OF MEASURE

The units of measure can be changed to ounces (OZ), pints (PT), quarts (QT), gallons (GAL), or liters (LITER) without recalibrating the meter. If special units are desired, see note below.

1. Hold buttons (2) and (4) for three seconds. Display will read "7r1.02".
2. Press button (3). Display will show the current units.
3. To change units, press the ON button repeatedly until the desired unit is displayed.
4. Press button (2). Display will read "7r1.02".
5. To return to normal operating mode press button (2) again. The units selected will be displayed. Current or accumulated total will be changed to reflect the new units.

Special Units

To use special units, you need to know how many ounces are in your special unit. *Here is an example: You want to use "acres" as your "special" unit. The fluid is to be applied at 18 ounces per acre.* These are the additional steps to set the meter to "special" units (ignore steps 4 & 5 above):

- a. After selecting "special" in step #3 above, press button (2).
- b. Enter the number of ounces in a special unit by pressing button (4) to increment the digit, and the (ON) button to move the flashing digit to the right. If you make a mistake, press button (2) to start back at the left most digit. *Per our example, we would enter 018.0.*
- c. Press the (ON) button again. Display will read "7r1.02".
- d. To get back to the normal operating mode, press button (2).

RESET ACCUMULATED TOTAL

1. Press (2) and (4) at the same time and hold for 3 seconds.

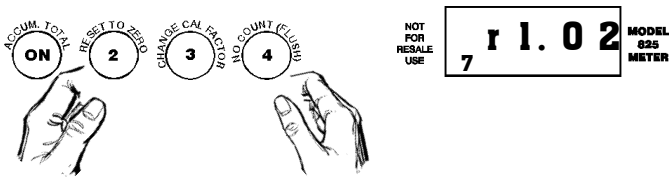

Display will read the version of the software loaded in the meter (example: "7 r1.02").

2. Press (ON) to display accumulated total. If over 9999, display will scroll across the screen

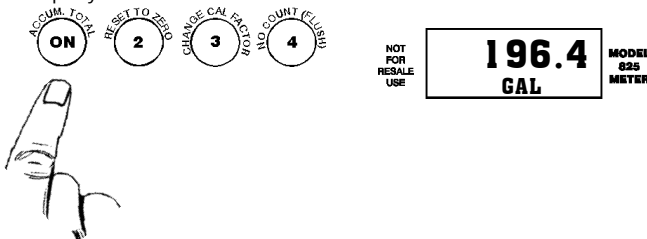

3. Hold buttons (ON) and (4) for 5 seconds to reset accumulated total.

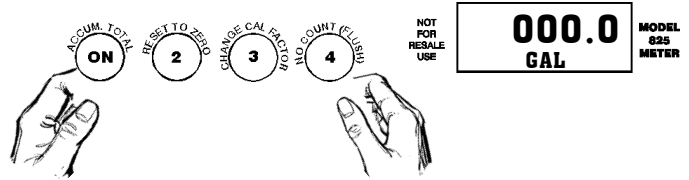

4. Press button (2) twice to get back to normal operating mode.

METER CHECK

You can check the calibration in your meter.

1. Set to CAL 4 (See "to change the calibration factor").
2. Hold button (4) for 3 seconds. Meter will display "FLSH".
3. Hold buttons (ON) & (3) together. A number will display that indicates the pulses per unit used to calculate flow (ie: pulses per gallon). When new, this number is between 120.0-127.0 pulses per gallon.

*If you find a number higher than 127, recalibrate with water (see Appendix-B). If this number is lower than 120, the meter chamber may need to be replaced.

4. Press (2) to get back to normal operating mode.

FLSH (FLUSH) MODE

The 825 Meter can be flushed without adding to the totalizer. Turn meter on by pressing the (ON) button. Press (4) and hold for 3 seconds. Display will show FLSH. Flush meter with suitable fluid (water is suitable for most herbicides). When completed, press (2) to leave FLSH mode and return to normal operation. Quantity of fluid flushed will not be added to total.

CAUTION: Do not leave meter in FLSH mode. Batteries will completely drain within 20 days if left in FLSH mode.

APPENDIX-B

Water Calibration

The 825 meter is designed to be recalibrated with water for safe handling. Over time, the chamber inside the meter will wear. Recalibrating the meter with clean water will insure that Table #1 is most accurate.

You will need a container of known volume, at least 5 gallons or larger. Do not exceed a 60 gallon container.

1. Press the (2) & (4) buttons at the same time and hold for 3 seconds.

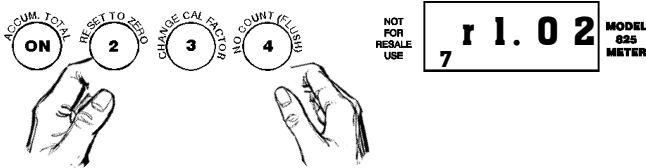

The display will read the version of the software loaded in the meter (example: "7r1.02").

2. Press button (3) to enter calibration mode.

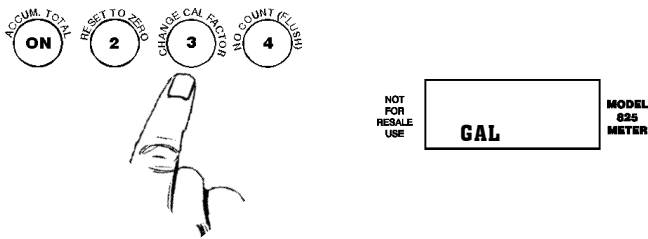

The unit of measure will be displayed.

3. Press button (3).

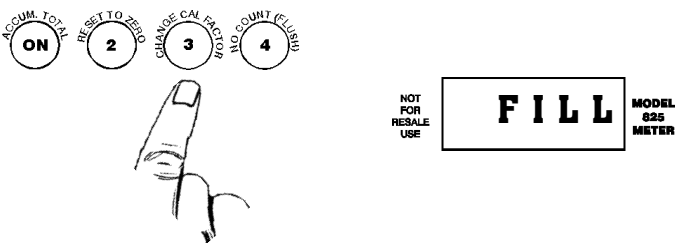

The display will read "FILL".

4. Now dispense water into your container. "FILL" will flash on the display.

5. After dispensing, press the (ON) button.

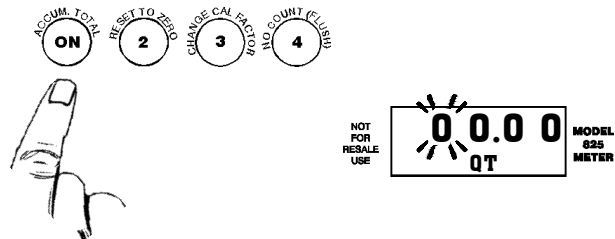

The left digit of the display will blink.

6. Press the (4) button to increment the digit to the amount of fluid dispensed (example: 05.00). Press the (ON) button to move to the right.



Move to Right Increment No.

If you make a mistake, press button (2) to start back at the left-most digit.

7. After number is loaded, press the (ON) button again to accept.

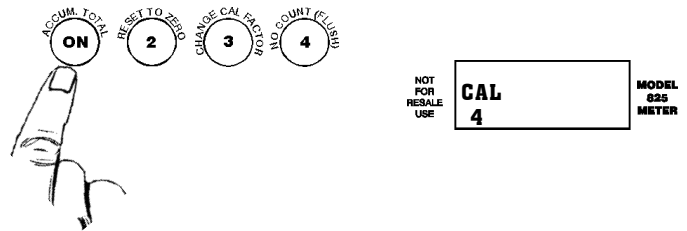

8. Display now shows CAL 4.

Since you are calibrating with water, accept this by pressing the (ON) button again. If calibrating with a fluid other than water, see Appendix-C. Display will again show "7r1.02".

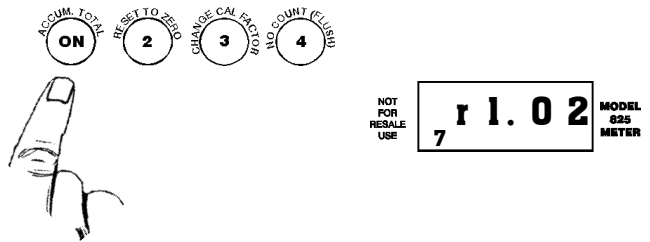

Note: If the value entered is out of an acceptable range, the display will read "Err0" and the meter will revert to the previous settings. See Troubleshooting Guide for more information.

9. Press (2) to get back to the normal operating mode.

APPENDIX-C

Fluid Calibration (other than water)

CAUTION: DON'T DO THIS unless you understand fully how CAL factors work.

CAUTION: Calibrating with a fluid other than water voids Table #1. After calibration, set the meter to CAL 4, and use the meter on CAL 4 (unless you input a different number during step 9 below).

You will need a container of known volume, at least 5 gallons or larger. Do not exceed a 60 gallon container.

1. Press the (2) & (4) buttons at the same time and hold for 3 seconds.

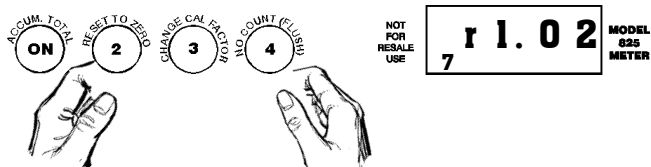

The display will read the version of the software loaded in the meter (example: "7r1.02").

2. Press button (3) to enter calibration mode.

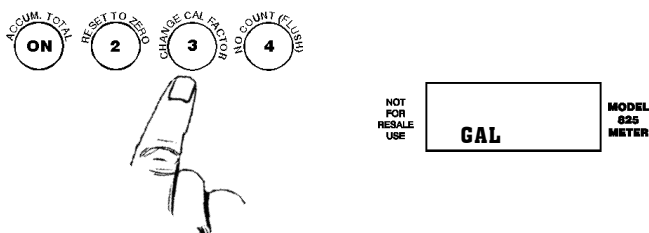

The unit of measure will be displayed.

3. Press the (ON) button to change unit of measure, if required.

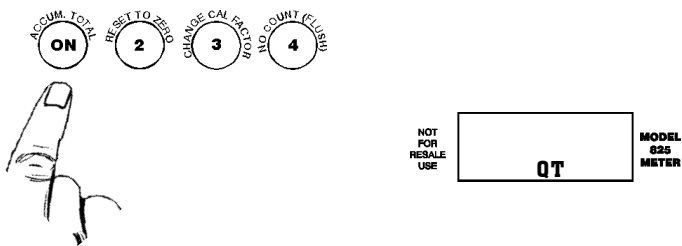

4. Press button (3).

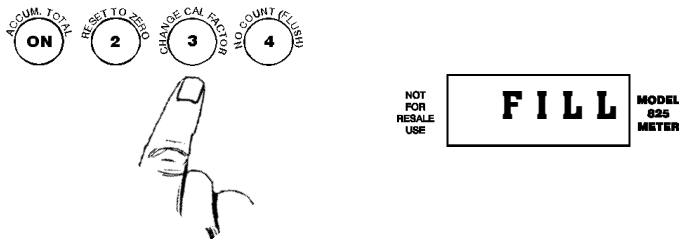

The display will read "FILL".

5. Now dispense fluid into your container. "FILL" will flash on the display. For best results, dispense fluid at the same flow rate that will be used in actual use.
6. After dispensing, press the (ON) button.

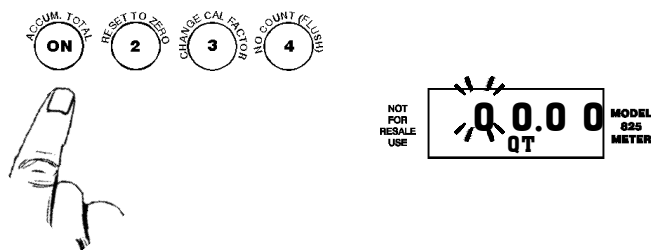

The left digit of the display will blink.

7. Press the (4) button to increment the digit to the amount of fluid dispensed (example: 05.00). Press the (ON) button to move to the right.

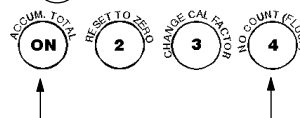

Move to Right

Increment No.

If you make a mistake, press button (2) to start back at the left- most digit.

8. After number is loaded, press the (ON) button again to accept.

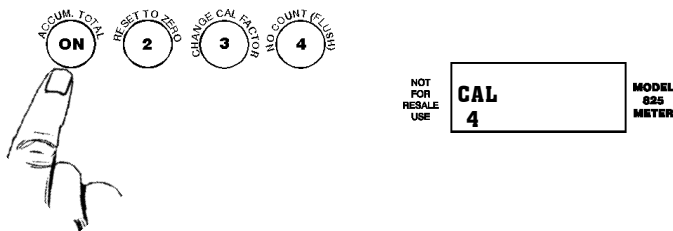

9. Display now shows CAL 4. This is the default for water. Check Table 1 for your fluid. Press (3) to change the Cal #. Press (ON) to accept. Display will again Show "7r1.02".



Note: IF YOU ACCEPT CAL 4, USE THE METER ON CAL 4 WHEN DISPENSING THIS FLUID.

Note: If the value entered is out of an acceptable range, the display will read "Err0" and the meter will revert to the previous settings. See Troubleshooting Guide for more information.

10. Press (2) to get back to the normal operating mode.

APPENDIX-D

METER CALIBRATION FACTOR SELECTION BASED ON FLUID VISCOSITY

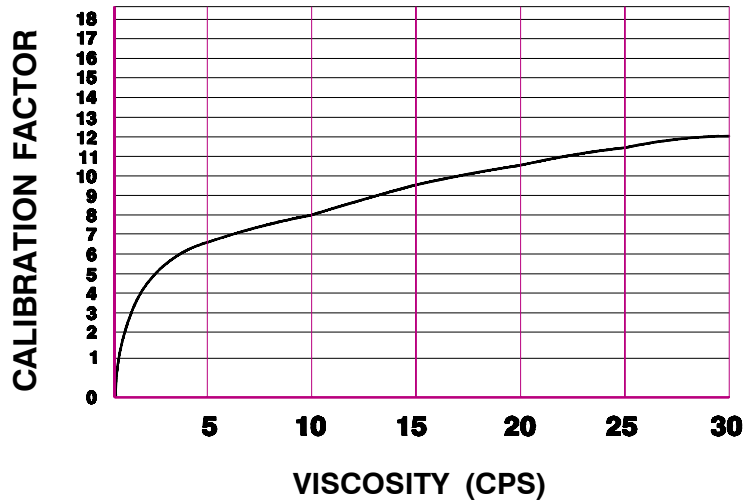

**Low
Viscosity
(thin)
Fluids**

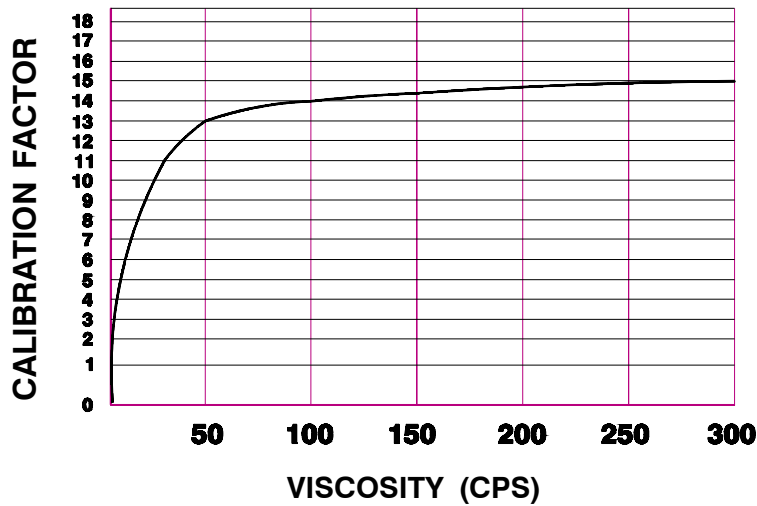

**Medium
Viscosity
Fluids**

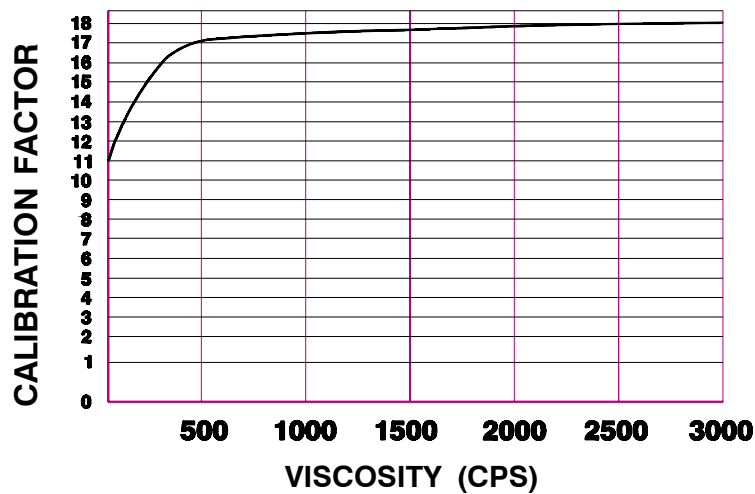

**High
Viscosity
(very thick)
Fluids**

NOTE: Graphs are accurate with original factory calibration, or a water calibration. See page 8.