

Note: If the pump is dismantled during the warranty period, the pump is no longer under warranty.

Dismantling:

1. Tools required for dismantling the PAH 10 - 12.5 pump.

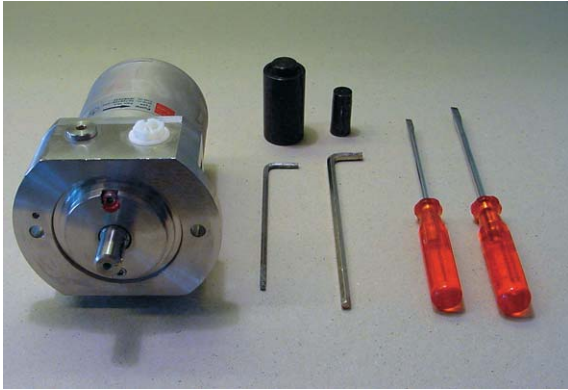

2. Remove the parallel key and unscrew the front cover.

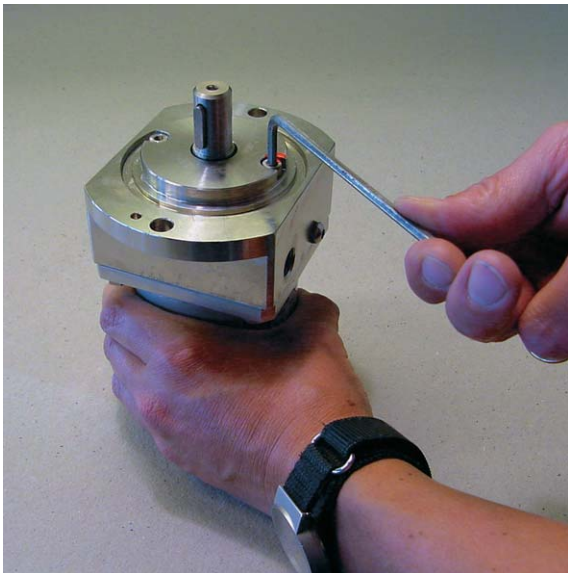

3. Dismantle the front cover using a vice.

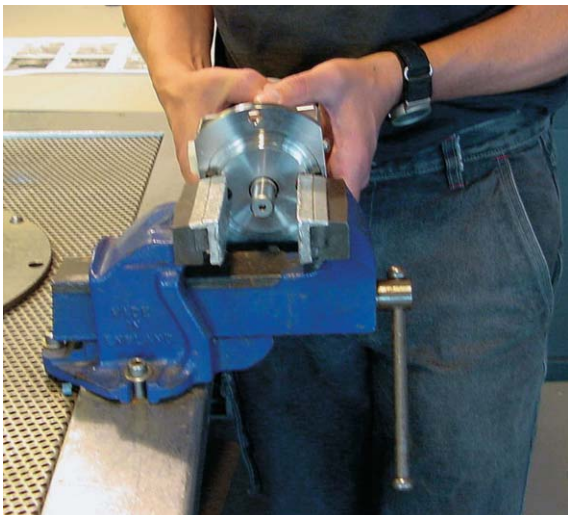

4. Remove the shaft seal using two screwdrivers.



5. Remove the two small O-rings from the flange. Remove the seal from the front cover using a screwdriver.

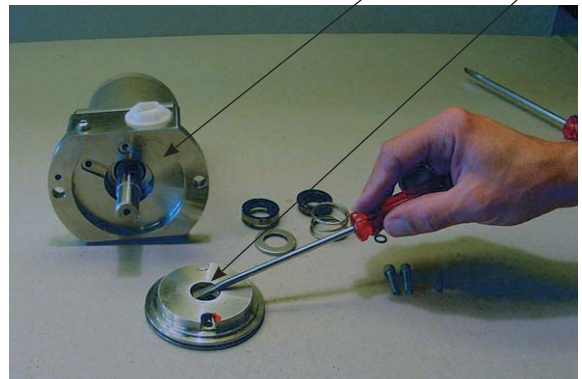

6. Unscrew the four screws for the housing.



7. Remove the housing.



8. Remove the cylinder barrel.



9. Remove the pistons and the retaining plate from the cylinder barrel.



10. Remove the retaining guide.



11. Remove the spring guide.



12. Remove the spring.



13. Loosen the thrust plate using two screwdrivers. Place one of the screwdrivers in the slot of the thrust plate.



14. Remove the thrust plate.



15. Remove the five O-rings and the five back-up O-rings.



16. Remove the port plate from the flange.

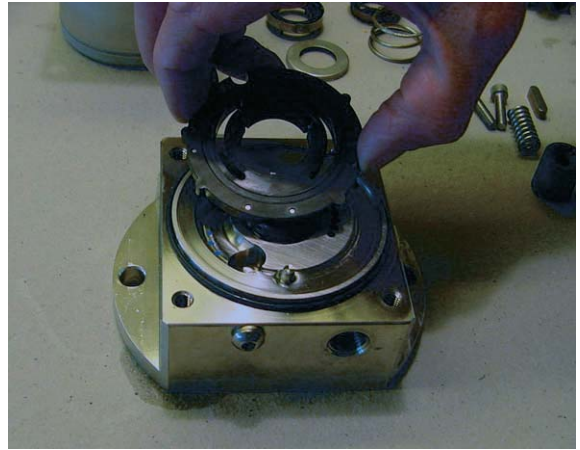

17. Wash all parts and replace all seals (inclusive shaft seal).

18. Inspect all parts carefully (see "Inspection") and replace any worn parts.

19. If the pump has failed, the reason for the failure must be found and fixed before the repaired pump is re-installed.

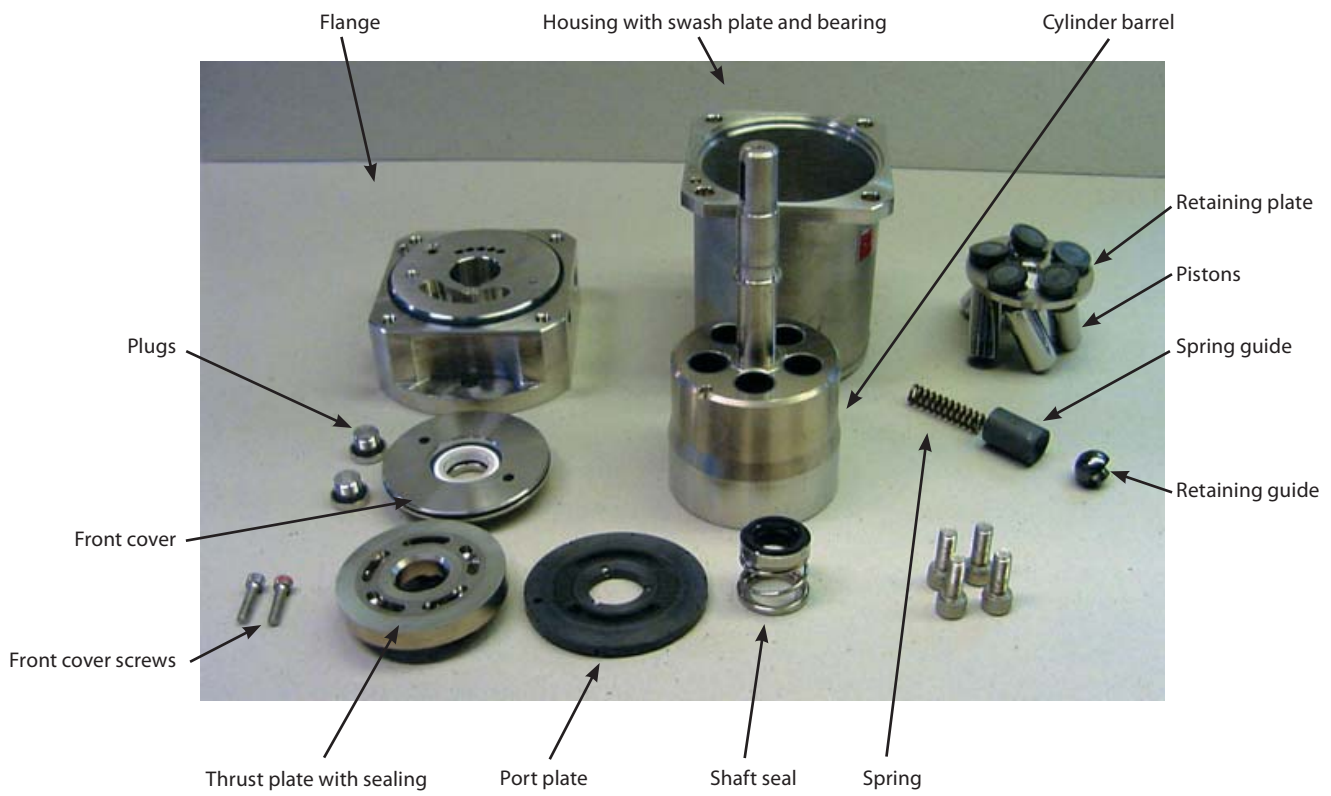

Inspection:

Port plate and thrust plate

1. Neither port plate nor thrust plate must show any sign of wear.

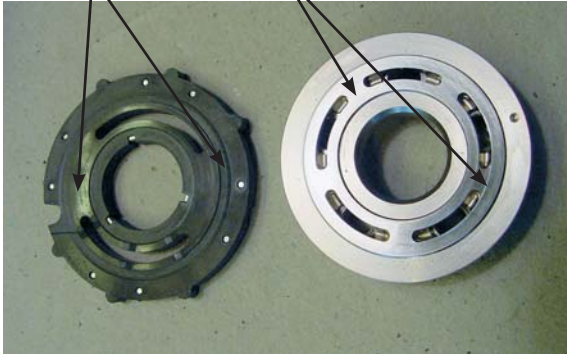

2. Hold a ruler against the surface of the plates and check the tightness against a light source.



3. Check that both O-rings and back-up rings are not broken and do not show severe wear.

Pistons

1. The play in the ball and socket joint must not exceed 0.1 mm.
2. The thickness of the piston shoes must be at least 4.1 mm.

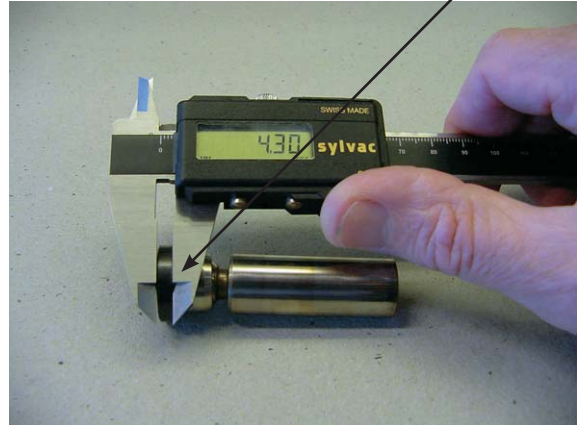

3. Hold a ruler against the surfaces of the piston shoes to check that the surfaces are even and smooth and without any scratches.



4. Pumps for technical water only:

It is acceptable that the (black) treated surfaces of the pistons are partly worn off.

Cylinder barrel:

1. Check the outer bearing surface for large wear grooves (not critical).
2. Check that the bushings are free from seizure and large scratches.

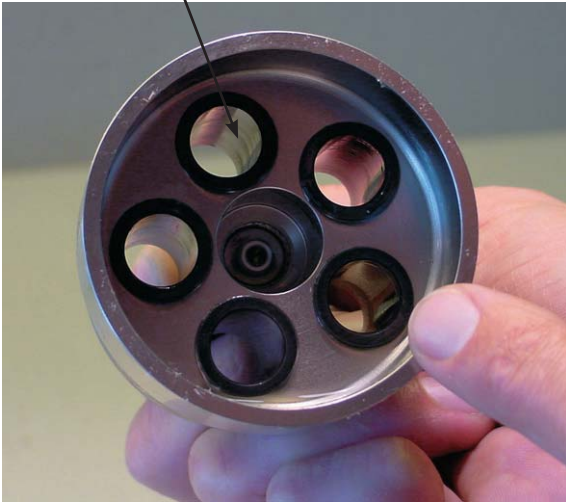

3. Ensure that the pistons can move freely in the bushings.

Housing:

1. Check that the swash plate surface is smooth and without any big scratches (depth more than 0.1 mm).

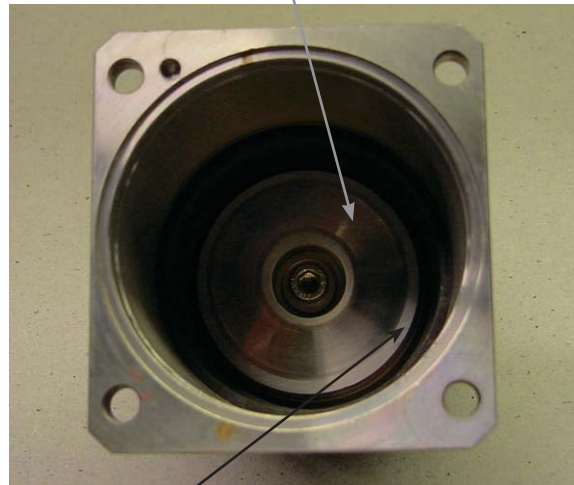

2. Check the bearing (the black part) for large wear grooves (not critical).

Assembly:

1. Parts and tools required for assembly.



2. Check that all parts are OK. Replace all seals.
3. Mount the O-ring on the flange.

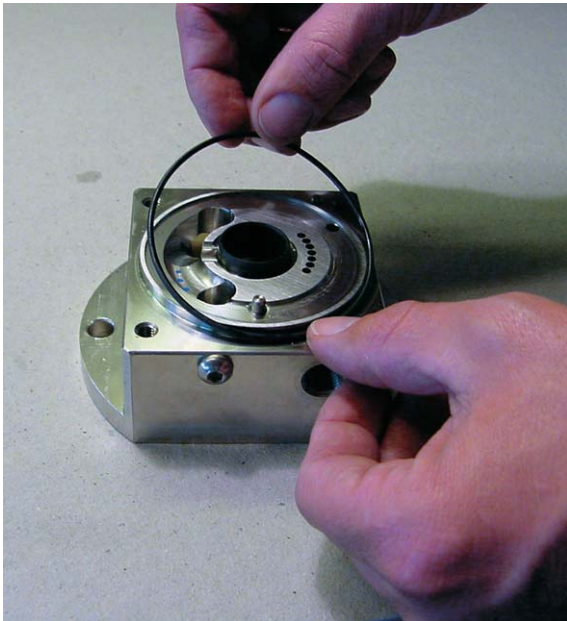

4. Mount the port plate in its right position using the pin as guide.



Guide pin

5. Mount the thrust plate with seals on the cylinder barrel.



6. Press the thrust plate into the cylinder barrel using a piece of plastic.



7. Check that the gap between the cylinder barrel and the thrust plate is 1.5-2.5 mm.



8. Mount the cylinder barrel in the flange.



9. Mount the spring in the centre hole.



10. Mount the spring guide.



11. Mount the retainer guide on the spring guide.



12. Mount the retaining plate on the retainer guide. Ensure that the bended surface points downwards.



13. Insert the pistons.



14. All pistons inserted.



15. Mount the pump housing using the pin as guide.

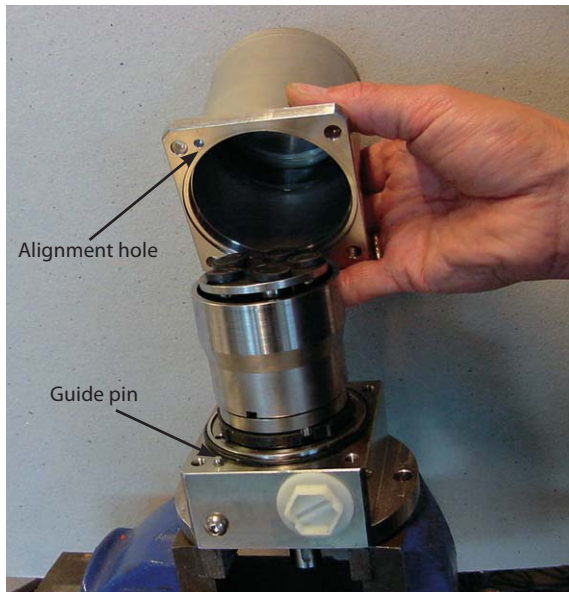

16. Press the housing down by hand and insert the screws.



17. Tighten the screws to a torque of 22 Nm.

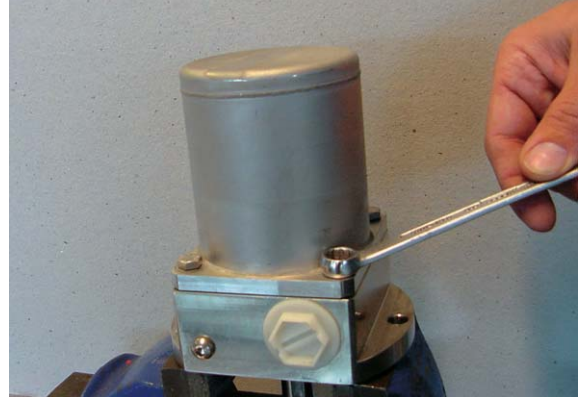

18. Mount the two O-rings in the flange and the O-ring on the front cover.



19. Wet the shaft seal with water and mount it in the front cover. Ensure that it is pressed to the bottom.

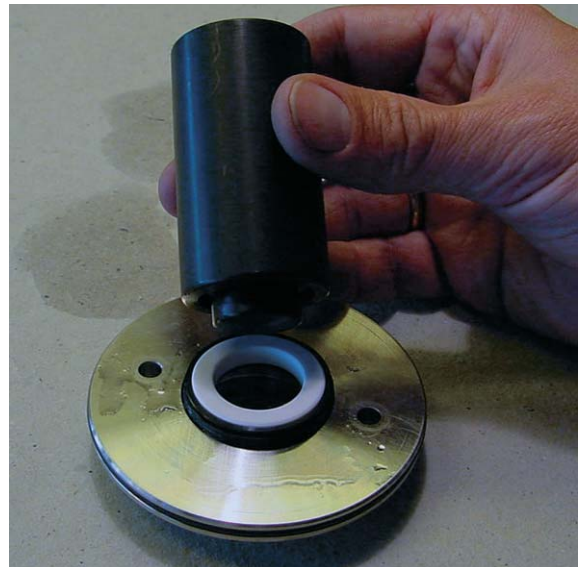

20. Mount the washer with the edge pointing upwards.



21. Mount the spring.



22. Fit the hollow bush onto the shaft.



23. Wet the shaft seal and slide it over the bush.



24. Use the shaft seal tool when pressing the shaft seal downwards.



25. Press the shaft seal in position.



23. Remove the bush.



24. Mount the front cover and align it to the screw holes.



25. Tighten the screws to a torque of 7 Nm.

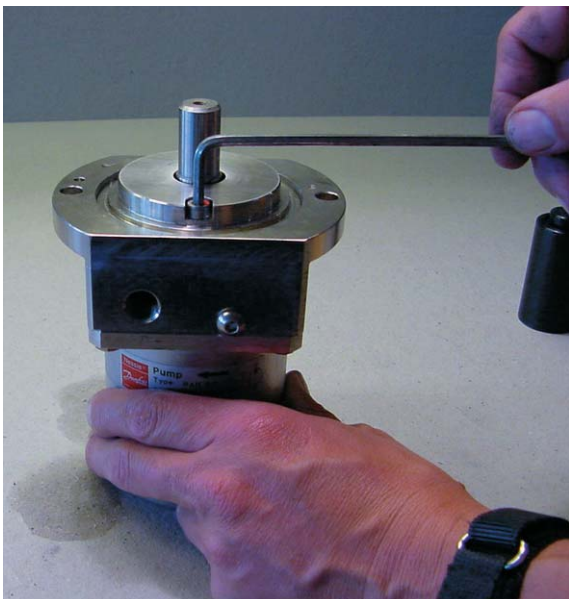

Service kit list for PAH 10 - 12.5

Pos.	Qty.	Unit	Designation	Material									
					180B4105 - Shaft seal	180B4108 - Valve plate	180B4114 - Piston kit (PAH 10 - 12.5; standard pump)	180B4106 - Piston kit (PAH 10 - 12.5; tech. water pump)	180B4113 - Cylinder barrel; (standard pump)	180B4107 - Cylinder barrel; (tech. water pump)	180Z0235 - Shaft seal tool set		
-	1	Pc.	Shaft bush, torpedo	-									X
-	1	Pc.	Press tool for 18 mm shaft	-									X
-	1	Pc.	Mounting screw	-									X
1	1	Pc.	Housing with bearing (welded)	Stainless steel (1.4301)/PEEK									
2	1	Pc.	Swash plate	Stainless steel (1.4057)									
3	2	Pcs.	Pin (Ø5.0 x 10.0)	Stainless steel (1.4401)									
4	1	Pc.	Retaining plate	Stainless steel (1.4301)			X	X					
5	1	Pc.	Retaining ball	PEEK			X	X					
7	1	Pc.	Preload spring	Stainless steel (1.4571)			X	X					
8	1	Pc.	Cylinder barrel with bushings	Stainless steel (1.4057)/PEEK					X	X			
9	1	Pc.	Thrust plate	Stainless steel (1.4301)/(1.4057)	X								
10	1	Pc.	Port plate	Stainless steel (1.4301)/PEEK	X								
11	1	Pc.	Pin (Ø6.0 x 10.0 mm)	Stainless steel (1.4401)									
12	1	Pc.	Pin (Ø4.0 x 8.0 mm)	Stainless steel (1.4401)									
13	1	Pc.	O-ring (Ø90 x Ø2.0)	NBR	X								
14	1	Pc.	Front and port flange with bearing	Stainless steel (1.4301)/PEEK									
15	1	Pc.	Shaft seal	SIMRAX, AX15EA-018, 1.44301/C/AI203	X								
16	1	Pc.	Shaft seal cover	Stainless steel (1.4301)									
17	2	Pcs.	Screw (M5 x 20)	Stainless steel (1.4310)	X								
18	4	Pcs.	Screw (M8 x 20)	Stainless steel (1.4310)	X								
20	5	Pcs.	Back-up ring	PTFE		X							
21	5	Pcs.	O-ring (Ø13.0 x Ø2.0)	NBR		X							
22	5	Pcs.	Piston with piston shoes	Stainless steel (1.4057)/PEEK			X	X					
26	1	Pc.	Preload spring guide	PEEK			X	X					
27	1	Pc.	Key (5 x 5 x 20 mm)	Stainless steel (1.4571)	X								
28	2	Pc.	Plug (G¼" NV17/Ø20.5)	PA									
29	2	Pcs.	O-ring (Ø11.0 x Ø2.0)	NBR									
30	2	Pcs.	Bleed instruction	PE									
31	1	Pc.	Plug (G¾" NV22/Ø32)	PA									
32	1	Pc.	Plug (G¾" NV17/Ø20.5)	PA									
34	1	Pcs	O-ring (Ø75.92 x Ø1.78)	NBR	X								
35	2	Pcs	O-ring (Ø7.0 x Ø1.5)	NBR	X								
37	1	Pc.	Washer	Stainless steel (1.4301)									
38	1	Pc.	Screw (M6 x 8 mm)	Stainless steel (1.4301)									
-	1	Pc.	Service instruction (180R9095)		X	X	X	X	X	X			

Exploded view PAH 10-12.5

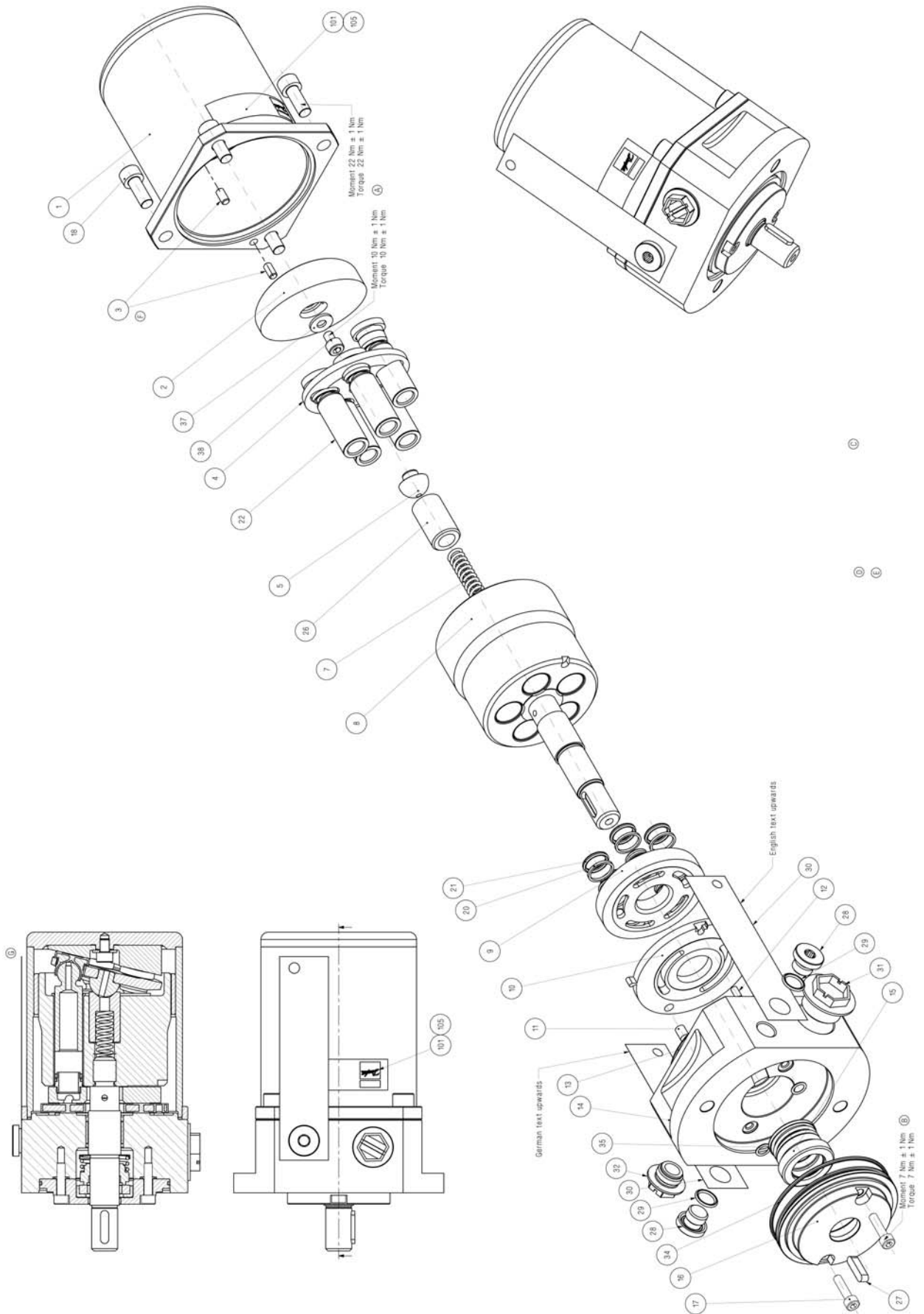

Danfoss can accept no responsibility for possible errors in catalogues, brochures and other printed material. Danfoss reserves the right to alter its products without notice. This also applies to products already on order provided that such alterations can be made without subsequential changes being necessary in specifications already agreed. All trademarks in this material are property of the respective companies. Danfoss and the Danfoss logotype are trademarks of Danfoss A/S. All rights reserved.