

4K Series - Single Stage Stainless Steel End-Suction Centrifugal Pumps Flanged

3450 RPM Models

4K111-4K253

1725 RPM Models

4K341-4K353

FEATURES

- 304SSL liquid-end construction offers corrosion resistance and increases operating life over typical cast iron models.
- Unique bulge formed components eliminates harsh radius and welds and provides greater efficiency and durability.
- Back pullout design permits easy repair of impeller and seal.
- High quality mechanical shaft seal and o-rings for a variety of standard, high temperature or chemical duty applications.
- Under casing foot mount and centerline discharge reduces misalignment and assures self-venting.
- Convenient ANSI 150# mounting flanges for secure, easy installation.
- Close coupled, motorized packages for compact and easy installation.

⚠ CAUTIONS AND WARNINGS

All High Pressure Systems require a primary pressure regulating device (i.e. regulator, unloader) and a secondary pressure relief device (i.e. pop-off valve, relief valve). Failure to install such relief devices could result in personal injury or damage to pump or property. CAT PUMPS does not assume any liability or responsibility for the operation of a customer's high pressure system.

Read all CAUTIONS and WARNINGS before commencing service or operation of any high pressure system. The CAUTIONS and WARNINGS are included in each service manual and with each Accessory Data sheet. CAUTIONS and WARNINGS can also be viewed online at www.catpumps.com/cautions-warnings or can be requested directly from CAT PUMPS.

WARRANTY

View the Limited Warranty on-line at www.catpumps.com/warranty.

SPECIFICATIONS

	U.S. Measure
Flow Range13 to 380 gpm
Pressure Range4.3 to 124 psi
10 to 285 Ft. Head
Max. Working Pressure230 psi
Min. Inlet Pressure to PrimeFlooded
RPM1725 or 3450 rpm
Inlet Fitting	4K111-4K153, 4K341-4K3532.00" ANSI
	4K161-4K251, 4K381-4K4532.50" ANSI
Discharge Fitting	4K111-4K153, 4K341-4K3531.25" ANSI
	4K161-4K213, 4K381-4K4131.50" ANSI
	4K221-4K253, 4K421-4K4532.00" ANSI
Horsepower Range	1725 RPM1 to 2 HP
	3450 RPM3 to 15 HP
Motor Options	1725 RPM, TEFC, Class F
	1.0 HP, 143 JM Frame200-230/460V, 3 PH
	1.5 HP, 145 JM Frame200-230/460V, 3 PH
	2.0 HP, 145 JM Frame200-230/460V, 3 PH
	3450 RPM, TEFC, Class F
	3.0 HP, 182 JM Frame208-230/460V, 3 PH
	5.0 HP, 184 JM Frame208-230/460V, 3 PH
	7.5 HP, 213 JM Frame208-230/460V, 3 PH
	10.0 HP, 215 JM Frame208-230/460V, 3 PH
	15.0 HP, 215 JM Frame208-230/460V, 3 PH
Cycle60 HZ
Max. Temperature*	Continuous.....160°F
Weight (Pump Only)	4K111, 4K161, 4K17123.0 lbs.
	4K121, 4K131, 4K181, 4K191,
	4K221, 4K231, 4K381, 4K42131.0 lbs.
	4K141, 4K151, 4K201, 4K211,
	4K241, 4K251, 4K341, 4K351,
	4K401, 4K411, 4K441, 4K45143.0 lbs.
Dimensions	Pump Only(see chart)

*Contact Cat Pumps for applications above 160°F.

SELECTION CHART - 1725 RPM

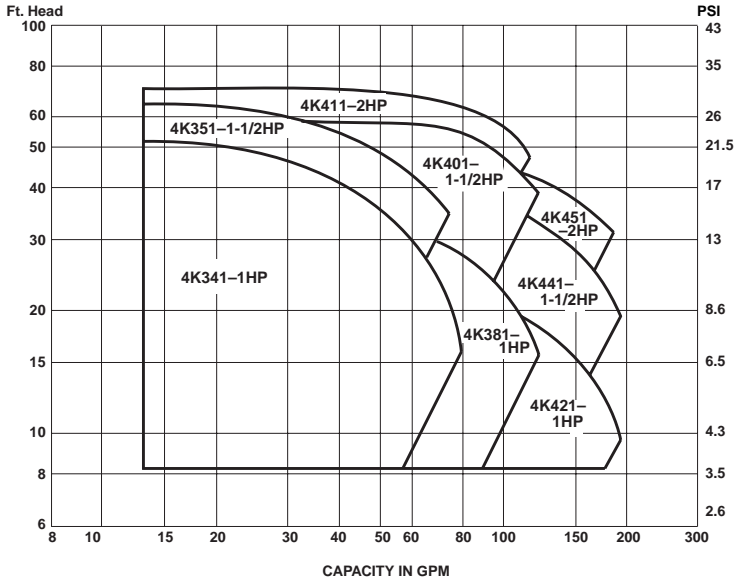

Note: See motorized pump unit codes chart to configure pump and motor.

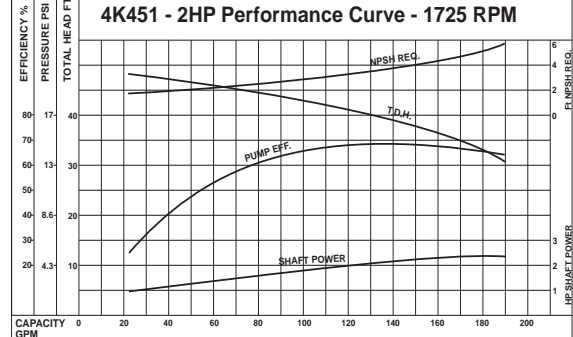
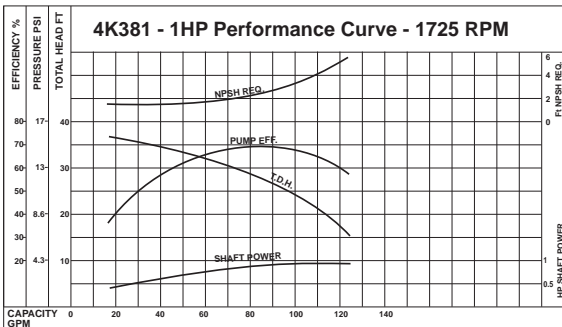
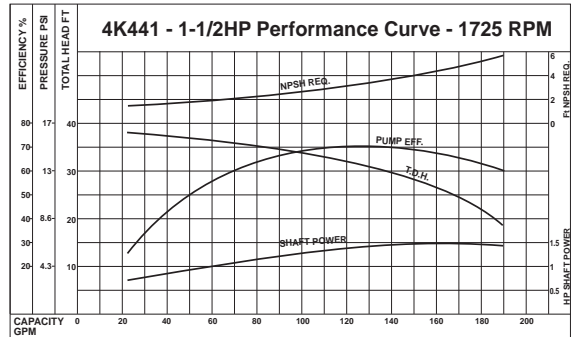
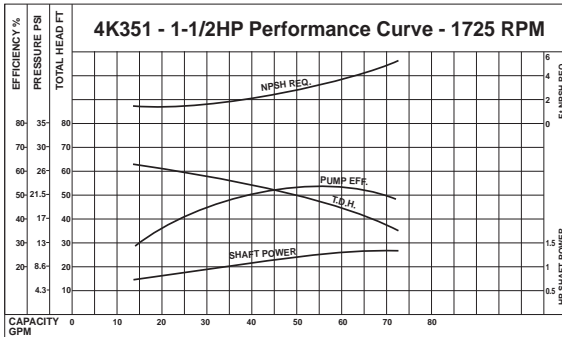
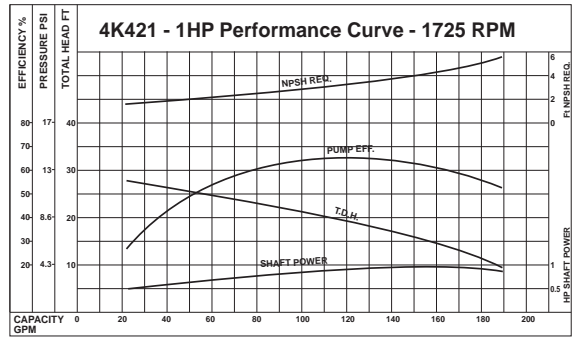
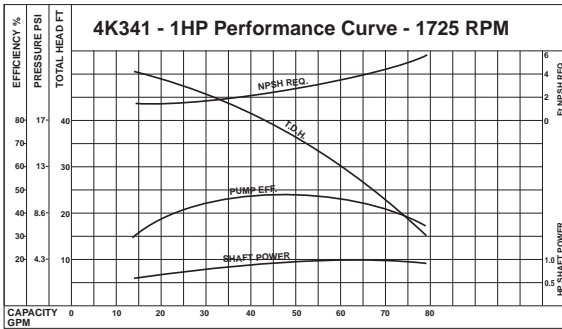
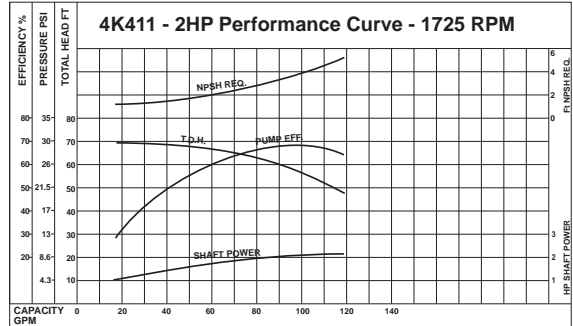
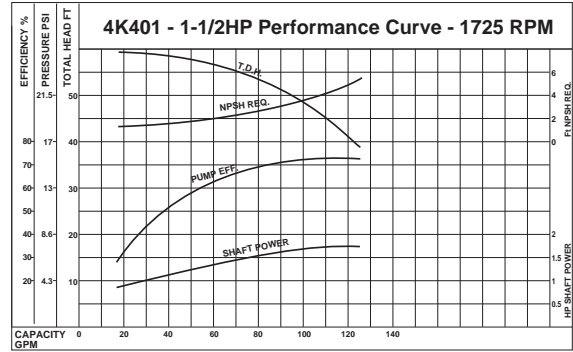

SELECTION CHART - 3450 RPM

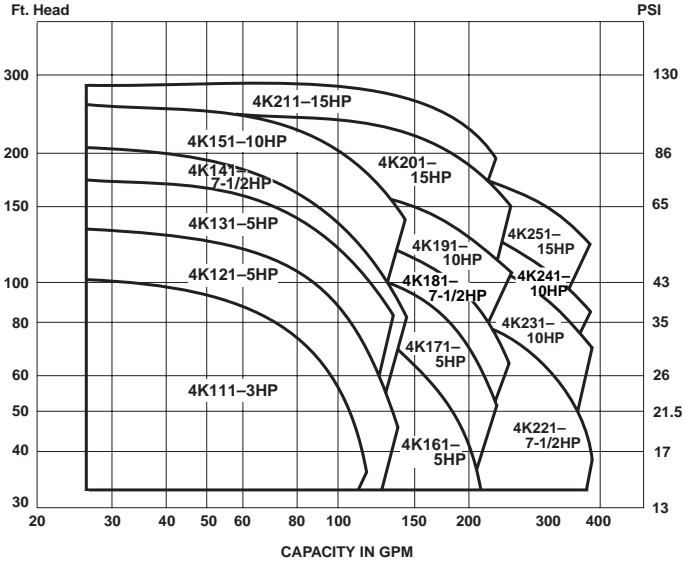

Note: See motorized pump unit codes chart to configure pump and motor.

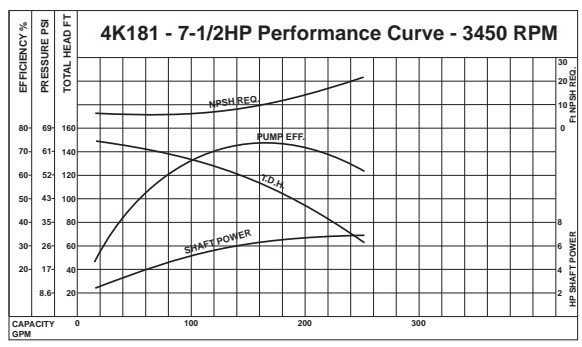
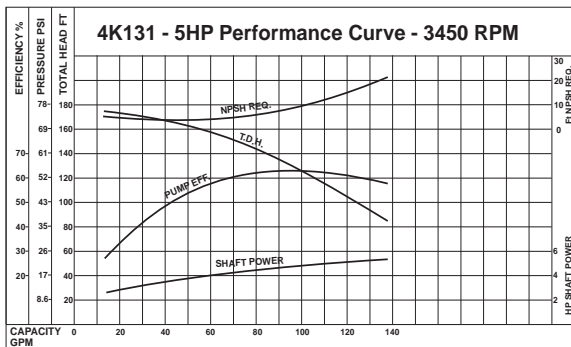
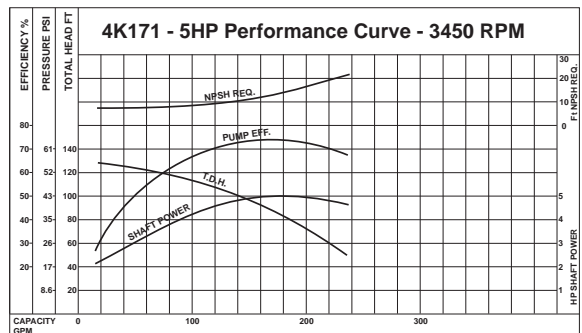
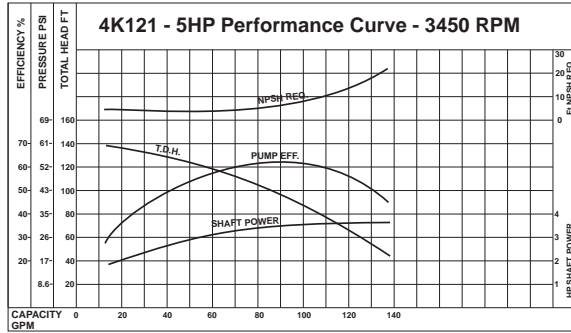
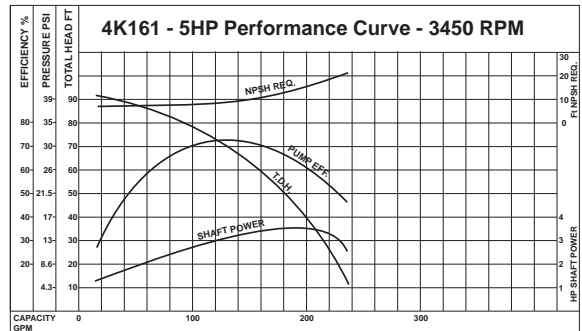
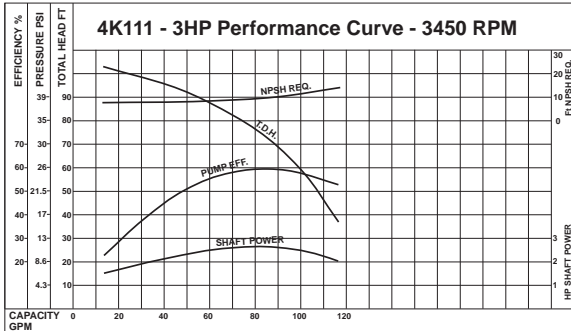
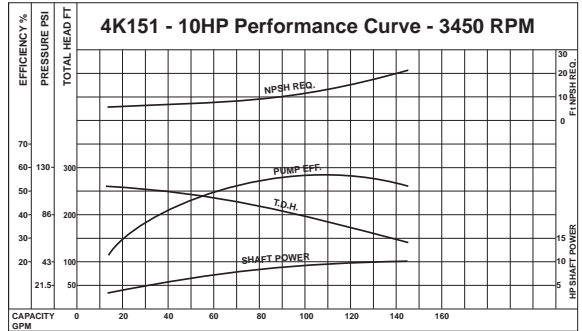
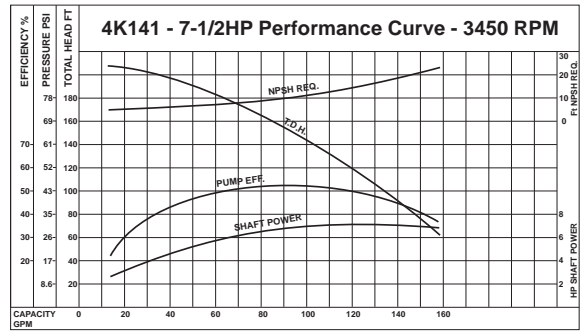

All calculations based upon water @ Spec. Gravity of 1.00

SELECTION CHART - 3450 RPM CONTINUED

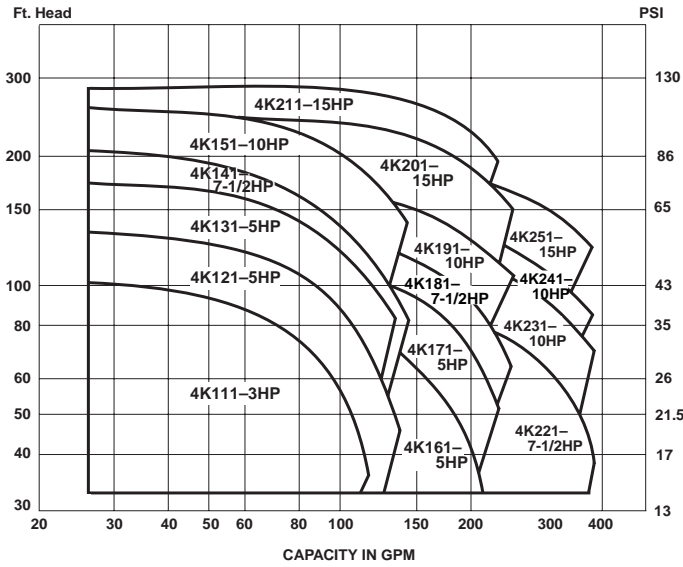

Note: See motorized pump unit codes chart to configure pump and motor.

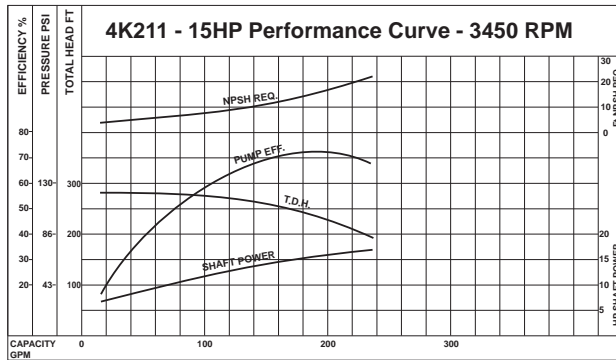
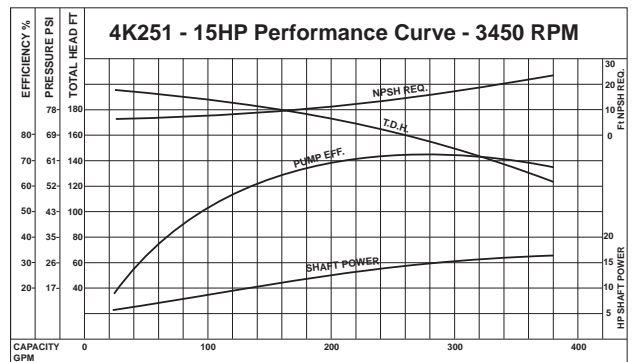
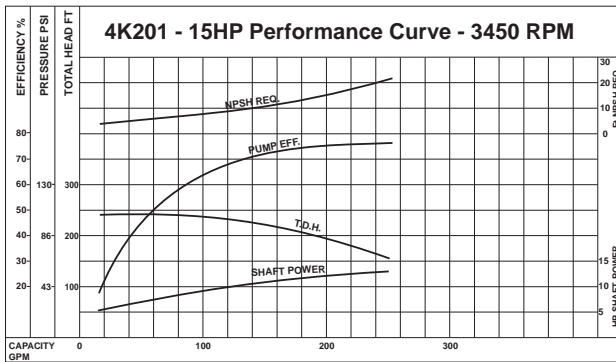
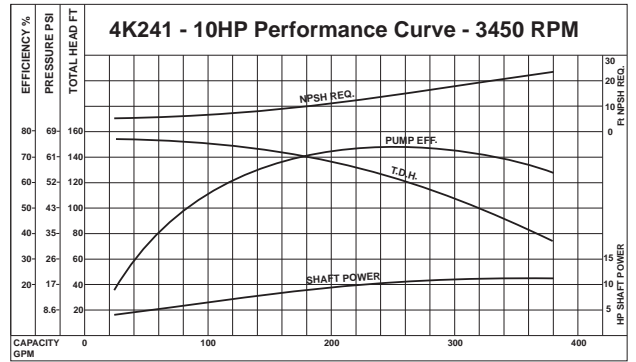
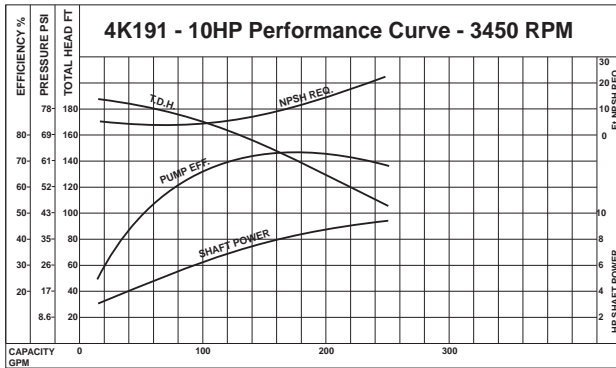
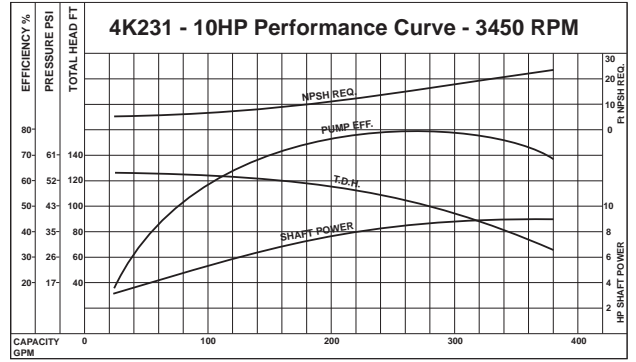
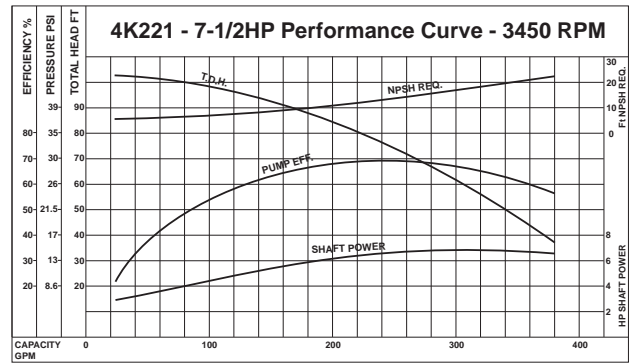

PUMP KIT PARTS LIST

ITEM	P/N	MATL	DESCRIPTION	QTY
900	—	S	Casing	1
901	—	S	Cover, Casing	1
902	—	F	Bracket	1
904	899210	S	Impeller, 5.187" (4K111)	1
	899211	S	Impeller, 5.937" (4K121)	1
	899212	S	Impeller, 6.562" (4K131)	1
	899213	S	Impeller, 7.312" (4K141, 341)	1
	899214	S	Impeller, 7.875" (4K151, 351)	1
	899215	S	Impeller, 4.937" (4K161)	1
	899216	S	Impeller, 5.500" (4K171)	1
	899217	S	Impeller, 5.937" (4K181, 381)	1
	899218	S	Impeller, 6.562" (4K191)	1
	899219	S	Impeller, 7.187" (4K201, 401)	1
	899220	S	Impeller, 7.875" (4K211, 411)	1
	899221	S	Impeller, 5.187" (4K221, 421)	1
	899222	S	Impeller, 5.500" (4K231)	1
	899223	S	Impeller, 6.187" (4K241, 441)	1
	899224	S	Impeller, 6.562" (4K251, 451)	1
907	899091	NCC	Seal, Shaft Assy (Standard)	1
	<i>899092</i>	<i>FCC</i>	<i>Seal, Shaft Assy (Mild Chemical)</i>	<i>1</i>
	<i>899093</i>	<i>HCC</i>	<i>Seal, Shaft Assy (High Temp)</i>	<i>1</i>
908	899255	FPM	O-Ring, Case (4K111, 161, 171)	1
	899256	FPM	O-Ring, Case (4K121, 131, 181, 191, 221, 231, 381, 421)	1
	899257	FPM	O-Ring, Case (4K141, 151, 201, 211, 241, 251, 341, 351, 401, 411, 441, 451)	1
909	—	S	Screw, Hex Head (M8x30 or M10x35)	8/10
911	—	S	Screw, Hex Head (3/8-16x1" or 1/2-13x1-3/4")	4
913	—	S	Nut, Hex (M8 or M10)	8/10
914	—	S	Lockwasher, Toothed (M8 or M10)	8/10
916	—	S	Lockwasher, Toothed (3/8" or 1/2")	4
922	—	S	Plug, Casing	1
924	—	STL	Support, Motor (Not Shown)	2
928	899258	S	Sleeve, Shaft	1
929	899182	NY	Gasket, Shaft Sleeve (1" ID)	1
930	899181	NY	Gasket, Shaft Seal (7/8" ID)	1
931	899268	S	Key	1
932	899180	NY	Gasket, Impeller Bolt (13/16" ID)	1
933	899306	S	Bolt, Impeller	1
934	899185	FPM	Gasket, Suction (1-1/4") (Not Shown)	1
935	899186	FPM	Gasket, Discharge (1-1/2") (Not Shown)	1

Italics are optional items.

MATERIAL CODES (Not Part of Part Number)

F=Cast Iron

FCC=Carbon/Ceramic/FPM

FPM=Fluorocarbon

HCC=Carbon/Ni/Resist/FPM

NCC=Carbon/Ceramic/Buna

NY=Nylon

S=304SS

STL=Steel

EXPLODED VIEW

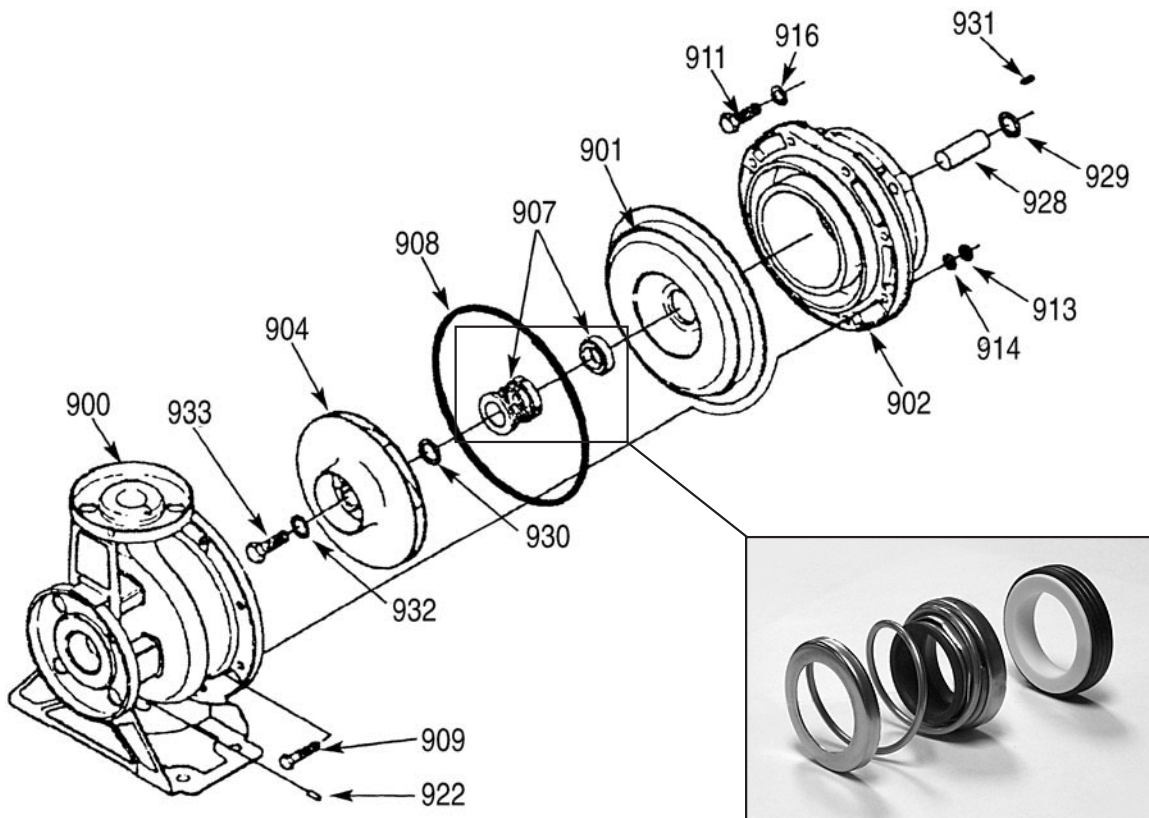

MODELS
3450 RPM - 4K111-4K253
1725 RPM - 4K341-4K353
April 2012

GENERAL SAFETY AND OPERATION

SELECTION: Review the Selection Chart to find the performance range and pump model suited to your application requirements. Then review the Performance Curve Chart to verify the most efficient performance and inlet conditions required.

INSTALLATION: These pumps may be installed in either a horizontal (most common) or vertical position (as installation requires). The following criteria should be considered to assure optimum performance:

- Proper alignment of plumbing
- Adequate line size to prevent starvation
- Rigid metal or plastic pipe or reinforced flexible plumbing to prevent collapsing lines
- Properly sealed connections to prevent air leaks
- Good filtration of the liquid to avoid abrasives and solids
- Foot valve may need to be installed at the inlet

OPERATION: The pump comes with a standard seal for fresh water or non harsh liquids. Excessive pH, high viscosity and abrasives will affect the life and performance of the pump. Special shaft seals are available for high temperature or chemical duty applications. Check with Cat Pumps for high viscosity liquids. Make certain there is sufficient liquid supply to the pump before starting operation.

MAINTENANCE: This is a low maintenance pump. The shaft seal and impeller are the primary service items. These can be easily replaced.

1. Remove the 8 or 10 hex screws and slide the casing from the cover.
2. Remove the impeller bolt and gaskets then slide off impeller.
3. Carefully pry the casing cover away from the bracket.
4. Lay the cover on the work surface (large diameter up) and press out the shaft seal.
5. Turn the cover over on the work surface (small diameter up) and press the **back half** (stationary half) of the new shaft seal into position until completely seated in the chamber with the **elastomer side down**.

CAUTION

Exercise care when handling the shaft seal. It can be easily contaminated by improper handling and will not properly seal. Use the paper cover to press the seal into position and toss the cover when done.

NOTE: If seal installation is tight, carefully apply a small amount of lubricant to the **outer edge** (non-chlorine dish soap).
DO NOT USE OIL OR GREASE.

6. Align the cover with the holes on the bracket and press into position.

7. Slide the **front half** of the seal (rotating half) onto the shaft with the **elastomer side out** (carbon/ceramic surfaces mating). Then slide the seal spring and washer onto the shaft.
8. Hold the seal spring in place and thread the impeller into position until completely seated.
NOTE: Use a screwdriver to hold the motor shaft stationary.
9. Install the impeller hex nut onto the shaft and torque per chart. Rotate the impeller to assure proper alignment before installing the cover.
NOTE: Apply Loctite® 609 to the impeller nut before installing.
10. Place the new O-Ring over the casing cover. Exercise caution not to cut or twist the O-Ring during installation.
11. Replace the casing cover. Rotate to desired discharge port position and align holes. Replace 8 lockwashers and socket screws and torque per chart.

TORQUE CHART

	Size	Torque		
		ft. lbs.	in. lbs.	Nm
Impeller Bolt	3/8-16	12-18	144-215	16-24
Pump Casing	M8 x 30 Hex Head Screw or	8.0	96	10.8
	M10 x 35 Hex Head Screw	8.0	96	10.8
(To Motor Bracket)	M8 Ext. Tooth Lockwasher or M10 Ext. Tooth Lockwasher			
Motor Bracket	3/8" -16 x 1" Hex Head Screw or	8.0	96	10.8
	1/2"-13x1-3/4" Hex Head Screw	8.0	96	10.8
(To Motor)	3/8" Ext. Tooth Lockwasher or 1/2" Ext. Tooth Lockwasher			

TROUBLESHOOTING

PROBLEM	SOLUTION
• No flow or low flow	• Check rotation of pump • Check liquid supply to pump
• Leaking	• Replace shaft seal • Check case cover o-ring
• Noise	• Check liquid supply to pump • Check viscosity of liquid • Review NPSH requirements
• Vibration	• Secure plumbing to and from pump • Check impeller and replace as needed

WARRANTY

This pump is warranted for one year from date of purchase.
Improper installation and use will void the warranty.
Tampering with the impeller or seals will void the warranty.

Loctite is a registered trademark of the Henkel Corporation.



CAT PUMPS

1681 - 94TH LANE N.E. MINNEAPOLIS, MN 55449-4324
PHONE (763) 780-5440 — FAX (763) 780-2958
e-mail: techsupport@catpumps.com
www.catpumps.com