

## Close Coupled Centrifugal Pumps

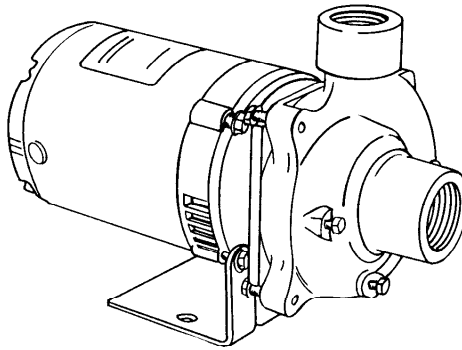

**3450 RPM - 60Hz.**  
 CAPACITIES TO 120 GPM (7.6 LPS)  
 HEADS TO 55 FEET (16.8M)

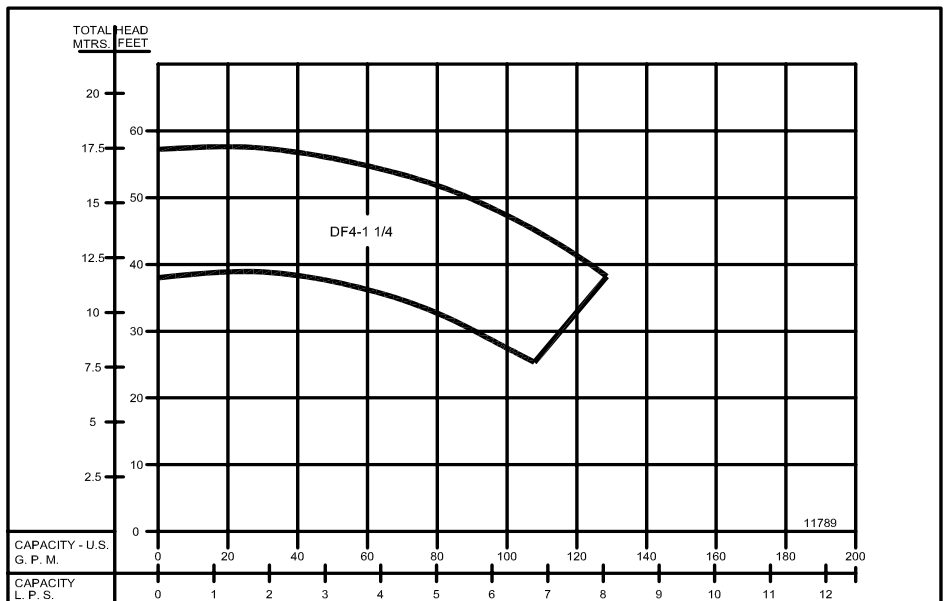

**2900 RPM - 50Hz.**  
 CAPACITIES TO 105 GPM (6.6 LPS)  
 HEADS TO 36 FEET (11 M)



Individual performance curves should be checked for final selection.

**Close Coupled Centrifugal Pumps**

**FOUR POSITION CASING**

Centerline discharge can be located in any of four positions. Back pull-out design eliminates the need to disturb piping should the pump ever require service - the casing stays in the line.

**ENCLOSED IMPELLER**

Of the latest hydraulic design for maximum efficiency, impeller is balanced for vibration-free operation and threaded onto stainless steel motor shaft.

**MECHANICAL SHAFT SEAL**

Standard self-adjusting shaft seal for temperatures to 225°F (107°C) and pressures to 150 psi (1034kpa). Ceramic seat and carbon seal face for long trouble-free service. Special seals are available for higher temperatures and fluids other than water.

**MOTORS**

Standard pump motors have open drip proof construction and are rated with jet pump service factors for continuous duty operation. Motors are 56 frame size with NEMA standard mounting flange, one piece threaded stainless steel shaft and ball/ball bearing construction.

**FACTORY TESTED**

After careful assembly and inspection, EVERY pump is factory tested and will meet Hydraulic Institute standards.

**MOTOR INFORMATION**

60 Hz - 3500 RPM - ODP  
 Single Phase: 115/230 Volt  
 Three Phase: 208-230/460 Volt

50 Hz - 2900 RPM - ODP  
 Single Phase: 110/220 Volt  
 Three Phase: 380 Volt

Voltages may differ from some suppliers. Consult factory.

**OVERLOAD PROTECTION**

All single phase ODP and Totally Enclosed motors have built-in overload protection. All three phase motors and all explosion proof motors must be installed with a magnetic starter which provides full 3-leg protection. Failure to use correct starter and overloads will void motor warranty.

**MATERIALS OF CONSTRUCTION**

PART	ALL IRON	BRONZE FITTED	ALL BRONZE
Adapter	Cast Iron	Cast Iron	Bronze
Casing	Cast Iron	Cast Iron	Bronze
Impeller	Cast Iron	Bronze	Bronze
Shaft	#303 Stainless	#303 Stainless	#303 Stainless
Shaft Seal	Carbon-Ceramic SS - Buna-N	Carbon-Ceramic SS - Buna-N	Carbon-Ceramic SS - Buna-N

**MAXIMUM OPERATING CONDITIONS**

TEMPERATURE (For Standard Buna-N Seal)	225°F (107°C)
INLET PRESSURE	100 PSI (689kPa)
CASING WORKING PRESSURE	200 PSI (1379kPa)

## Close Coupled Centrifugal Pumps

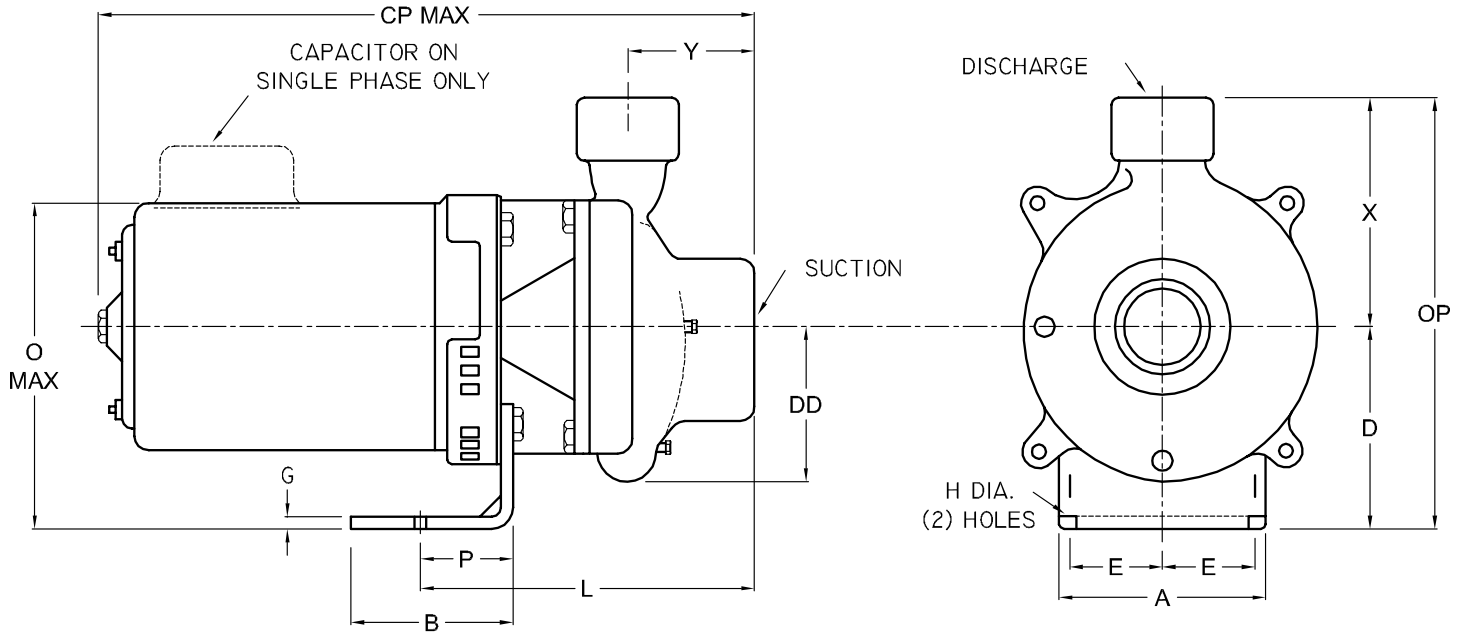

DIMENSIONS IN INCHES (mm)																	
MODEL	MOTOR FRAME SIZE	DISC NPT	SUCT. NPT	A	B	CP	D	DD	E	G	H	L	O	OP	P	X	Y
DF4-1¼	56	1¼	1½	4 <sup>7</sup> / <sub>8</sub> (124)	5 (127)	16 <sup>9</sup> / <sub>16</sub> (421)	4 <sup>3</sup> / <sub>4</sub> (121)	3 <sup>1</sup> / <sub>8</sub> (79)	1 <sup>15</sup> / <sub>16</sub> (49)	3 <sup>3</sup> / <sub>16</sub> (4.7)	½ (13)	7 <sup>3</sup> / <sub>4</sub> (197)	8 <sup>9</sup> / <sub>16</sub> (217)	9 <sup>7</sup> / <sub>8</sub> (251)	2 <sup>5</sup> / <sub>16</sub> (59)	5 <sup>1</sup> / <sub>8</sub> (130)	3 <sup>1</sup> / <sub>8</sub> (79)

DIMENSIONS SHOWN ABOVE ARE APPROXIMATE MAXIMUM DIMENSIONS FOR STANDARD PUMPS EQUIPPED WITH ODP MOTORS.

**Close Coupled Centrifugal Pumps**

3500 RPM

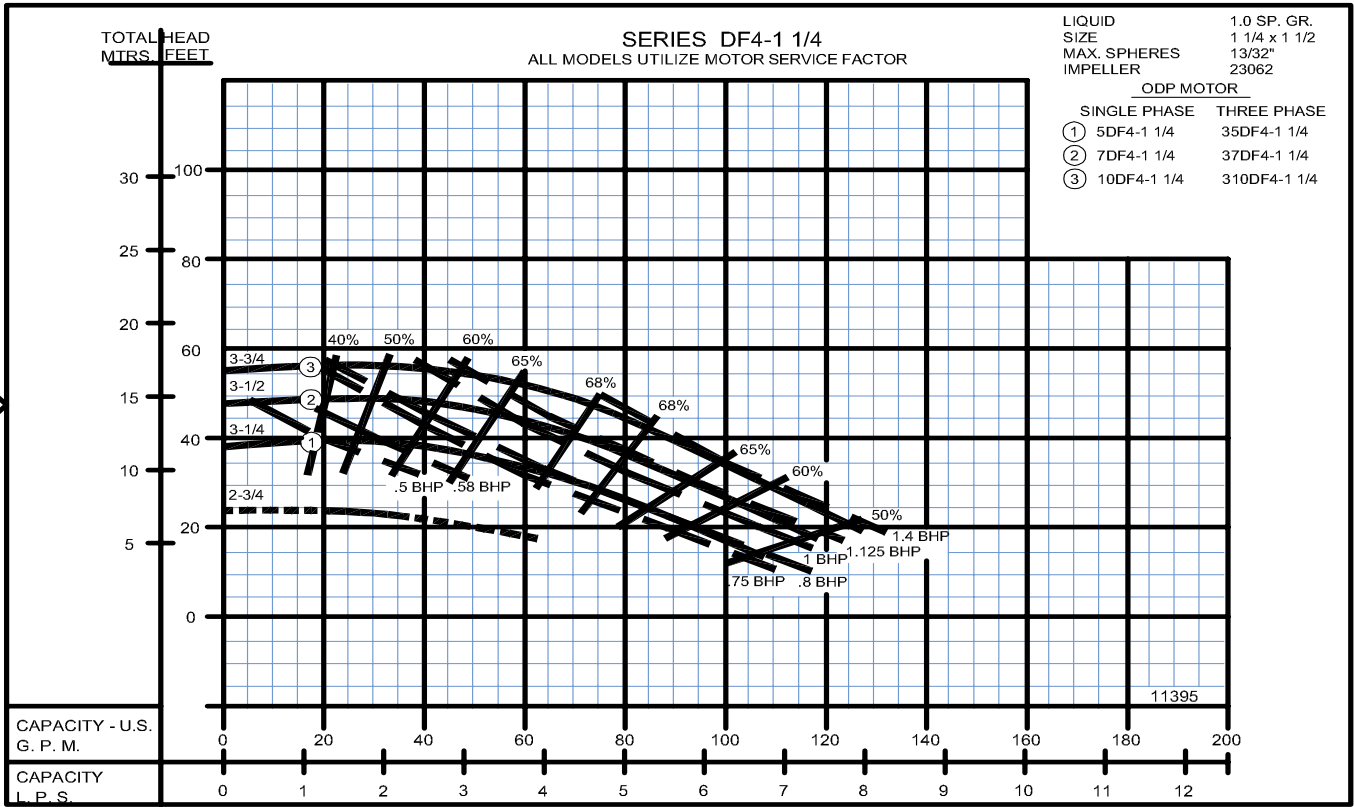

3500 RPM

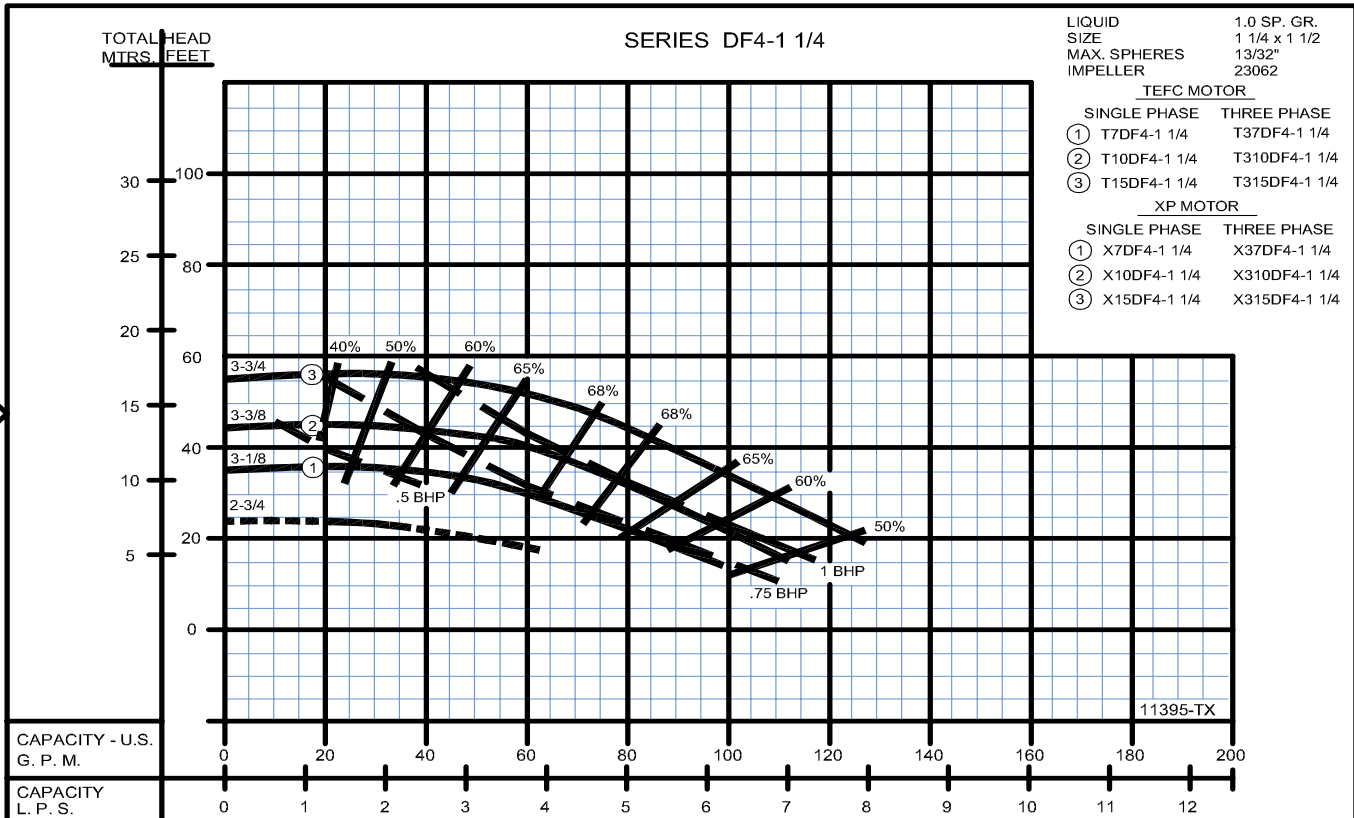

## Close Coupled Centrifugal Pumps

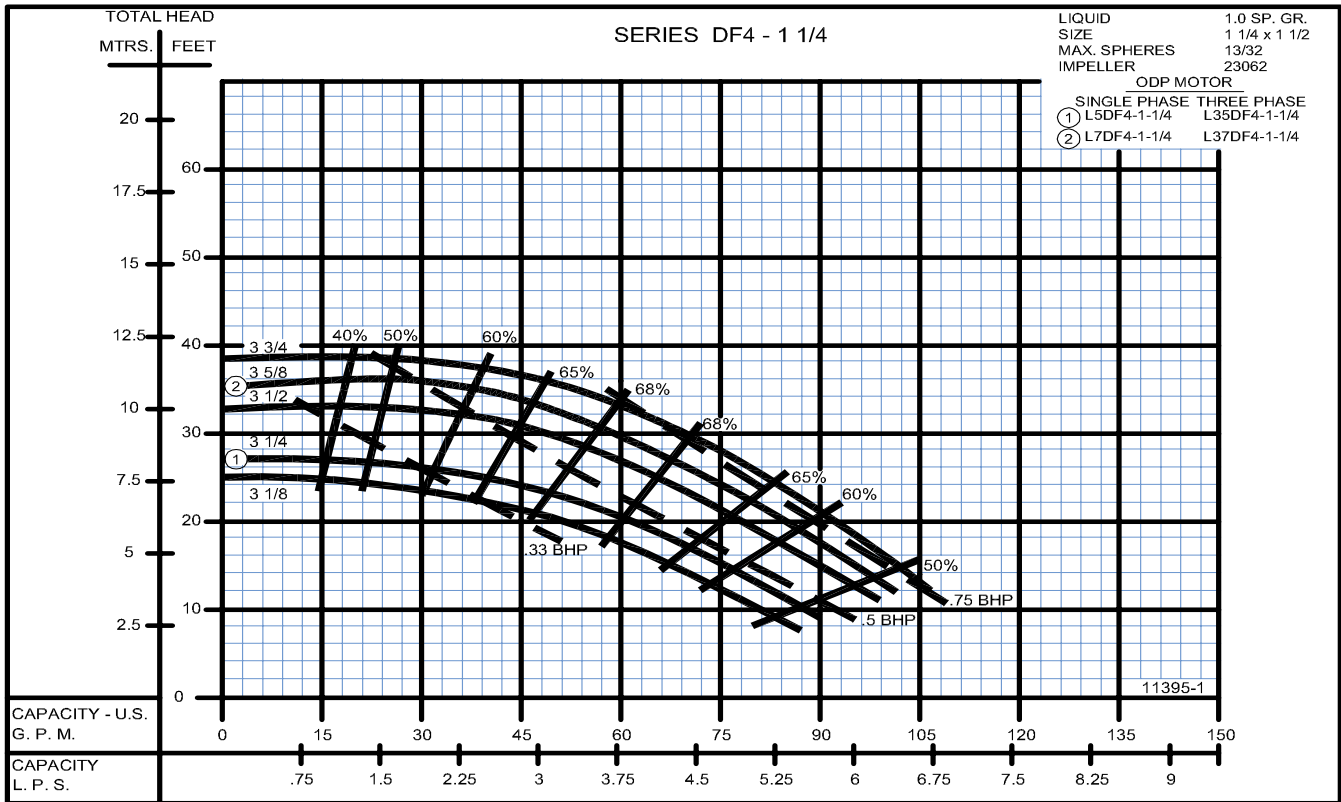

2900  
RPM

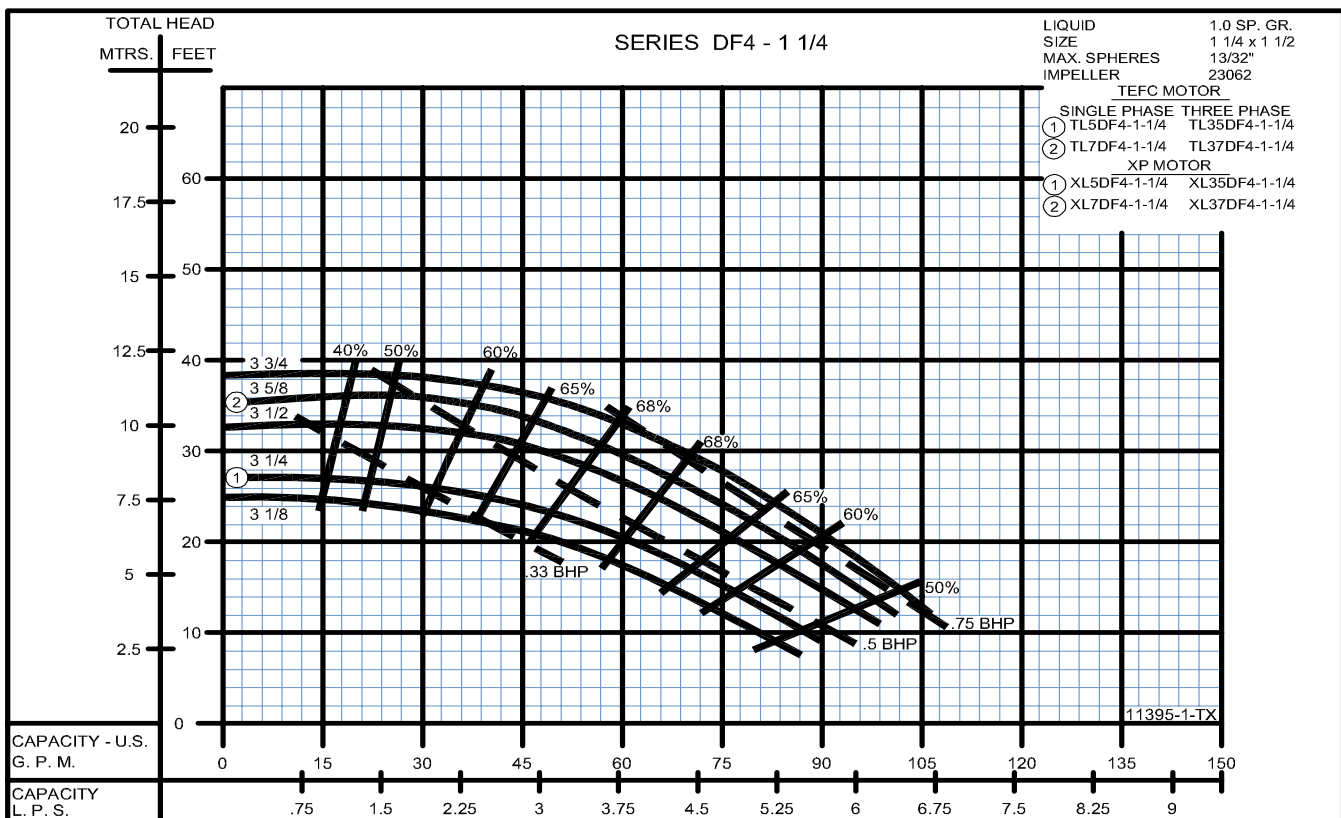

2900  
RPM