

Close Coupled Centrifugal Pumps

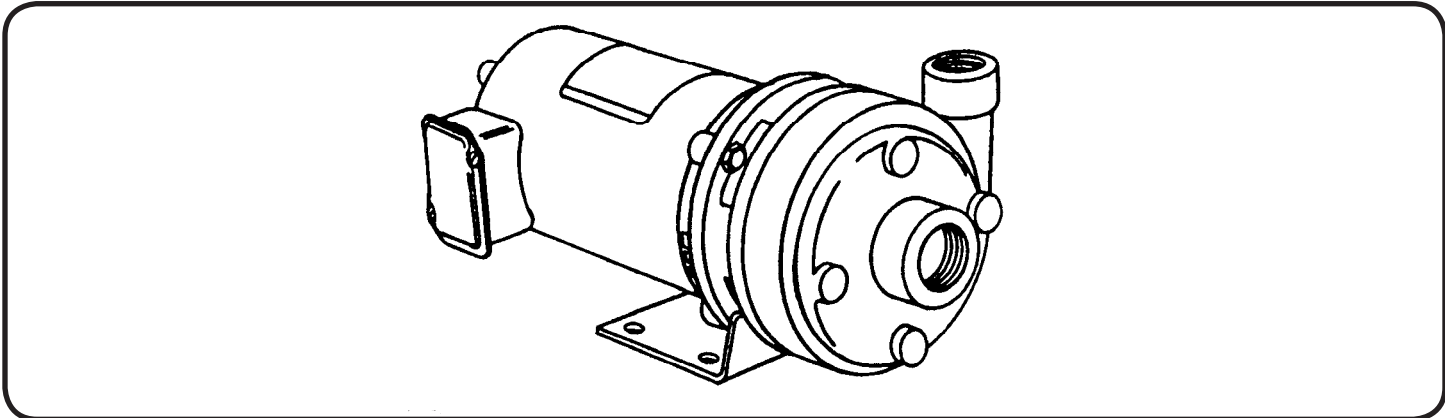

3500 RPM - 60Hz.
 CAPACITIES TO 130 GPM (8.2 LPS)
 HEADS TO 75 FEET (23 M)

(*) FOR CAPACITIES ABOVE 100 GPM
 SEE GA4-1 1/2 CURVE.

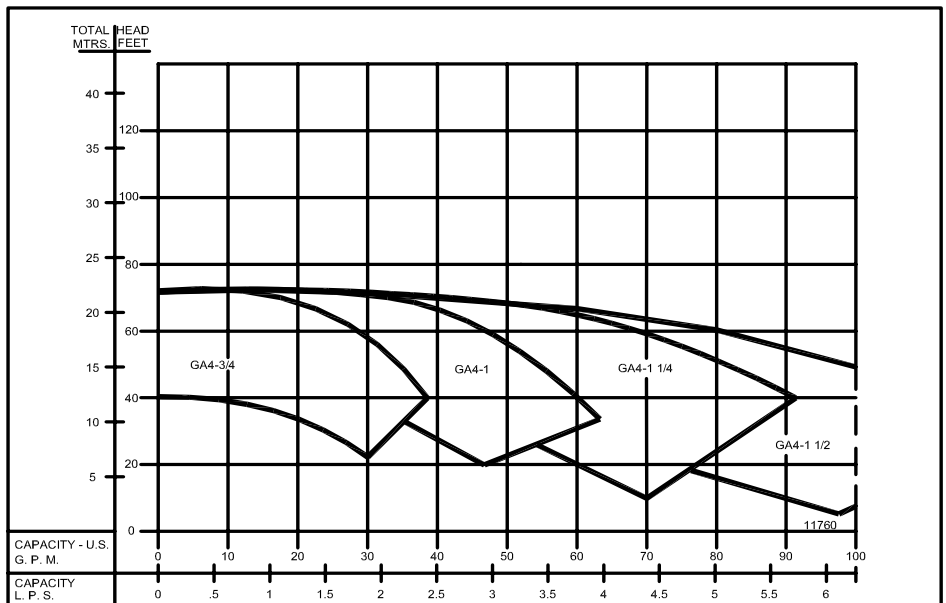

2900 RPM - 50Hz.
 CAPACITIES TO 108 GPM (6.8 LPS)
 HEADS TO 50 FEET (15 M)

Individual performance curve should be
 checked for final selection.

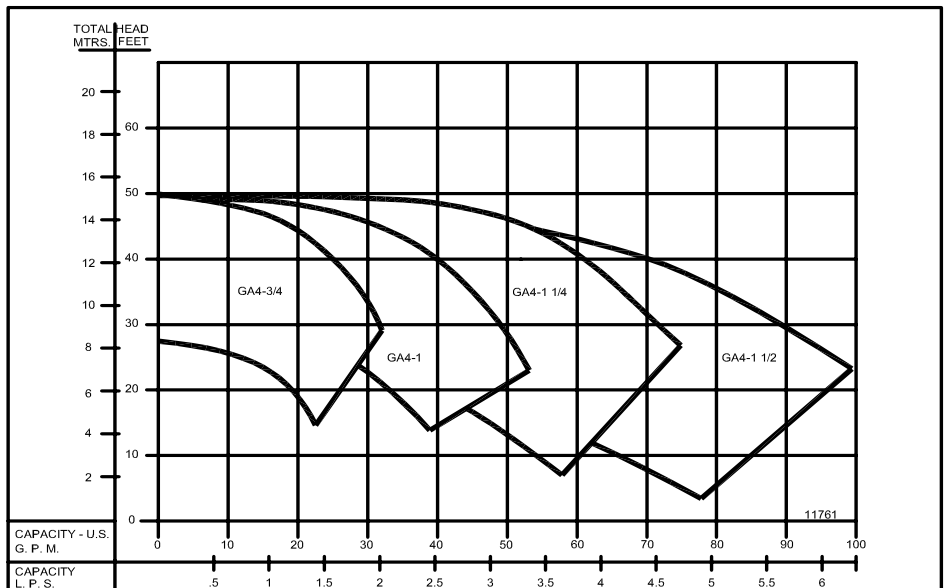

Close Coupled Centrifugal Pumps

FOUR POSITION CASING

Discharge can be located in any of four positions. Casing is close grain iron of 30,000 psi minimum tensile strength. Back pull-out design eliminates the need to disturb piping should the pump ever require service - the casing stays in the line.

ENCLOSED CAST IRON IMPELLER

Of the latest hydraulic design for maximum efficiency, impeller is balanced for vibration-free operation and threaded onto stainless steel motor shaft. Impeller is available in bronze.

MECHANICAL SHAFT SEAL

Standard self-adjusting shaft seal for temperatures to 225°F (107°C) and pressures to 150 psi (1034 kpa). Ceramic seat and carbon seal face for long trouble-free service. Special seals are available for higher temperatures and fluids other than water.

MOTORS

Standard pump motors are of open drip proof (ODP) construction and are rated with jet pump service factors for continuous duty operation. Motors are 56 frame size with NEMA standard mounting flange, one piece threaded stainless steel shaft and ball/ball bearing construction.

FACTORY TESTED

After careful assembly and inspection, EVERY pump is factory tested and meets Hydraulic Institute standards.

MAXIMUM OPERATING CONDITIONS

TEMPERATURE (For Standard Buna-N Seal)	225°F (107°C)
INLET PRESSURE	70 PSI (433kPa)
CASING WORKING PRESSURE	100 PSI (690kPa)

MOTOR INFORMATION

60 Hz - 3500 RPM - ODP
Single Phase: 1/3 thru 2 Hp. - 115/230 Volt
3 Hp. - 230 Volt only
Three Phase: 1/3 thru 3 Hp. - 208-230/460 Volt

50 Hz - 2900 RPM - ODP
Single Phase: 110/220 Volt
Three Phase: 380 Volt

Voltages may differ from some suppliers. Consult factory.
Overload Protection: All single phase ODP and Totally Enclosed motors have built-in overload protection. All three phase motors and all explosion proof motors must be installed with a magnetic starter which provides full 3-leg protection. Failure to use correct starter and overloads will void motor warranty.

MATERIALS OF CONSTRUCTION

PART	ALL IRON	BRONZE FITTED	ALL BRONZE
Adapter	Cast Iron	Cast Iron	Bronze
Casing	Cast Iron	Cast Iron	Bronze
Impeller	Cast Iron	Bronze	Bronze
Shaft	#303 Stainless	#303 Stainless	#303 Stainless
Shaft Seal	Carbon-Ceramic SS - Buna-N	Carbon-Ceramic SS - Buna-N	Carbon-Ceramic SS - Buna-N

Close Coupled Centrifugal Pumps

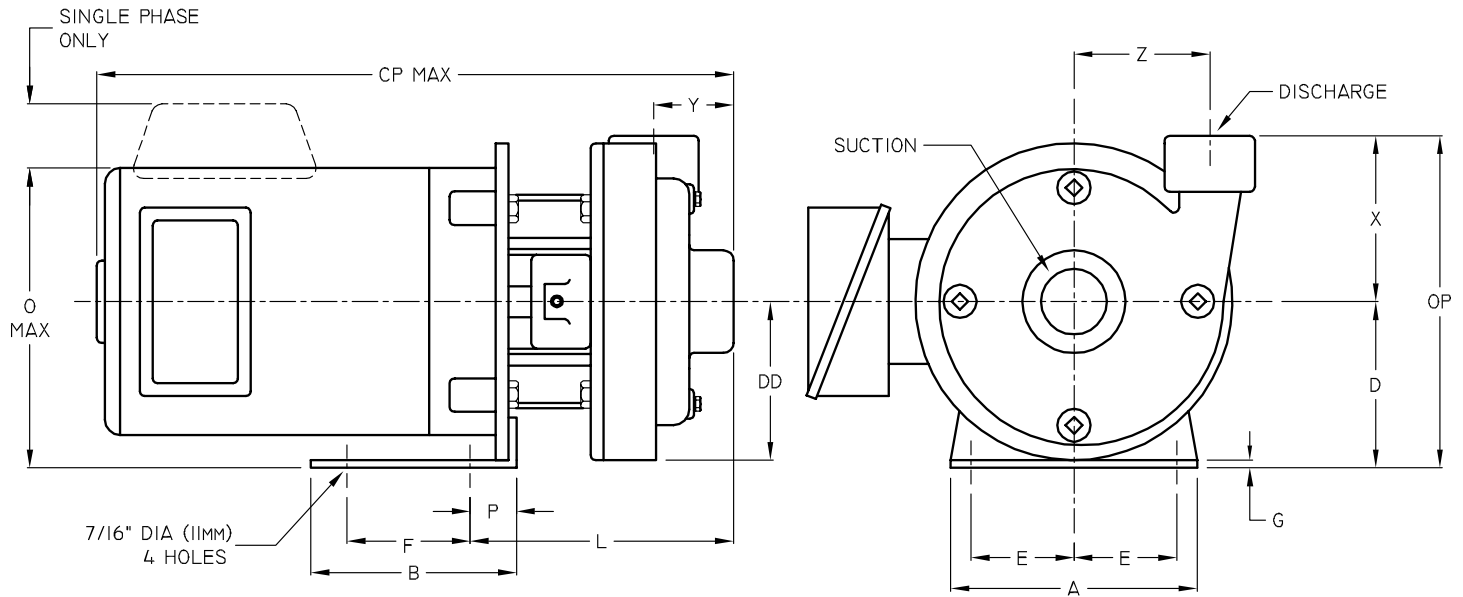

DIMENSIONS IN INCHES																		
MODEL	MOTOR FRAME SIZE	DISC NPT (in)	SUCT. NPT (in)	A	B	CP	D	DD	E	F	G	L	O	OP	P	X	Y	Z
GA4-¾	56	¾	1	6	5	15½	3½	3 ⁵ / ₁₆	2½	3	¾	5½	6¾	7	1⅞	3½	2 ¹ / ₁₆	2 ⁵ / ₈
GA4-1	56	1	1¼	6	5	15 ⁹ / ₁₆	3½	3 ⁵ / ₁₆	2½	3	¾	5 ⁹ / ₁₆	6¾	7	1⅞	3½	1 ¹⁵ / ₁₆	2 ¹¹ / ₁₆
GA4-1¼	56	1¼	1½	6	5	15 ¹³ / ₁₆	3½	3 ⁵ / ₁₆	2½	3	¾	5 ¹⁵ / ₁₆	6¾	7½	1⅞	4	2 ³ / ₁₆	3
GA4-1½	56	1½	2	6	5	16 ¹ / ₁₆	3½	3 ⁷ / ₁₆	2½	3	¾	6 ¹ / ₁₆	6¾	8	1⅞	4½	2 ⁵ / ₁₆	3⅞

DIMENSIONS IN MILLIMETERS																		
MODEL	MOTOR FRAME SIZE	DISC NPT (in)	SUCT. NPT (in)	A	B	CP	D	DD	E	F	G	L	O	OP	P	X	Y	Z
GA4-¾	56	¾	1	152	127	394	89	84	64	76	4.8	140	172	178	29	89	52	67
GA4-1	56	1	1¼	152	127	395	89	84	64	76	4.8	141	172	178	29	89	49	68
GA4-1¼	56	1¼	1½	152	127	402	89	84	64	76	4.8	151	172	191	29	102	55	76
GA4-1½	56	1½	2	152	127	408	89	87	64	76	4.8	154	172	203	29	114	59	79

DIMENSIONS SHOWN ABOVE ARE APPROXIMATE MAXIMUM DIMENSIONS FOR STANDARD PUMPS EQUIPPED WITH ODP MOTORS.

Close Coupled Centrifugal Pumps

3500 RPM

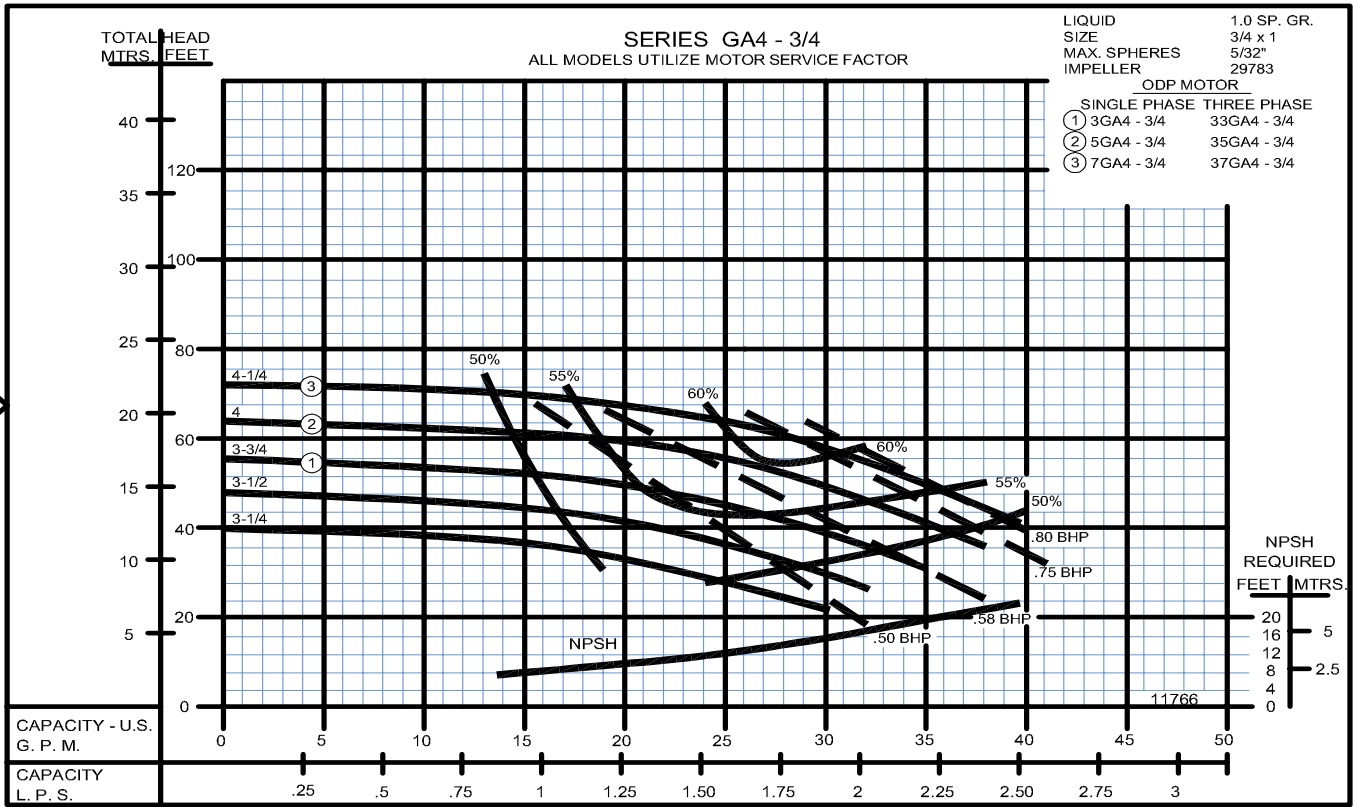

3500 RPM

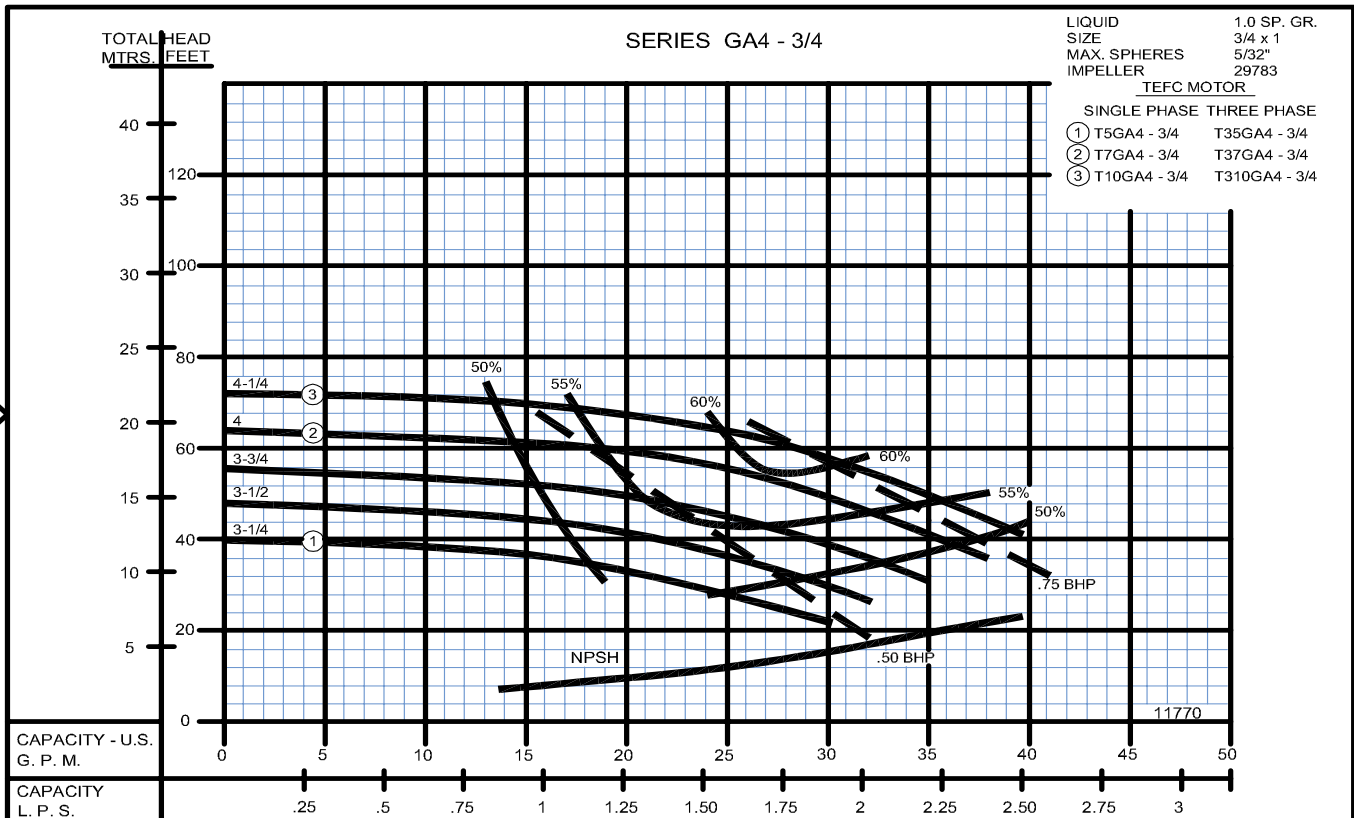

Close Coupled Centrifugal Pumps

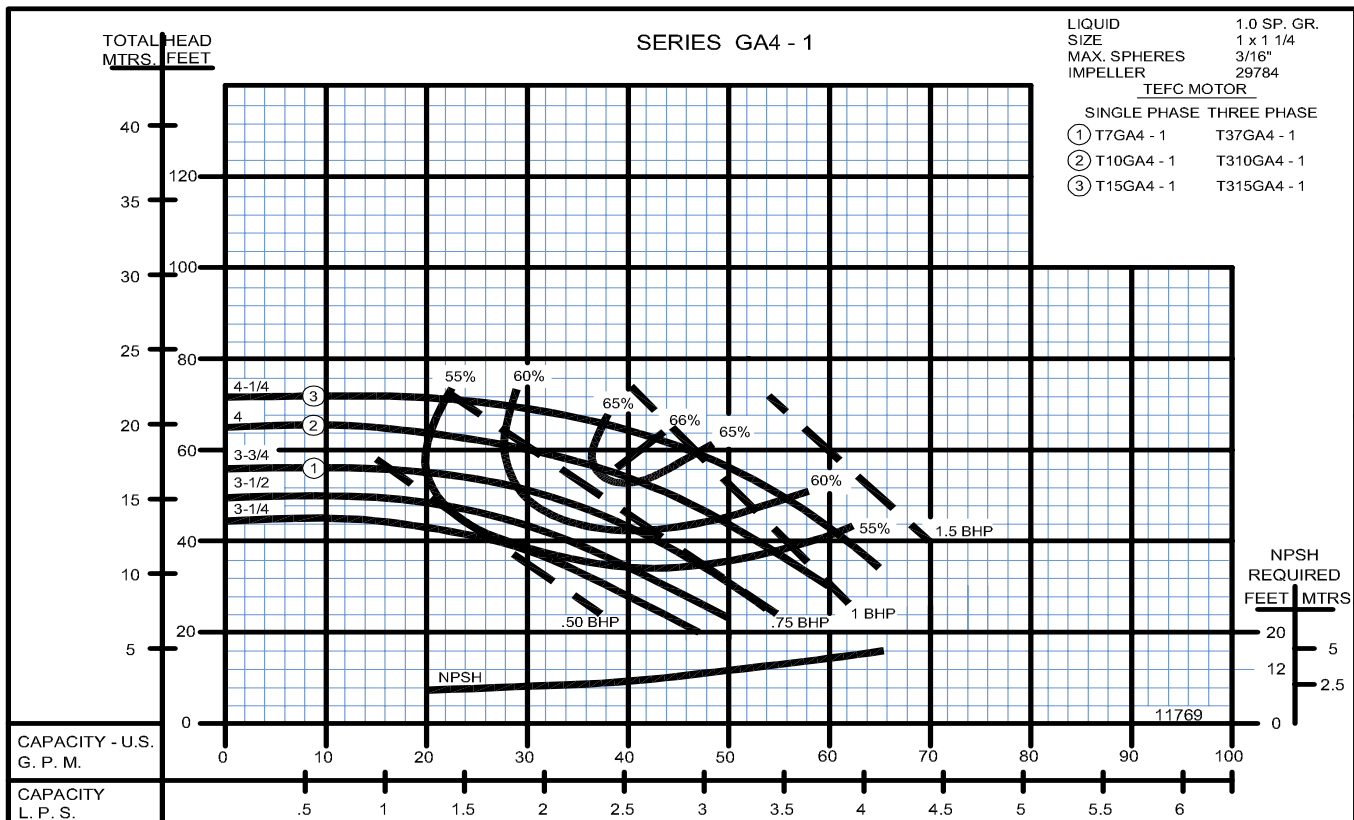
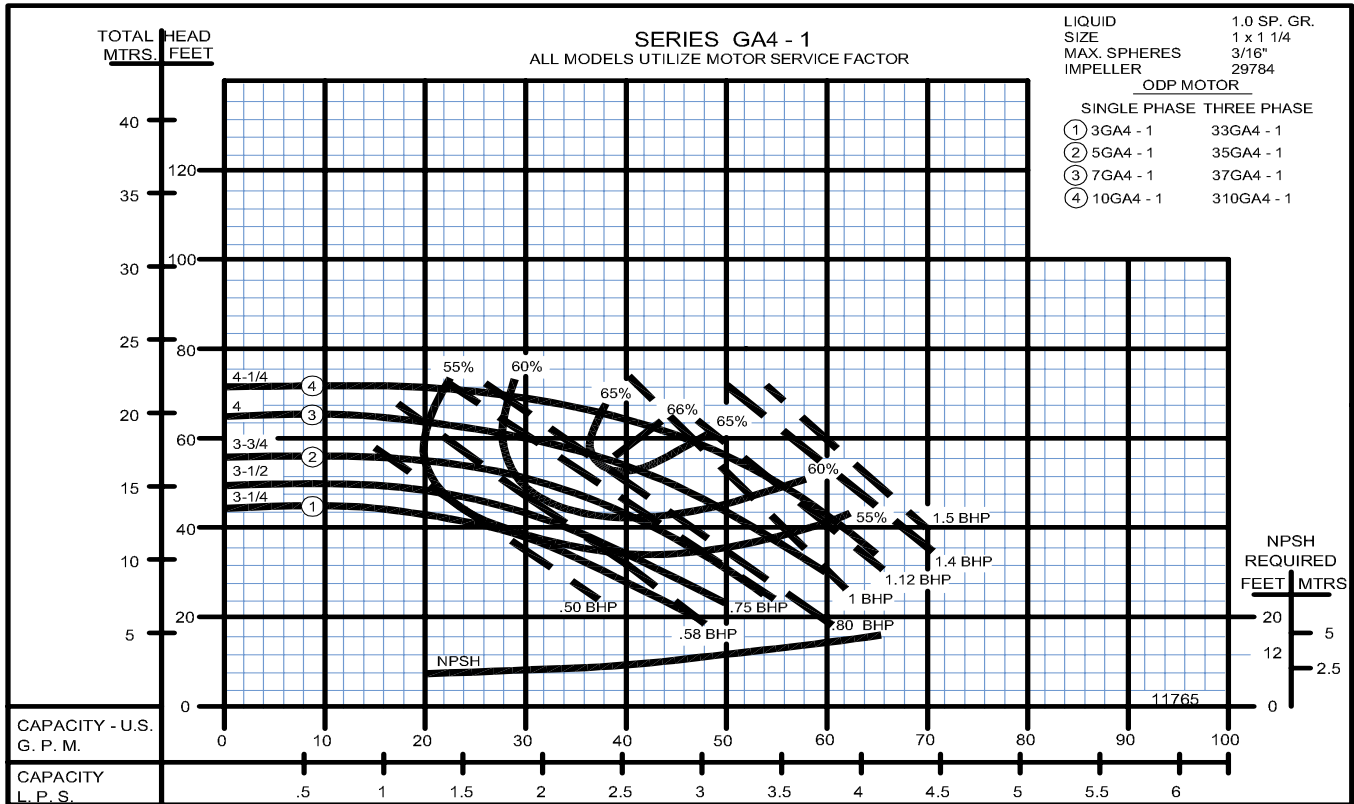

Close Coupled Centrifugal Pumps

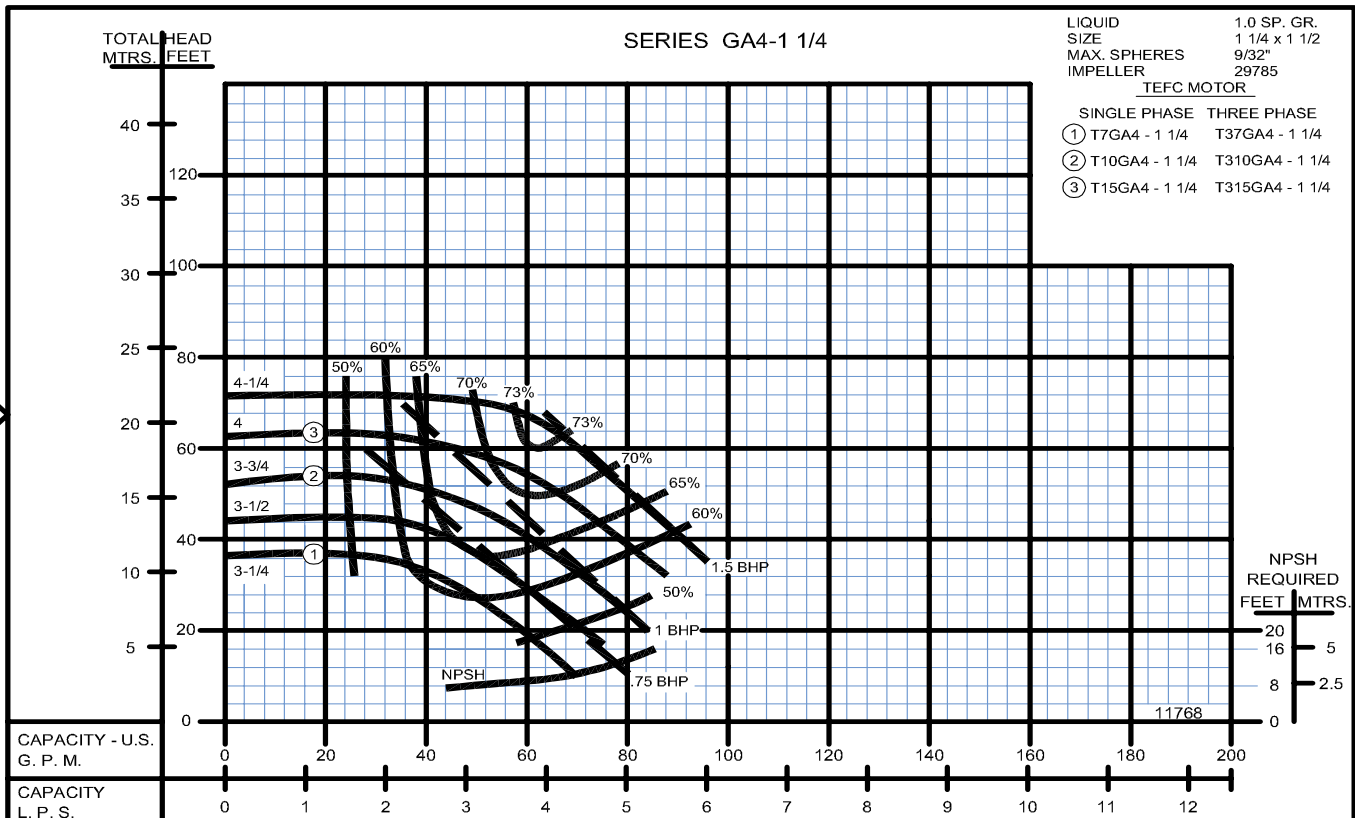
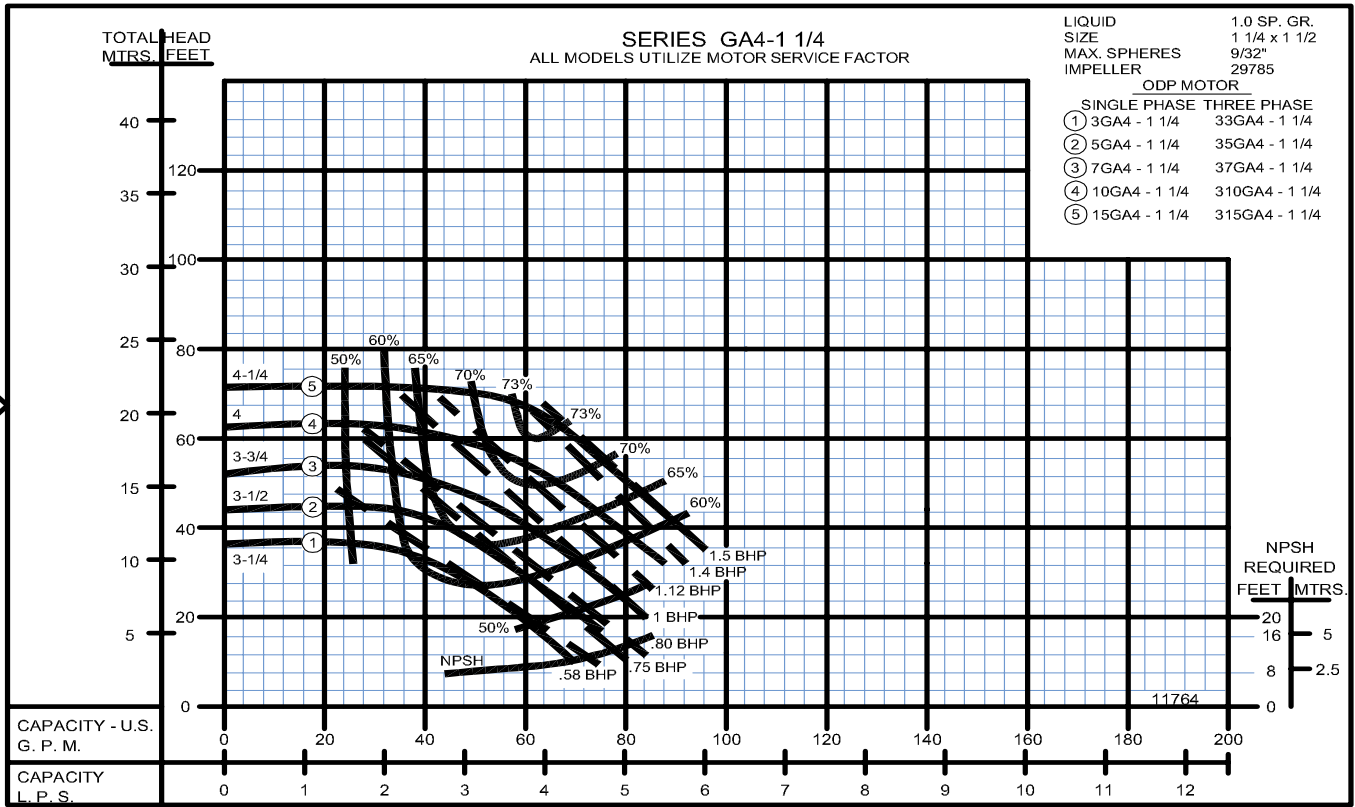

Close Coupled Centrifugal Pumps

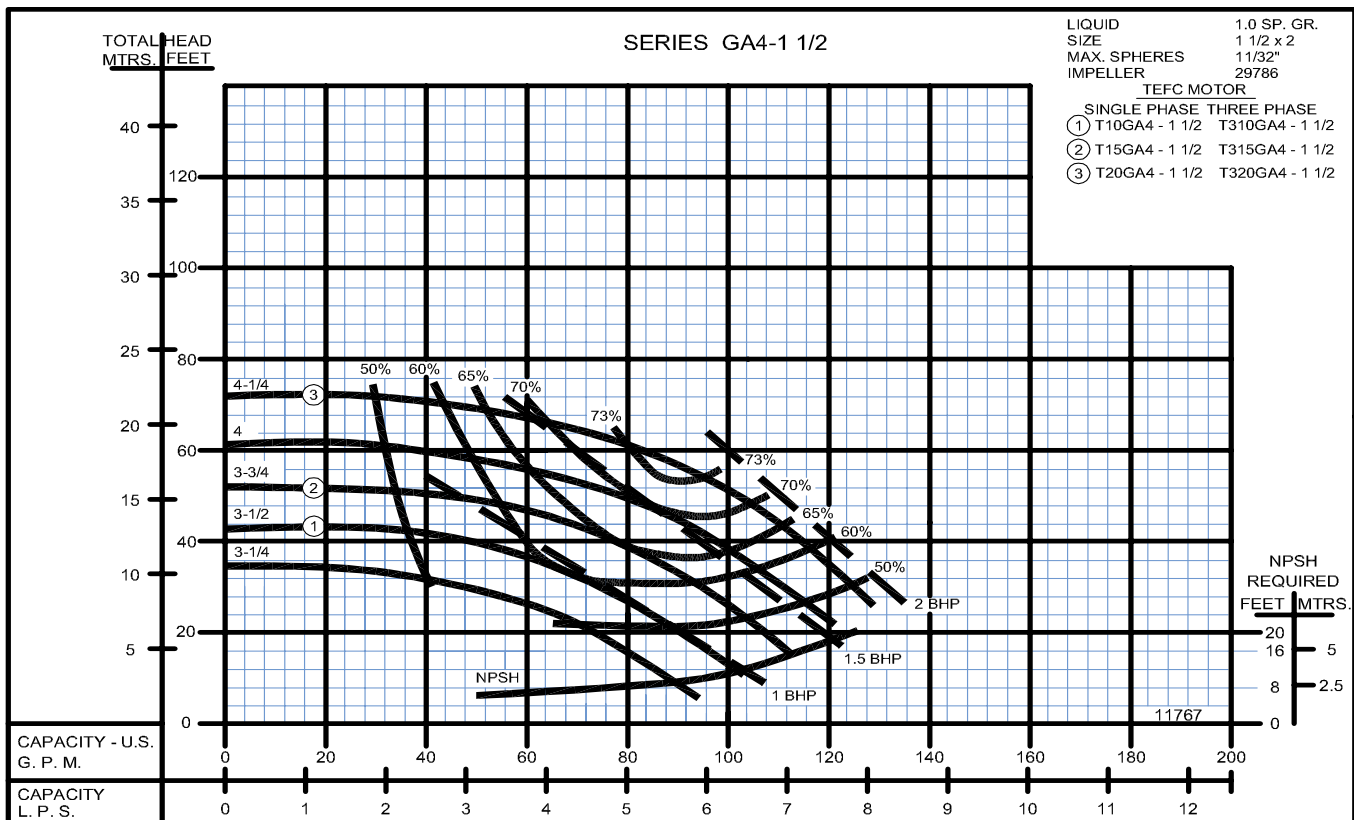
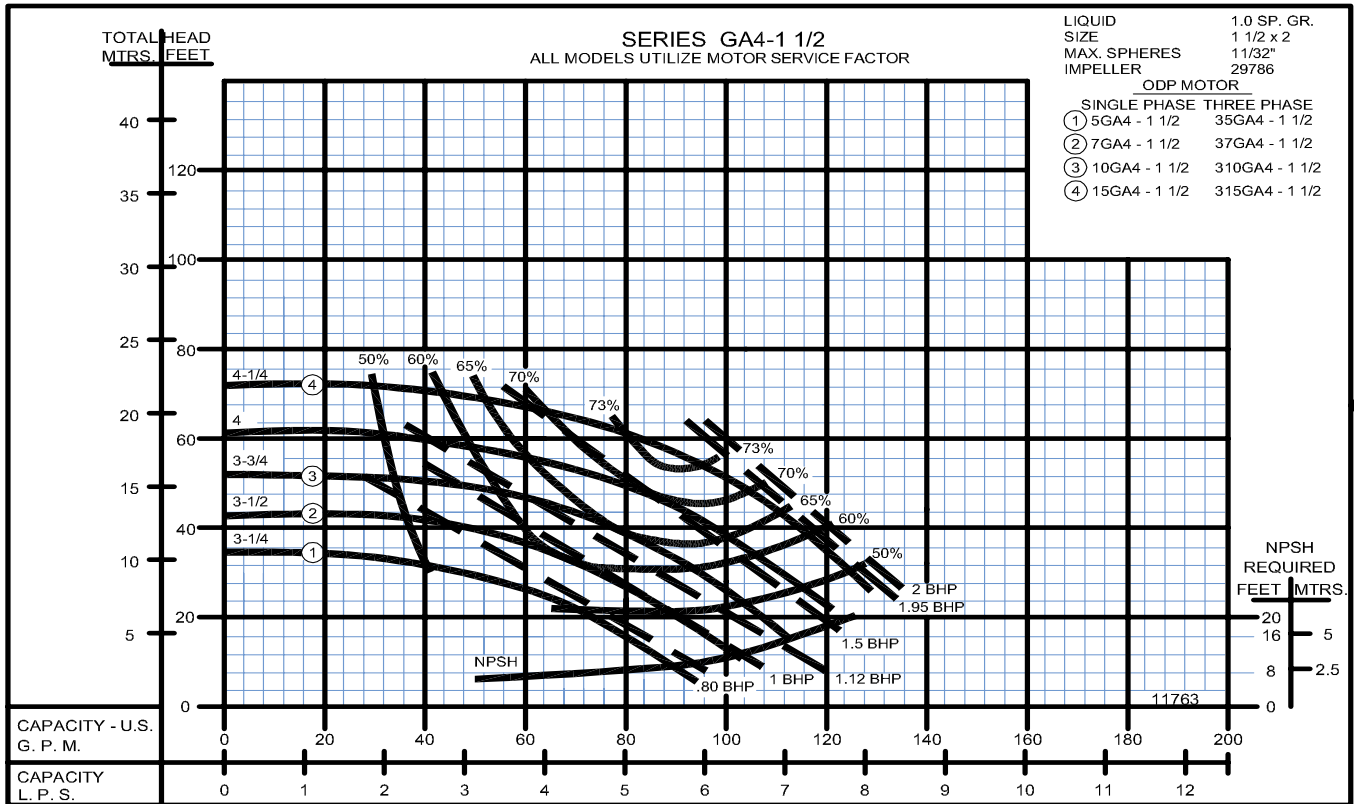

Close Coupled Centrifugal Pumps

2900 RPM

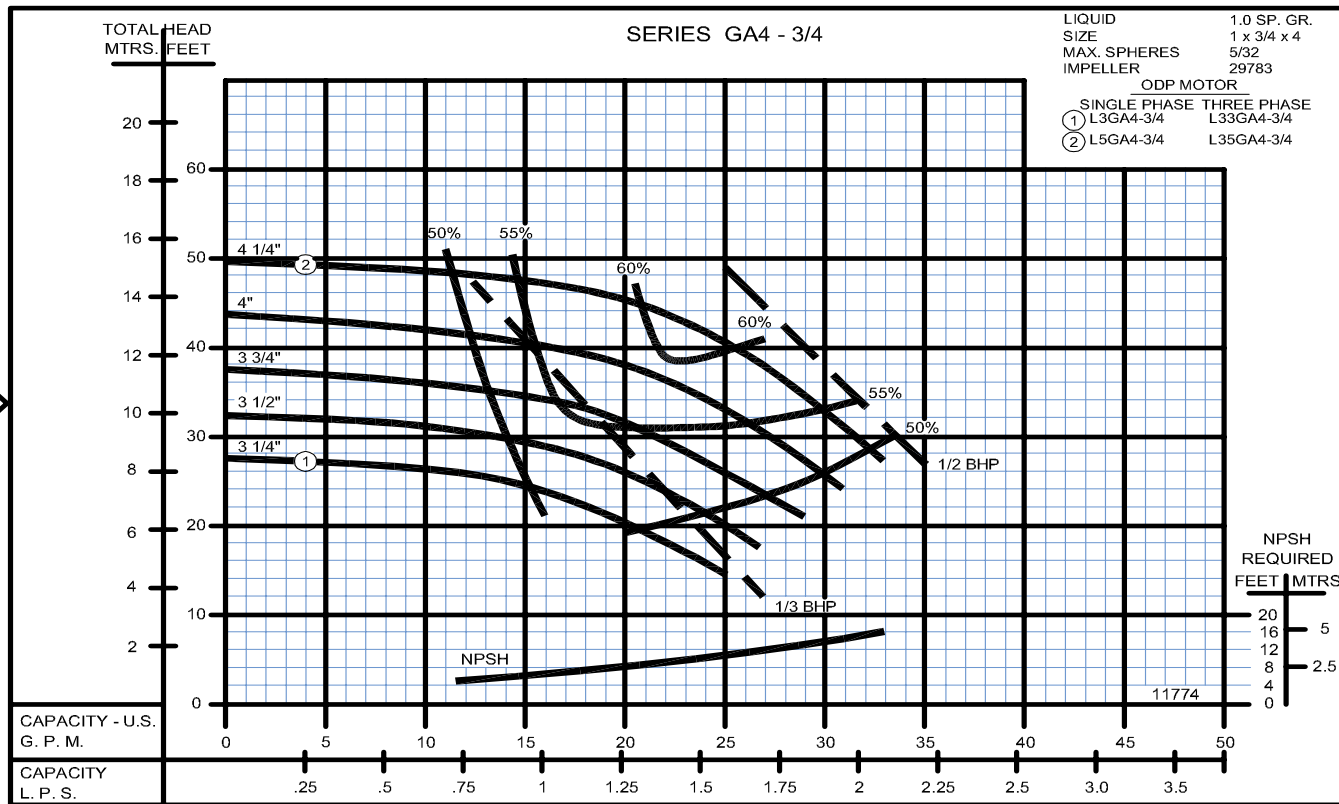

2900 RPM

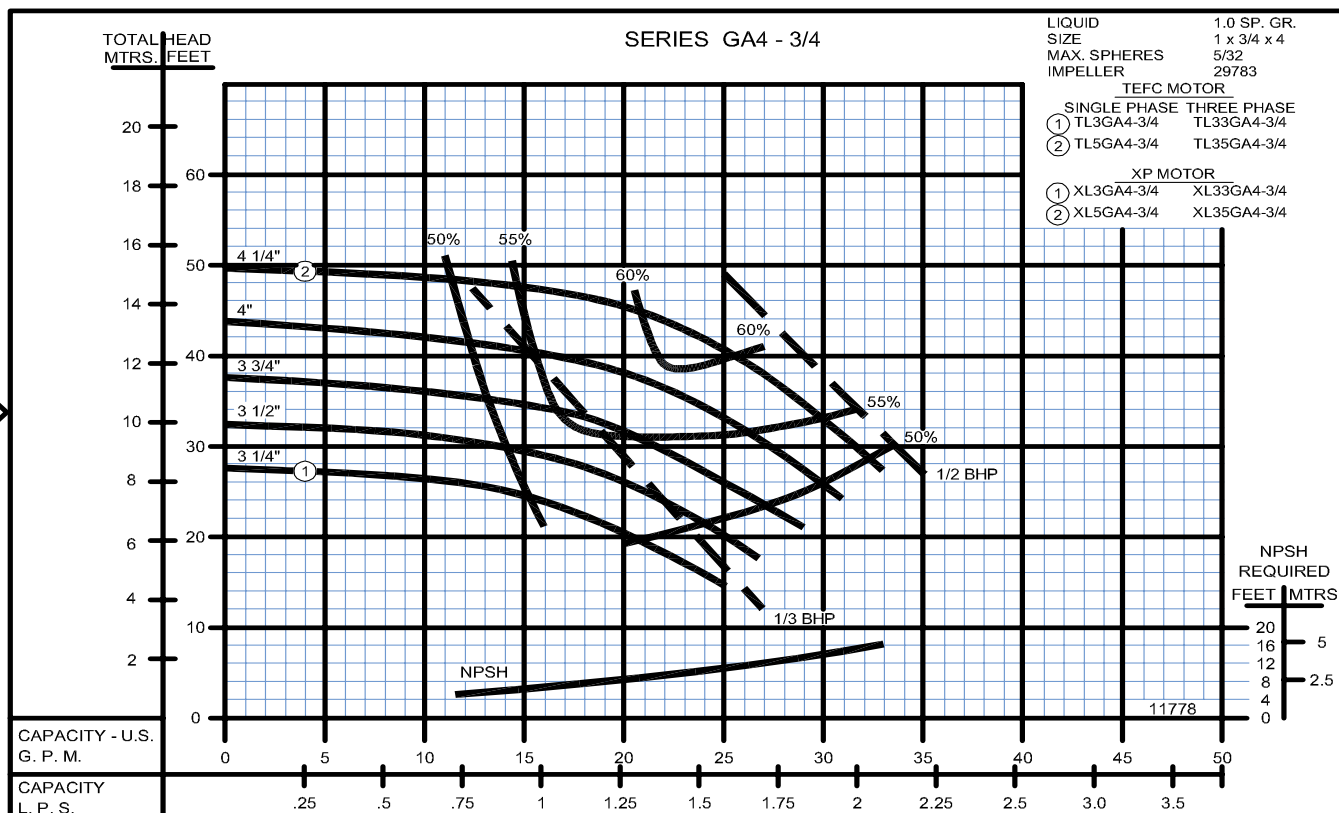

SECTION 2A
PAGE 8
DATE 1/06



PUMPS & SYSTEMS

A Crane Co. Company

USA: (937) 778-8947 • Canada: (905) 457-6223 • International: (937) 615-3598

Close Coupled Centrifugal Pumps

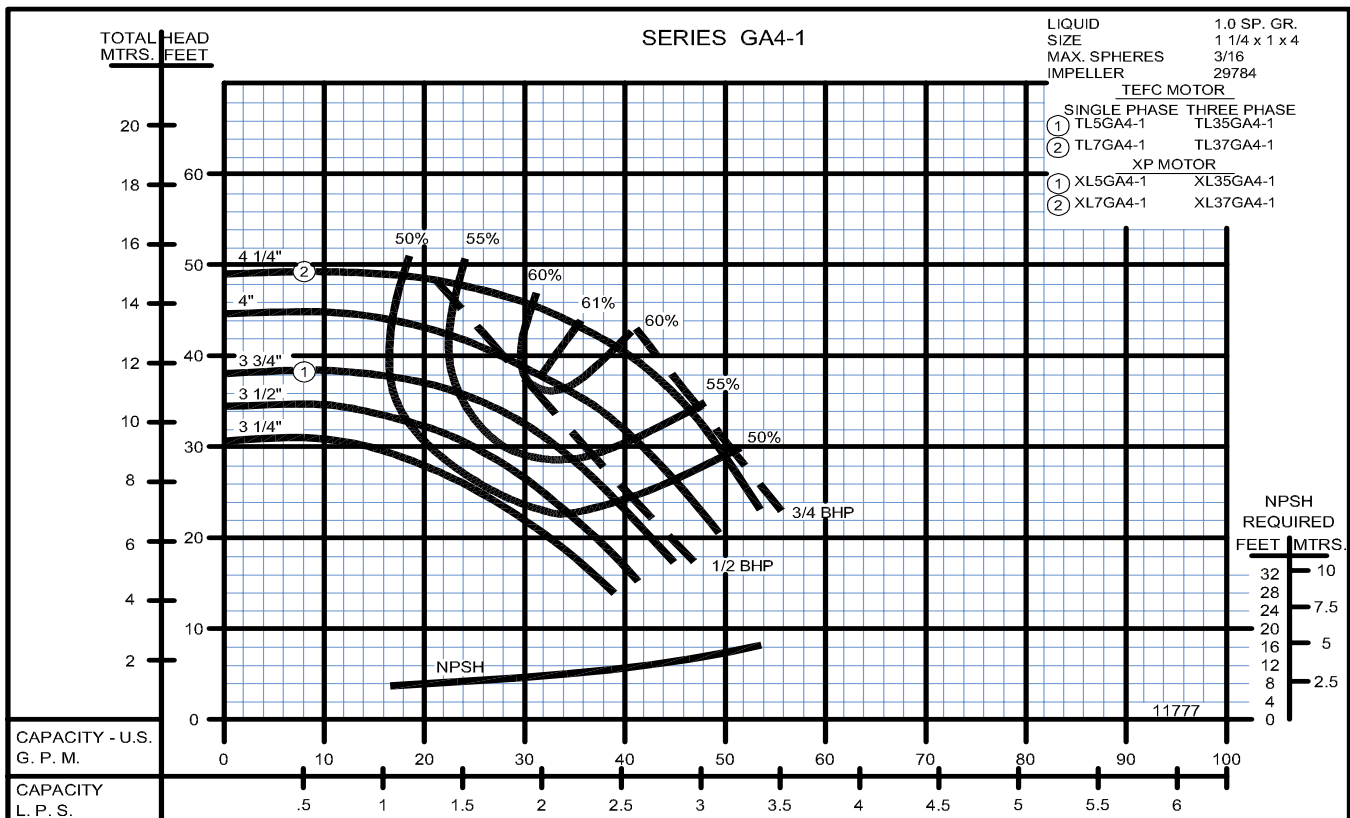
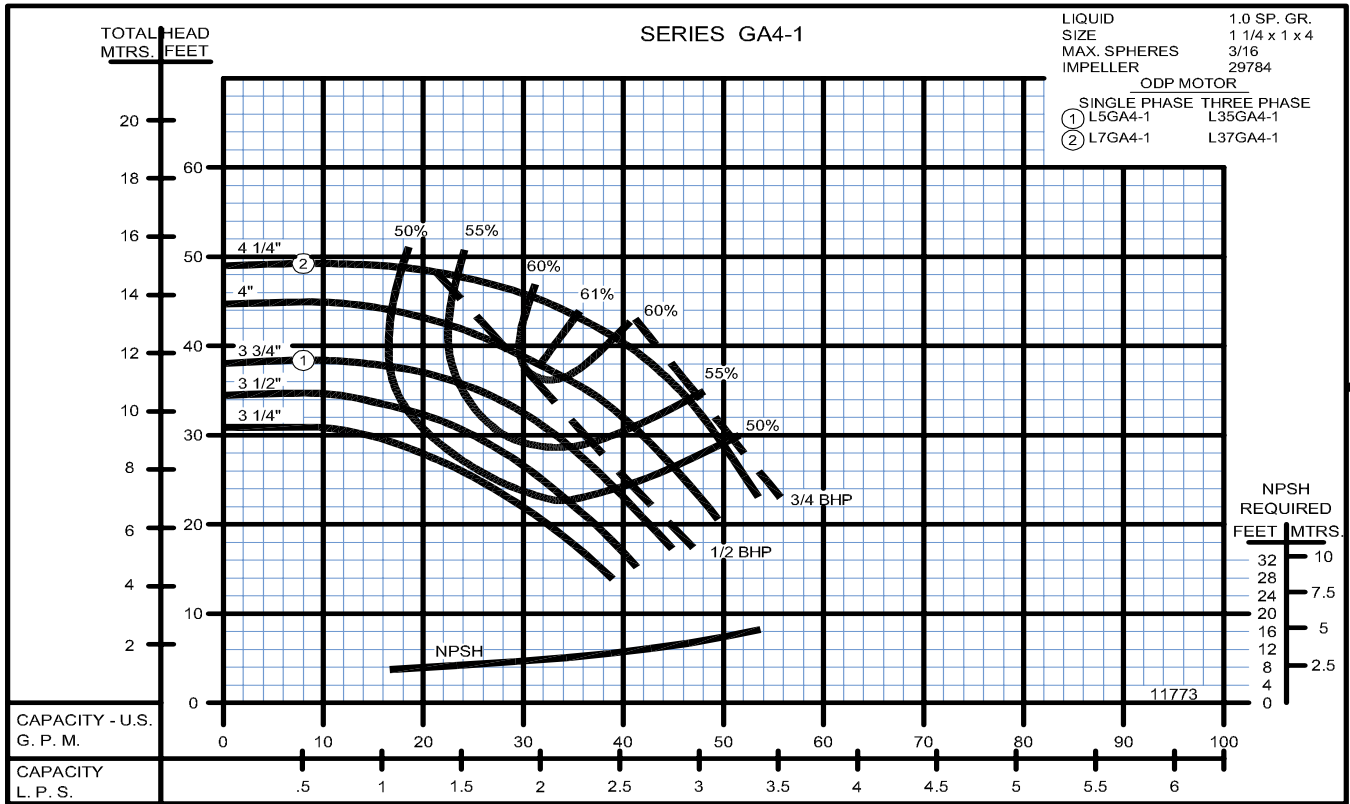

Close Coupled Centrifugal Pumps

2900 RPM

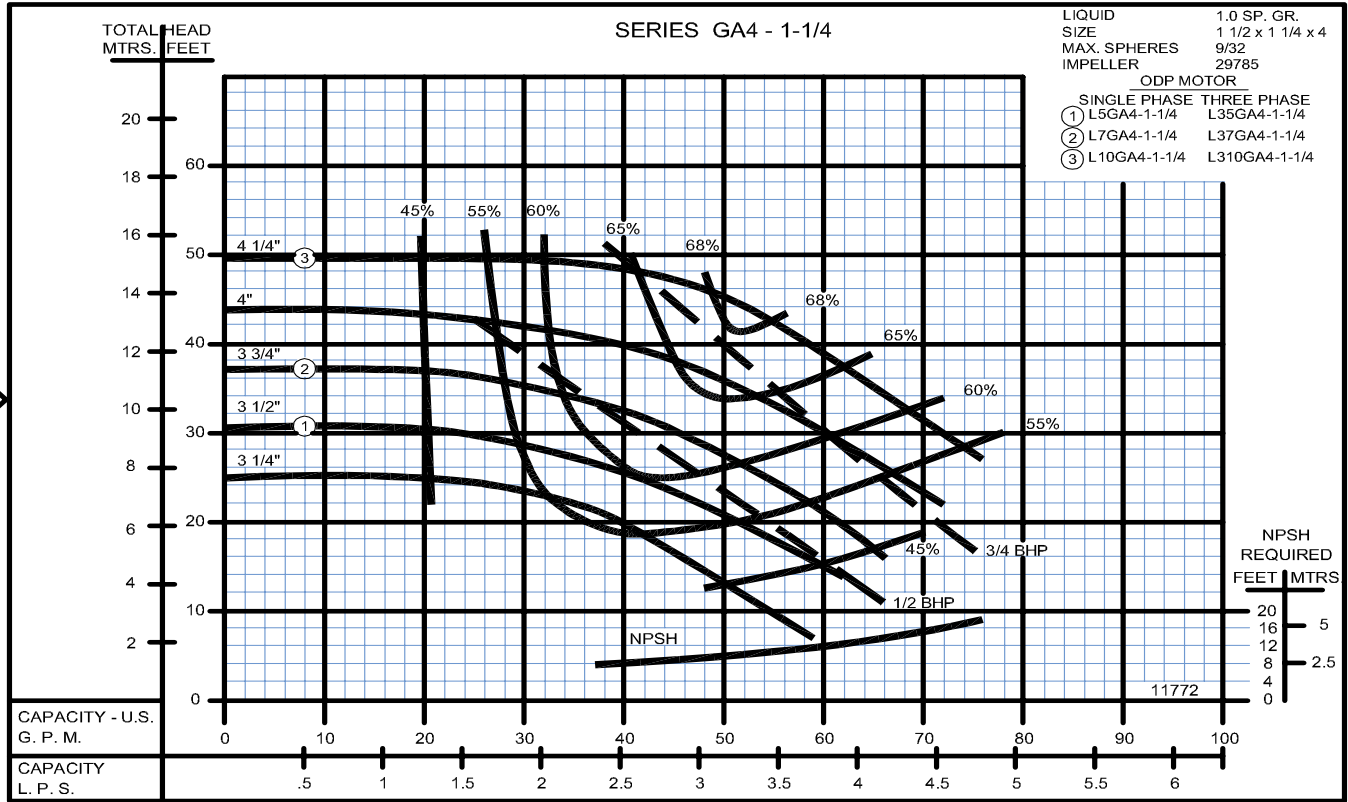

2900 RPM

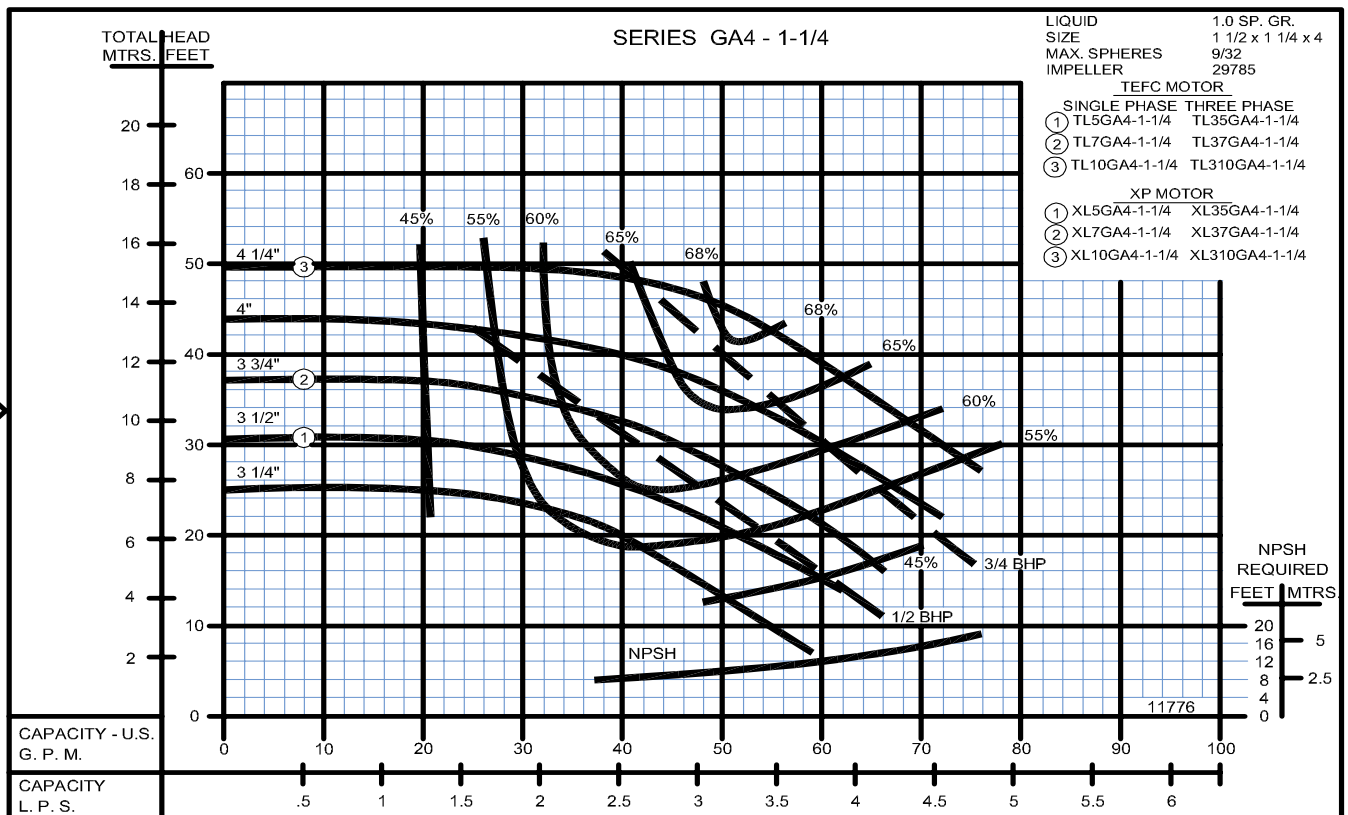

Close Coupled Centrifugal Pumps

