

END-SUCTION CENTRIFUGAL PUMPS

Series: BCSF
3 - 20 HP @ 3500 RPM
0.5 - 5 HP @ 1750 RPM
1 & 3 phases



SUCTION

2" or 3" horizontal.

DISCHARGE

1½" or 2" vertical.

MAX. WORKING PRESSURE

175 PSIG.

MAX. TEMPERATURES

250°F (121°C).

BODY

AISI 316 stainless steel.

FLANGES

Standard flange connections conforming to 150 lbs. ANSI drilling.

INTERMEDIATE COUPLING

Cast iron.

IMPELLER

Design: closed.

Material: AISI 316 stainless steel.

SEAL

Design: mechanical, type 12.

Material: carbon/silicon-carbide faces, Viton elastomers and 316 stainless steel metal parts.

SEAL PLATE

AISI 316 stainless steel.

SHAFT SLEEVE

AISI 316 stainless steel.

O-RINGS

Viton.

MOTOR

NEMA standard JM shaft extension from 3 to 20 HP at 3500 RPM and 0.5 to 5 HP at 1750 RPM. Single phase motors are 115/208–230 V. Three phase motors are 208–230/460V.

Overload protection must be provided.

HARDWARE

AISI 304 stainless steel.

PAINT

Solvent based enamel (only intermediate coupling).

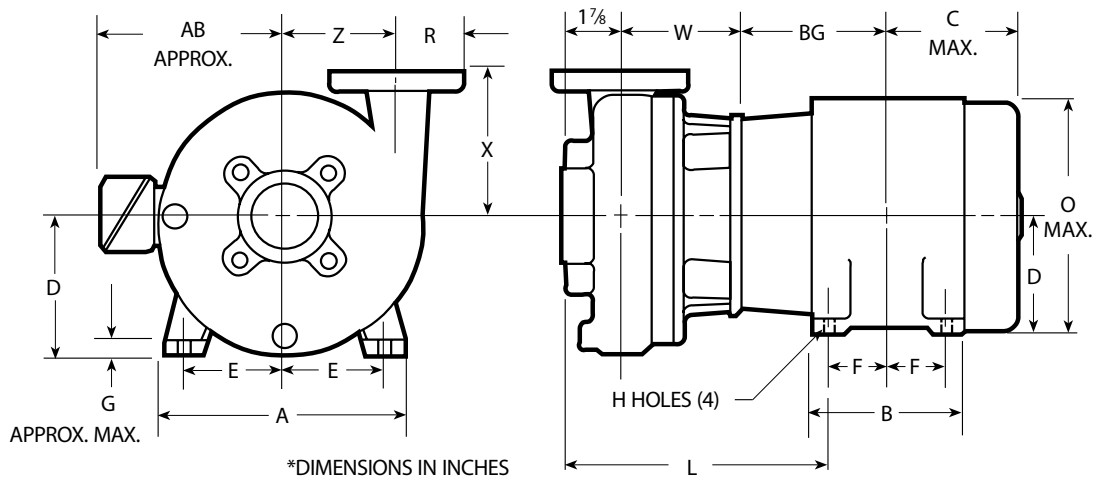

Liquid End Dimensions and Weights

MODEL	SIZE	DIMENSIONS					WEIGHT PUMP
		D	W	X	R	Z	
BCSF 1½ x 2-6	1½ x 2	4 ⁷ / ₃₂	4¼	5	2½	3½	35
BCSF 1½ x 2-8	1½ x 2	5¼	4¼	5½	2½	4¼	50
BCSF 2 x 3-7	2 x 3	5¼	4¼	6	3	4¼	50

(All dimensions are in inches and weight in pounds. Do not use for construction purposes.)

NOTE: Calculate total approximate weight by adding pump and motor weights.

Motor Frames

FRAME	MOTOR HORSEPOWER			
	SINGLE PHASE		THREE PHASE	
	ODP	TEFC	ODP	TEFC
145 JM	--	--	3	--
182 JM	3	--	5	3
184 JM	5	3	7½	5
213 JM	--	5	10	7½
215 JM	--	--	15	10/15
254 JM*	--	--	20	20
256 JM*	--	--	25	20

* With 215 JM shaft extension.

(ODP = Open Drip Proof)

(TEFC = Totally Enclosed Fan Cooled)

Motor Dimensions and Weights

FRAME JM	A	AB	B	BG	C MAX.	D	E	F	G	H	L	O MAX.	SINGLE PHASE		THREE PHASE	
													ODP	TEFC	ODP	TEFC
145	7	5 ⁷ / ₈	6	5 ³ / ₈	6 ¹ / ₈	3½	2 ³ / ₄	2½	7/16	11/32	9	7¼	--	--	39	--
182	9	8 ¹ / ₈	5 ³ / ₄	5 ⁷ / ₈	6 ³ / ₄	4½	3 ³ / ₄	2¼	9/16	13/32	9 ⁵ / ₈	9¼	75	--	69	62
184			6 ³ / ₄	6 ³ / ₈	7¼			2 ³ / ₄					90	82	78	74
213	10½	9 ¹ / ₁₆	7	7¼	8	5¼	4¼	2 ³ / ₄	5/8	13/32	10 ⁵ / ₈	11¼	--	124	114	117
215			8½	8	8 ³ / ₄								3½	--	--	136
254	12 ³ / ₈	10 ¹¹ / ₁₆	10½	9 ¹ / ₈	10	6¼	5	4 ¹ / ₈	17/32	10 ⁷ / ₈	13 ⁵ / ₃₂	--	--	205	256	--
256			12	10	10 ³ / ₄			5						--	--	221

(All dimensions are in inches and weight in pounds. Do not use for construction purposes.)

Pumps will be shipped with top vertical discharge position as standard. For other orientations remove casing bolts, rotate discharge to desired position, replace and tighten bolts to 35 lbf-ft. Discharge may extend below motor mounting surface when using bottom horizontal position; adequate clearance must be provided. Standard casing will not be drilled and tapped for drain plugs; if tappings for 1/4" NPT drain plugs are required, order as options.

IMPORTANT!

1. Never use this pump to handle explosive liquids.
2. This pump is not approved to be used in swimming pools, recreational installations or any application where human contact may be common.
3. Testing is performed with water specific gravity of 1.0 @ 68°F (20°C); other fluids may vary performance.

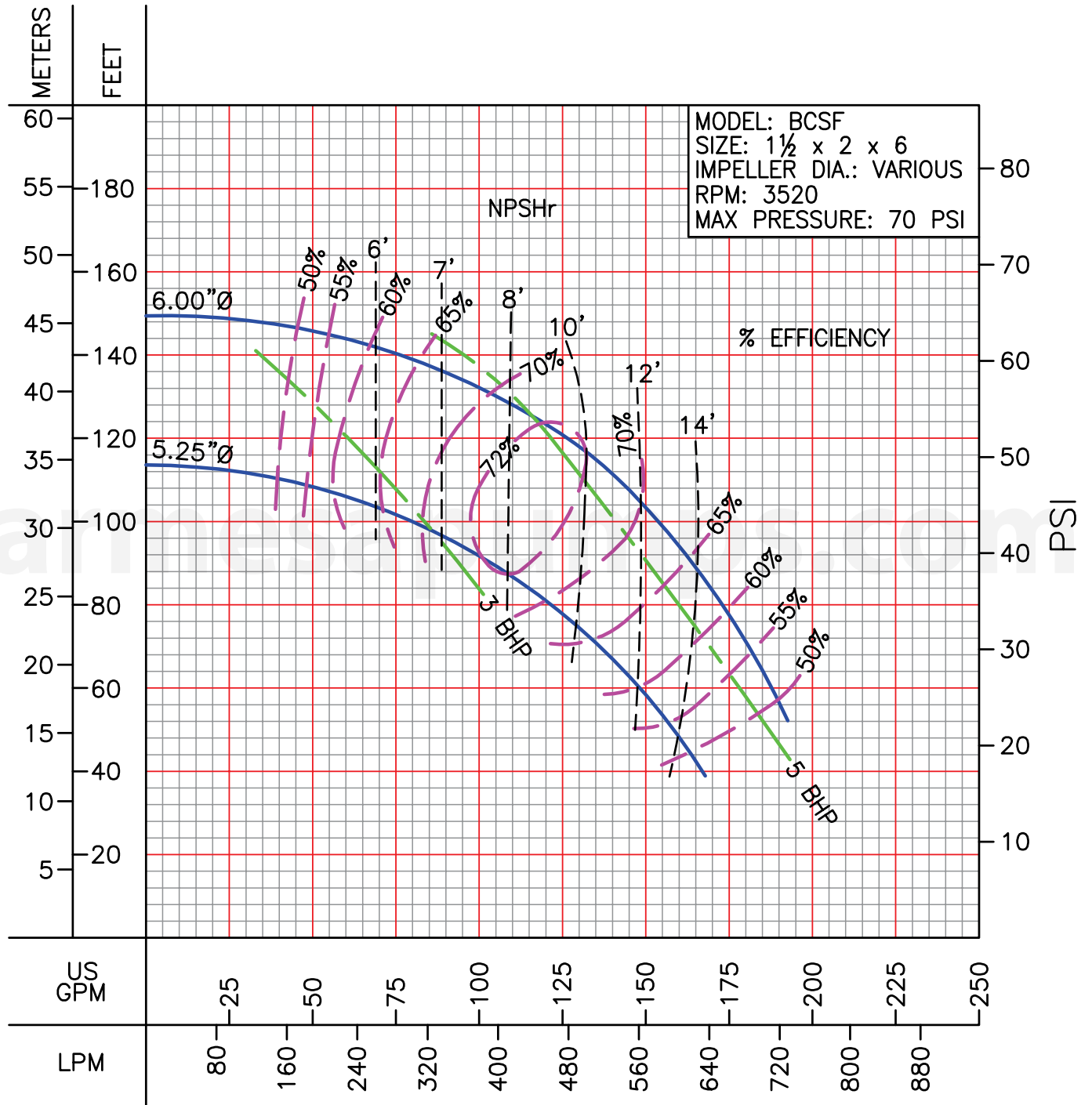

LIQUID: WATER
SPECIFIC GRAVITY: 1.00

TEMPERATURE: 70° F (21° C)
MAXIMUM DIA. SOLIDS: .38" in

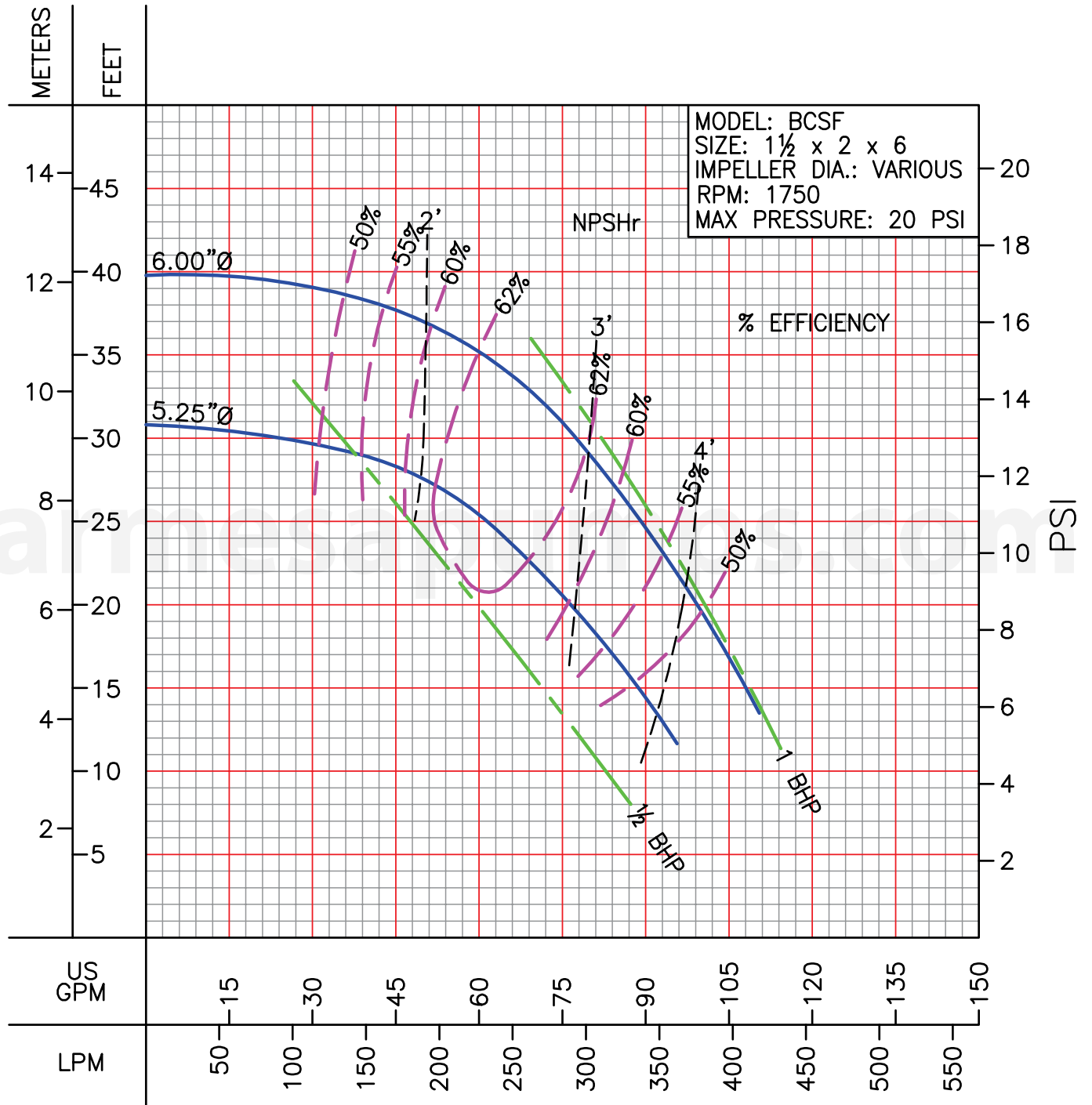

LIQUID: WATER
SPECIFIC GRAVITY: 1.00

TEMPERATURE: 70° F (21° C)
MAXIMUM DIA. SOLIDS: .38" in

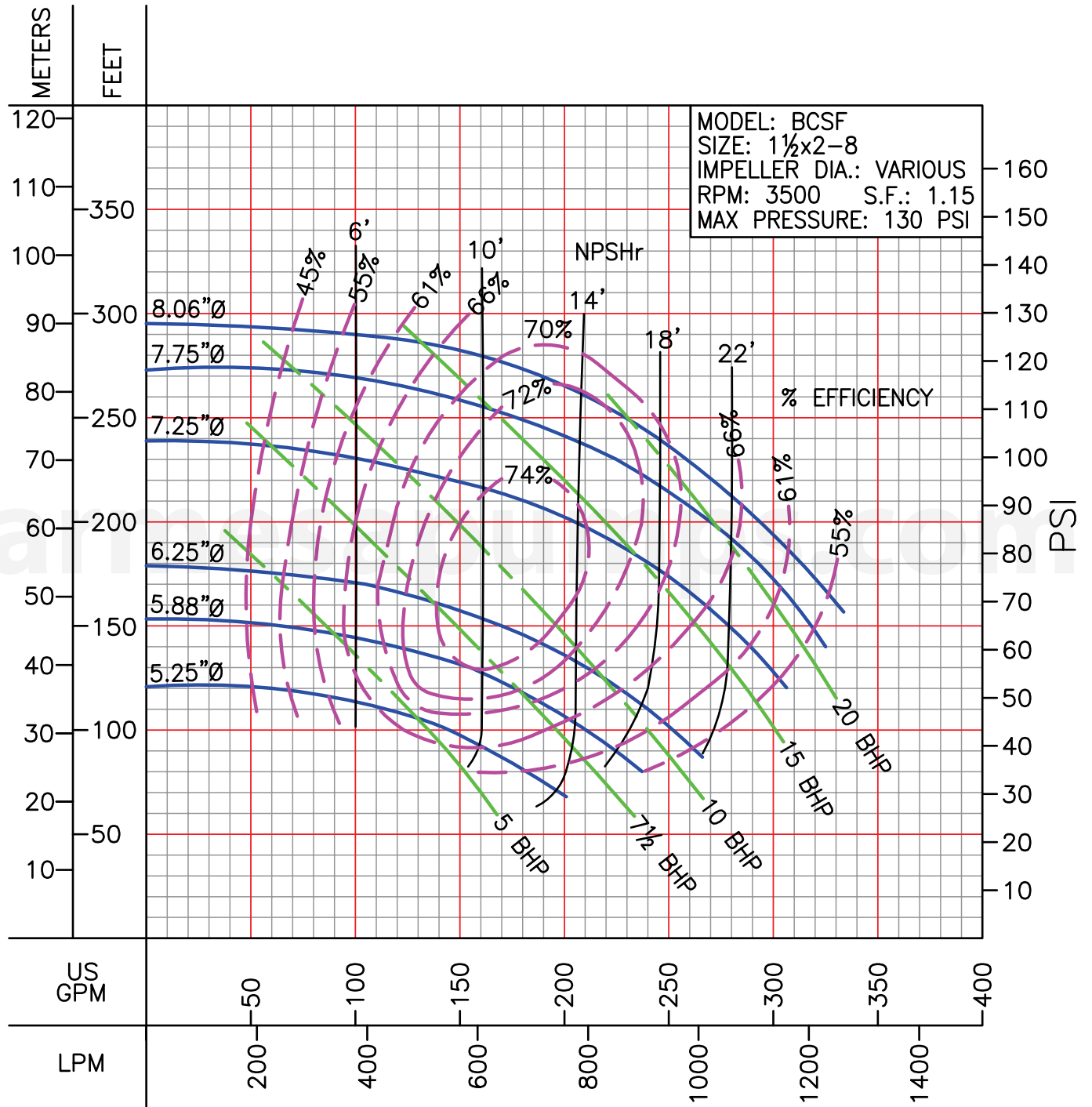

MODEL: BCSF
SIZE: 1½x2-8
IMPELLER DIA.: VARIOUS
RPM: 3500 S.F.: 1.15
MAX PRESSURE: 130 PSI

LIQUID: WATER
SPECIFIC GRAVITY: 1.00

TEMPERATURE: 70° F (21° C)
MAXIMUM DIA. SOLIDS: .38" in

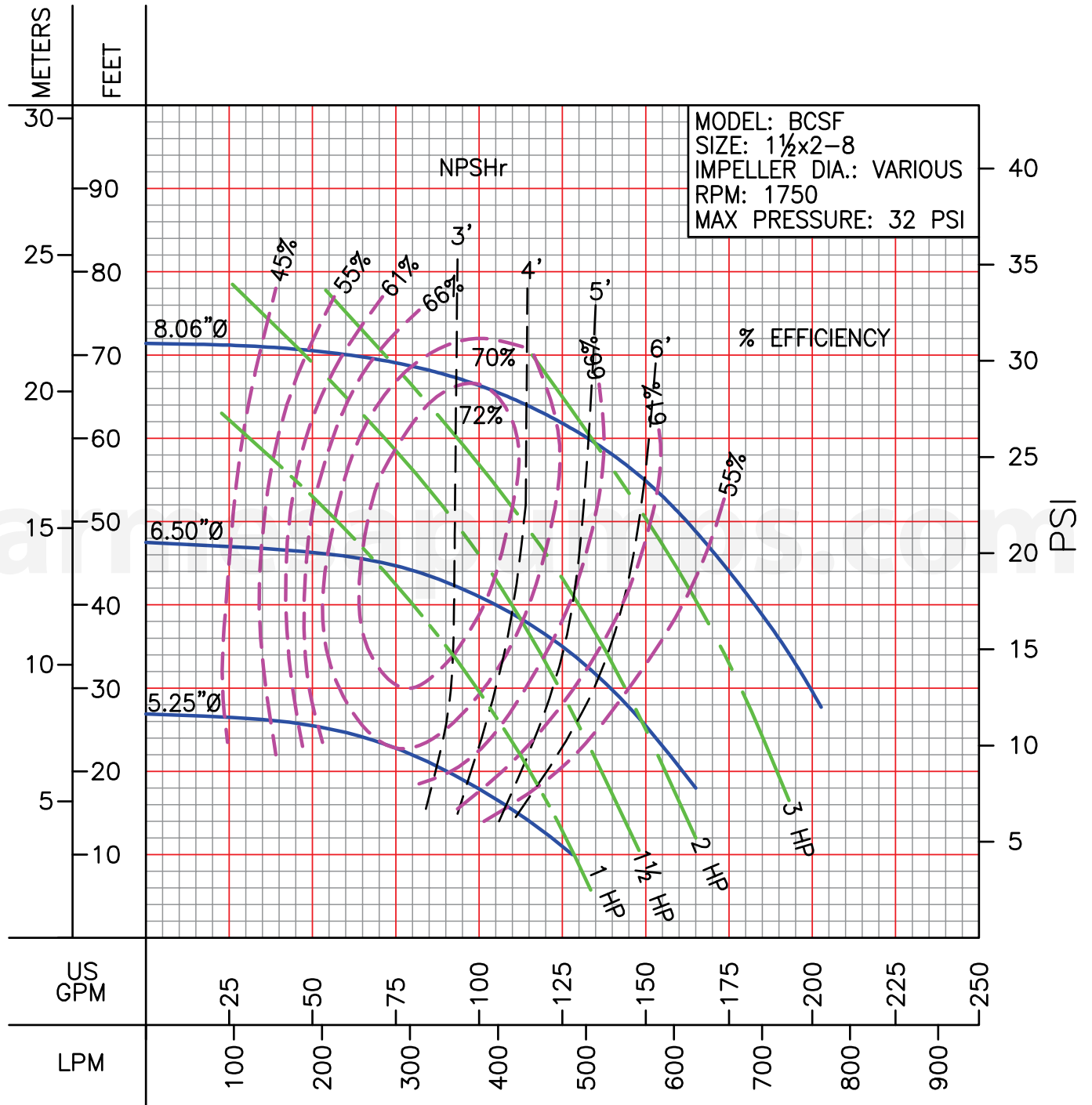

MODEL: BCSF
SIZE: 1½x2-8
IMPELLER DIA.: VARIOUS
RPM: 1750
MAX PRESSURE: 32 PSI

LIQUID: WATER
SPECIFIC GRAVITY: 1.00

TEMPERATURE: 70° F (21° C)
MAXIMUM DIA. SOLIDS: .38" in

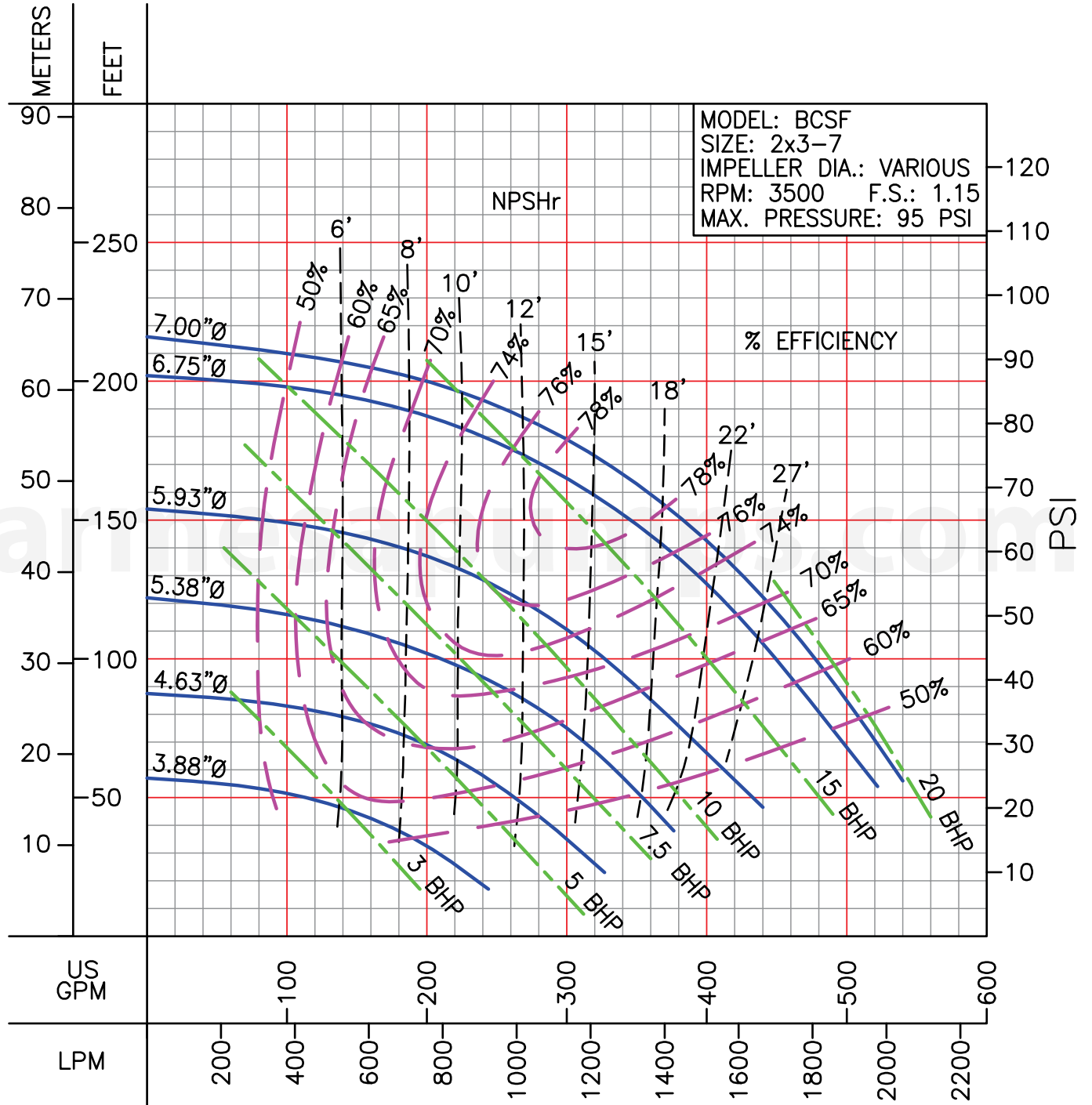

LIQUID: WATER
SPECIFIC GRAVITY: 1.00

TEMPERATURE: 70° F (21° C)
MAXIMUM DIA. SOLIDS: .56" in

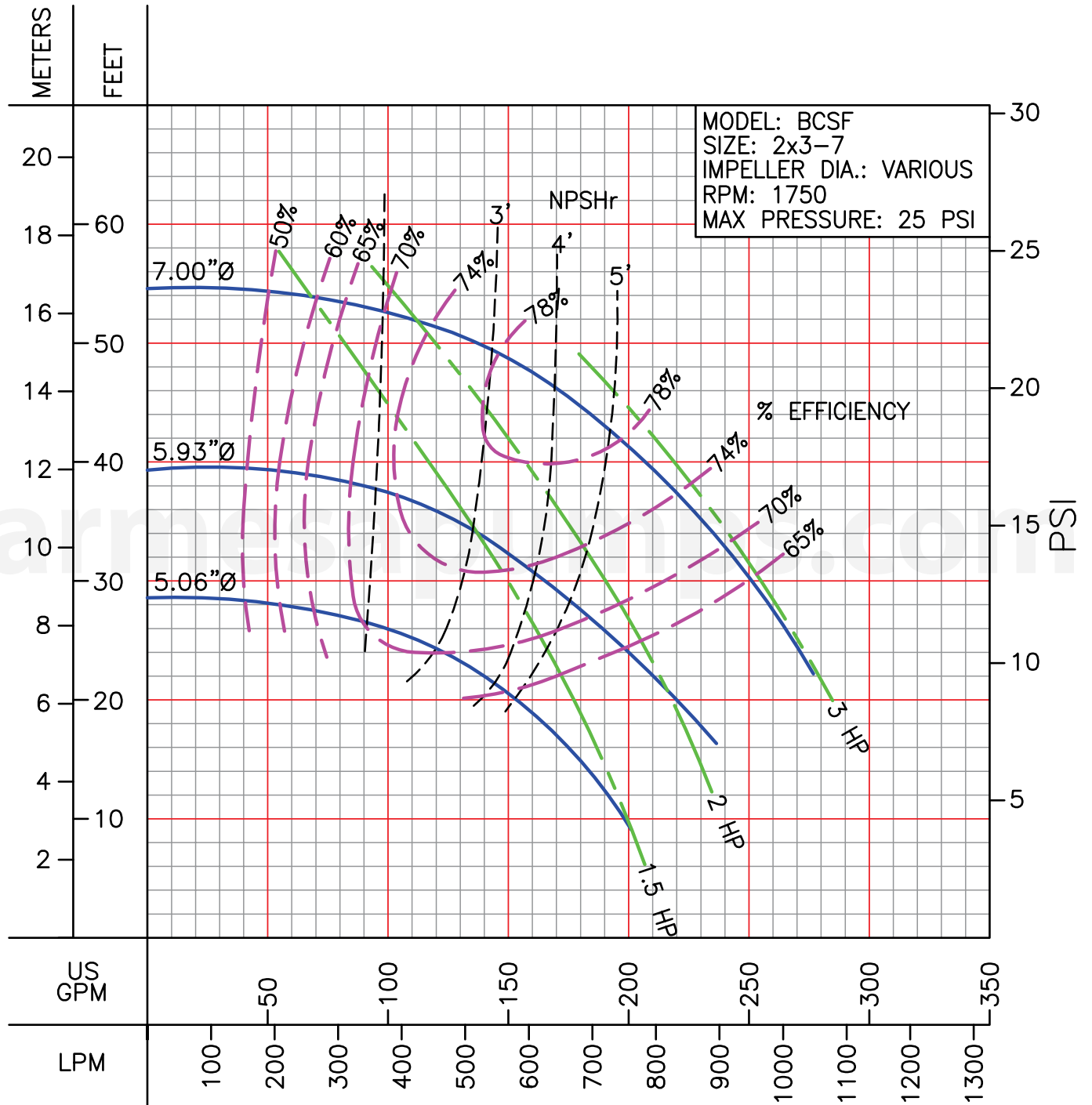

MODEL: BCSF
SIZE: 2x3-7
IMPELLER DIA.: VARIOUS
RPM: 1750
MAX PRESSURE: 25 PSI

LIQUID: WATER
SPECIFIC GRAVITY: 1.00

TEMPERATURE: 70° F (21° C)
MAXIMUM DIA. SOLIDS: .56" in