

# SUBMERSIBLE DEWATERING PUMP

Series: KTM  
Model: 3KTM503 / 3KTM504  
5 HP / 3450 RPM  
Discharge: 3"



## DISCHARGE

3" vertical for hose coupling. Cast iron ASTM A-48 class 30.

## LIQUID TEMPERATURE

104°F (40°C)

## UPPER COVER

Cast iron ASTM A-48 class 30.

## PUMP BODY

Cast iron ASTM A-48 class 30.

## MOTOR HOUSING

Cast iron ASTM A-48 class 30.

## IMPELLER

**Design:** semi-open.

**Material:** high chrome alloy.

## INLET PLATE

Ductile iron.

## SHAFT

420 AISI stainless steel.

## HARDWARE

304 series stainless steel.

## O-RINGS

Nitrile rubber (NBR).

## PAINT

Air dry enamel, water based.

## SEAL

**Design:** double mechanical, oil filled chamber.

**Material:** SiC-SiC / carbon-SiC. Stainless steel hardware.

## CORD ENTRY

50 ft of neoprene cord, sealed against moisture.

## MOTOR

Three phase induction motor, 230 & 460 volts, 60 Hz, 3450 RPM. Insulation class F and IP68 protection class.

## STRAINER

Steel.

## HANDLE

Rubber and steel.

## ACCESSORIES

Includes a discharge adapter for NPT threads.

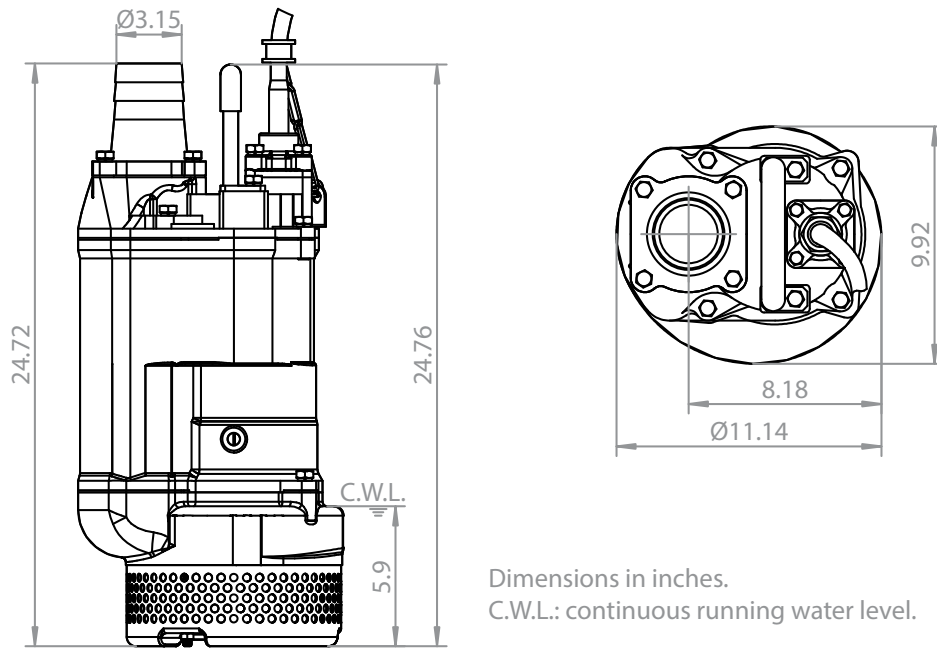

Dimensions in inches.  
C.W.L.: continuous running water level.

MODEL	PART No.	HP	VOLTS	PHASE	RPM (Nominal)	MAX AMPS	WEIGHT (pounds)
3KTM503	70090237	5	230	3	3450	12.2	139
3KTM504	70090238	5	460	3	3450	6.6	139

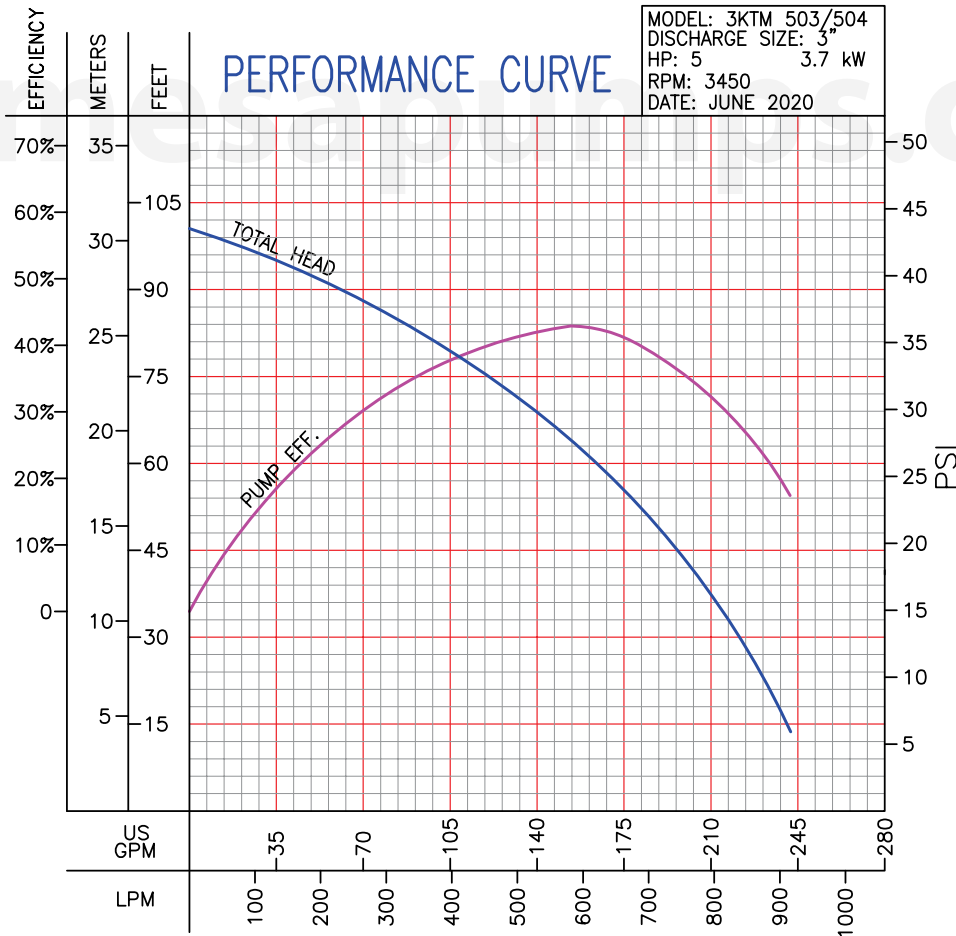

**IMPORTANT!**

1. Never use this pump to handle explosive liquids.
2. This pump is not approved to be used in swimming pools, recreational installations or any application where human contact may be common.
3. Testing is performed with water specific gravity of 1.0 @ 68 °F (20 °C); other fluids may vary performance.