

Ampco Pumps Company

ZP Series Positive Displacement Pumps

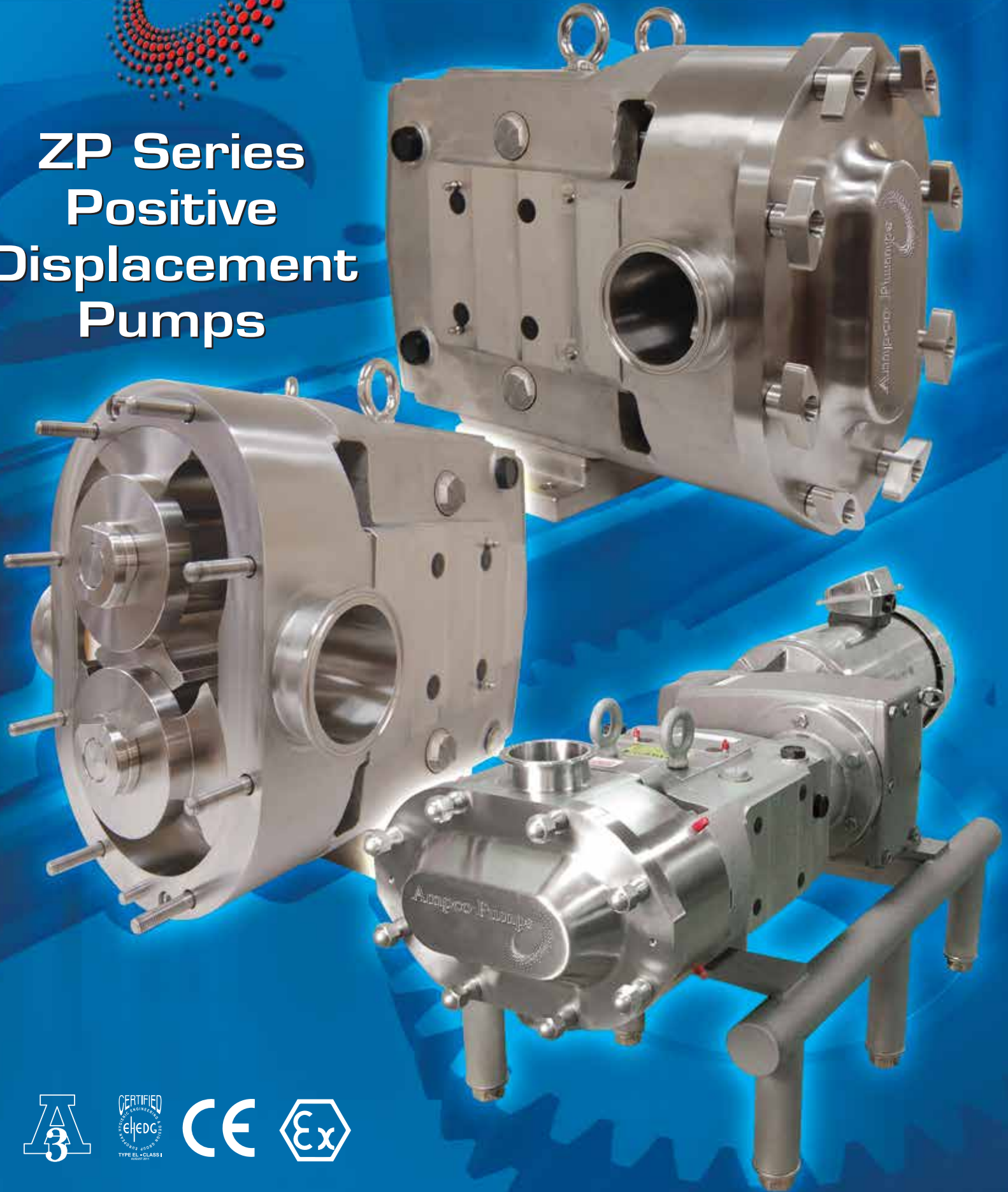

ZP SERIES PUMPS - Redefining Engineered Excellence

In 2010, Ampco introduced the ZP1 and ZP2 Series of positive displacement pumps. The ZP Series offers more standard features than the competition including a stainless steel gearcase. ZP1 and ZP2 Series pumps are part-for-part, 100% interchangeable with the competition.

The ZP1/ ZP2 Series set a new standard of value and quality within the market, and Ampco raised the bar in 2012 with the introduction of the ZP3. The patent-pending ZP3 Series is fully CIP-able without modifications and without loss of pump efficiency. The front-loading seal design allows the seal to be easily changed and the rotor case design eliminates all dead zones. In 2013, Ampco introduced the patent-pending ZP1+ Series, which is designed so o-ring seals can be changed without having to disconnect the pump from the piping system. Both the ZP3 and ZP1+ set a new standard for sanitary processing.

The entire ZP Series offers quality, value and proven performance.

Remanufacturing Program:

Ampco offers remanufacturing services for ZP1, ZP2, ZP3 Series pumps and competing models. The pumps are rebuilt with oversized rotors to extend the useful life of the pump. A remanufactured pump includes new shafts, gears, bearings, rotors and a full one-year factory warranty. Pumps can be remanufactured in two weeks and are 30% less than the cost of a new pump.



Available Options:
Rectangular inlets,
heating jackets,
pressure relief valves
and optional rotor designs

PERFORMANCE

- Capacity Range: 0.1 to 310 gpm (0.02 to 70.4 m³/hr)
- Pressure Range: up to 500 psi/ 34 Bar
- Temperature Range: -40°F to +300°F (-40°C to +150°C)
Note: Hot clearances required for high temp operation
- Viscosity Range: 1 to 1,000,000 CPS

ZP1 and ZP2 pumps are dimensionally and hydraulically interchangeable with competing brands. Visit our website at www.ampcopumps.com

All ZP pumps include a stainless steel gear case, providing high-resistance to corrosion and compatibility with caustic agents

All ZP pumps include stainless steel cleanout plugs and splash plate

Solid 17-4ph stainless steel shafts on models 30 and larger, provide twice the tensile strength of 316L

Tapered roller bearings maintain axial forces for equal support in both directions

Stainless steel bearing retainer prevents corrosion and enhances bearing protection

Alloy 88 rotors provide non-galling characteristics to maintain tight tolerances. Optional clearances available

Helical timing gears for increased load carrying capacity and reduced noise

Separate oil chamber for gears using anti-microbial lube

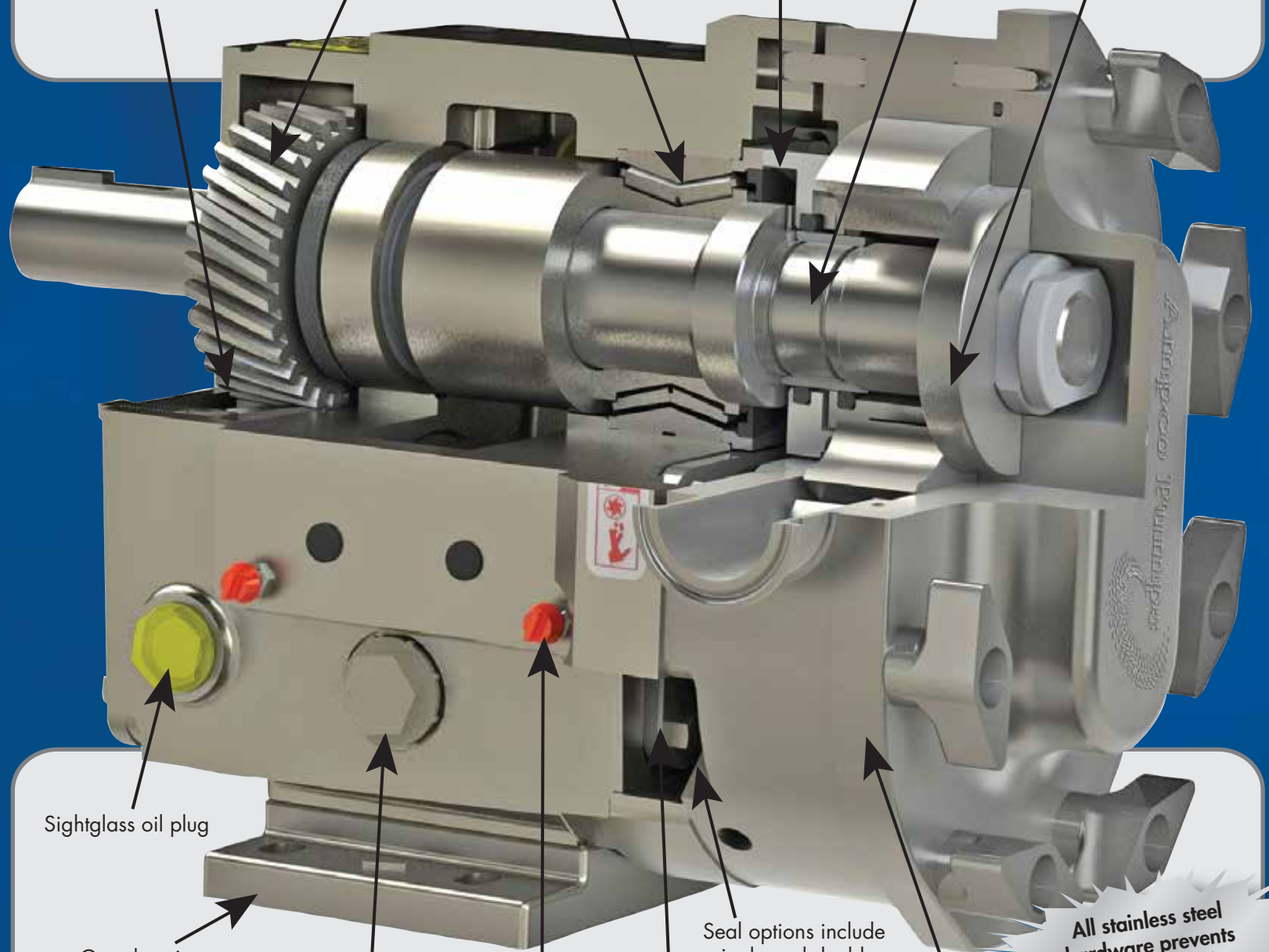

Sightglass oil plug

Gear housing designed to mount pump in four positions:

- Side mount left hand
- Side mount right hand
 - Lower drive
 - Upper drive

Stainless steel sealed cleanout plugs protect and extend bearing life

Threaded grease fitting for easy replacement

Stainless steel splash plate protects the face of the bearing seal from cleaning solutions and product

Seal options include single and double mechanical seals, o-ring seals and lip seals

Pump housing and cover are constructed of 316L stainless steel

All stainless steel hardware prevents corrosion and stripped bolts

ZP3

Ampco Pumps Company

The Best Choice for Sanitary Processing

**Ampco's ZP3 Series is
CIP-able without
modifications
and loss of efficiency**

**Patent-pending front-
loading seal design
reduces maintenance
time and costs**

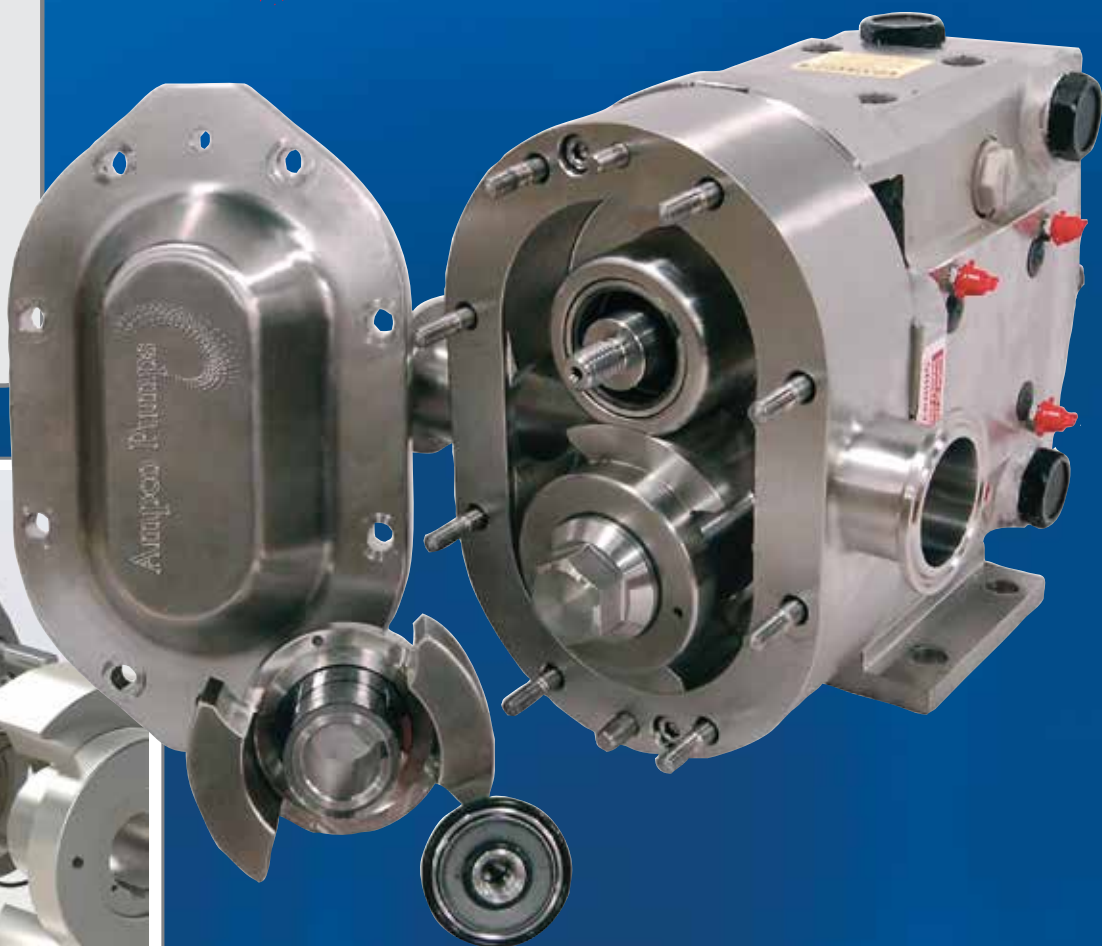
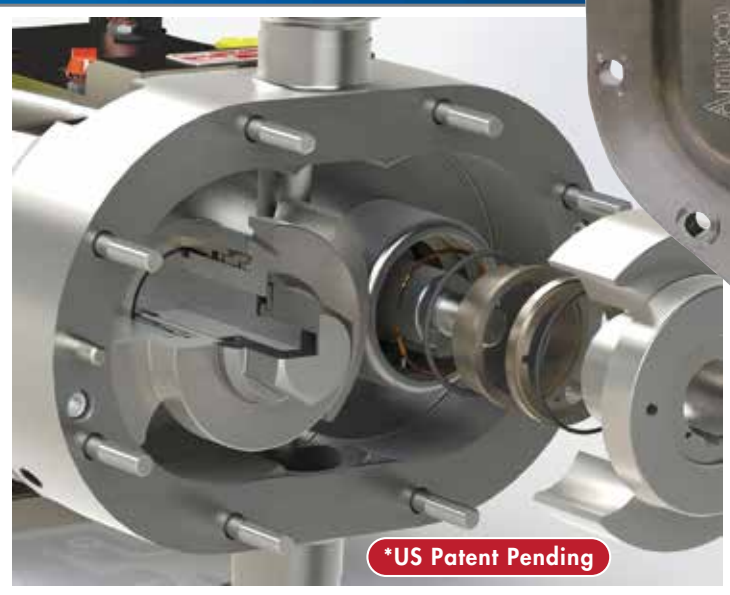

ZP3 Series Features

- Front-loading seals are located closer to the product flow, offering improved CIP-ability with no disassembly required.
- Front-loading seals allow for ease-of-maintenance and reduced service time.
- EHEDG Certified and in conformance with 3A Sanitary Standards and the ATEX Directive.
- Cover design maximizes exposure of the cover o-ring to the CIP fluid.
- Free drain design improves CIP-ability while maintaining maximum pump efficiency.
- CIP holes in rotor ensure turbulent flow to the cover hub.
- Elimination of dead zones in shaft bore improves cleanability and increases seal life.
- The ZP3 pump is mounted on a ZP2 gear case, including shafts, to maximize parts interchangeability.
- Existing ZP2 pumps (and our competitors' similar pumps) can be upgraded to the ZP3 design with new rotors, seals and re-machining the existing rotor case.
- New pumps can be reconditioned 2 to 3 times.

For additional information on the ZP3 series and other Ampco products,
please visit www.ampcopumps.com.



ZP3 Performance

SAMPLE ZP3 COMPARISION CURVES

Ampco ZP3-30

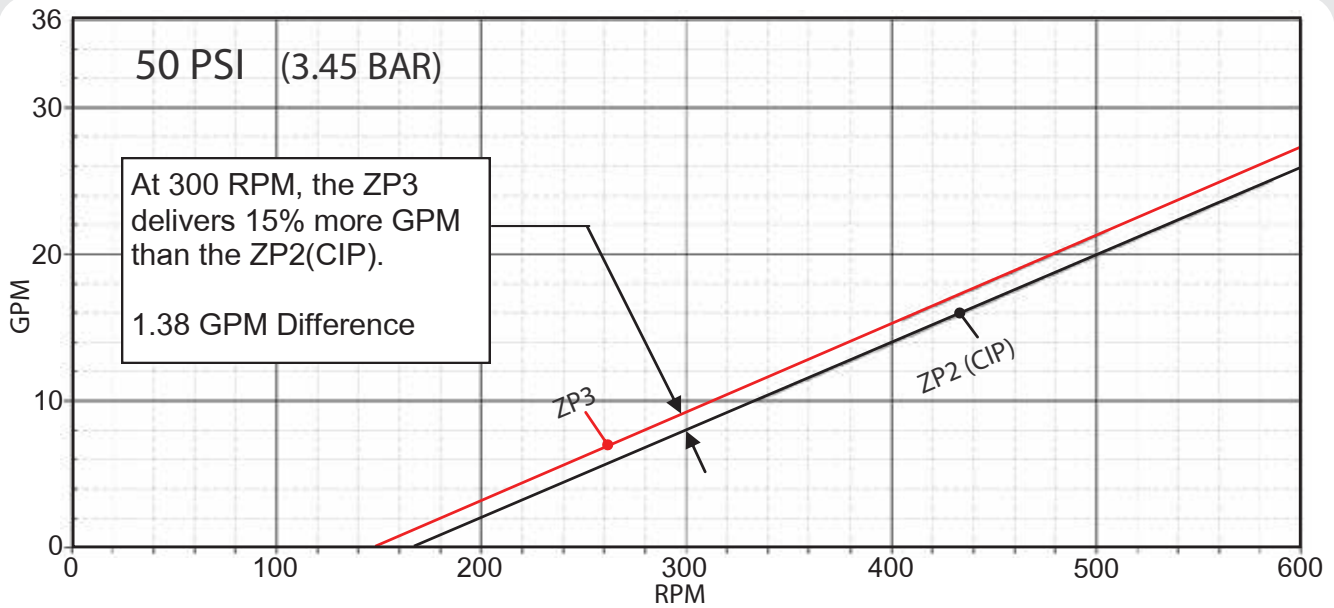

Ampco ZP3-130

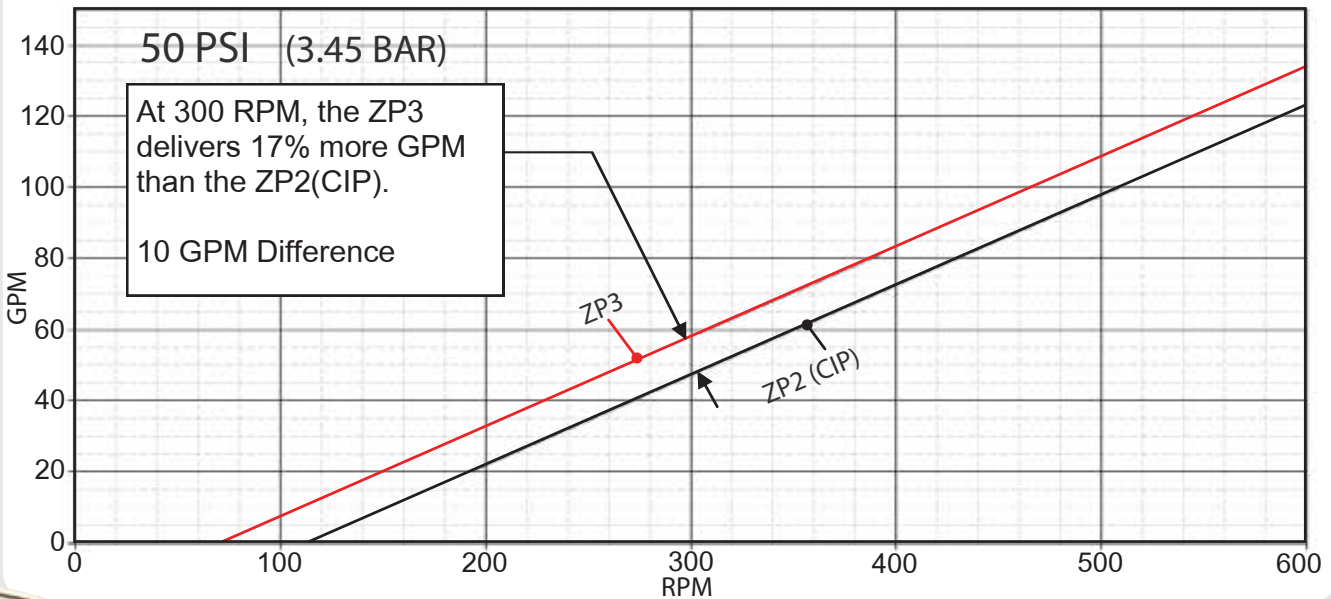

Ampco ZP Series Advantages

Only Ampco ZP pumps offer all of these upgrades at no additional charge

- Stainless steel gearcase
- Stainless steel retainers
- 17-4ph shafts
- Helical gears
- 4-way mounting
- 2-side threaded grease zerks
- Anti-microbial lube
- 6 oil fill plugs with sight glass
- Gasketed stainless steel cleanout plugs and splash plate

ZP1+ Series

Ampco continues to bring innovation to the sanitary pump market. We have enhanced the traditional design of the popular ZP1 pump and are pleased to introduce the ZP1+ (available in models 30 and larger) for ease of maintenance and reduced downtime.



**Patent-
Pending**
ZP1+
**EASY
MAINTENANCE
AND
REDUCED
DOWNTIME**



AMPCO ZP1+ DESIGN

The patent-pending design changes the position of the static and dynamic o-ring, allowing replacement without having to disconnect the pump from the piping system, providing easy maintenance and reduced downtime. The secondary sleeve and assembly will seal the pump if the rotors are removed for CIP processing.

REMANUFACTURING OPTION

Existing ZP1 pumps (and competing models) can be converted to a ZP1+ pump during the remanufacturing process at no extra charge.



ZP1 / ZP2 / ZP3 APPLICATIONS

BAKERY

dough • fats • fruit filling • icing • oils • yeast

BEVERAGES

fruit concentrate • fruit juices • beer • mash

CANDY

chocolate • cocoa butter • corn syrup • gelatin • sugars

CANNED FOODS

baby food • jams • jellies • mayonnaise • potato salad • pudding • relish • stews

COSMETICS

creams • emulsions • jellies • lotions • shampoo • toothpaste

DAIRY

soft cheese • butter • milk • cream • margarine • ice cream • yogurt • curds

DRESSINGS

mayonnaise • sauces

FLAVORINGS

concentrates • syrups

INDUSTRIAL

auto paint • inks • latex • polymers

MEATS

broth • fats • gelatin • pet foods • sausage fillings

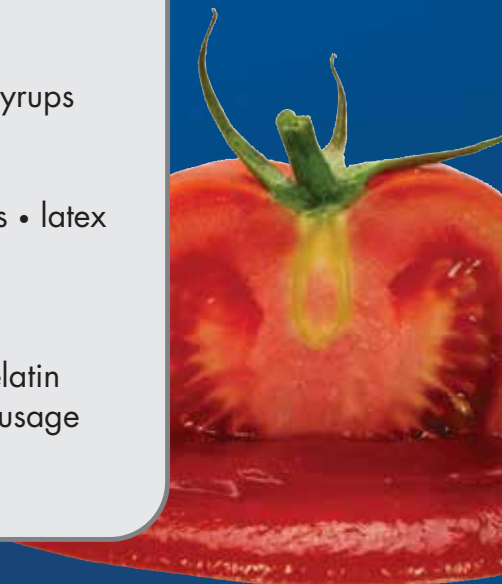

Ampco Pumps
Company 

Ampco Pumps Company
2045 West Mill Road
Glendale, WI 53209 USA
Phone: 800.737.8671
Fax: 414.643.4452
www.ampcopumps.com

Ampco Pumps GmbH
Am Gäxwald 6
76863 Herxheim Germany
Phone: +49 7276 5058515
Fax: +49 7276 5058517
info@ampcopumps.de

Ampco Pumps
GmbH 

AMPCO ZP PUMP TECHNICAL DATA

ZP1 Model	Nominal Capacity		Displacement		Max. Differential Pressure		Standard Connection Size		Optional Connection Size		Max. Speed	Temperature Range	
	GPM	M ³ /hr	Gallons / rev	Liters / rev	PSI	Bar	in.	mm	in.	mm	Rev / min	°F	°C
	6	7	1.6	.0082	.031	200	13.8	1"	25	1½"	38	800	-40° to 300°
15	10	2.3	.0142	.054	200	13.8	1½"	38	-	-	700		
18	17	3.9	.029	.110	200	13.8	1½"	38	2"	51	600		
30	36	8.2	.060	.227	200	13.8	1½"	38	2"	51	600		
40	46	10.4	.076	.288	150	10.3	2"	51	2½"	64	600		
60	92	20.9	.153	.579	200	13.8	2½"	64	3"	76	600		
130	152	34.5	.254	.961	200	13.8	3"	76	-	-	600		
220	313	71.1	.522	1.976	200	13.8	4"	102	-	-	600		
320	452	103	.754	2.854	200	13.8	6"	152	-	-	600		
323	370	84	.616	2.332	225	15.5	6"	152	-	-	600		

ZP1 Model	Nominal Capacity		Displacement		Max. Differential Pressure		Rec. Inlet (W x L)		Outlet		Max. Speed	Temperature Range	
	GPM	M ³ /hr	Gallons rev	Liters / rev	PSI	Bar	inches	mm	in.	mm	Rev/min	°F	°C
34	24	5.5	.060	.227	200	13.8	1.75 x 6.75	44 x 171	2"	51	400	-40° to 300°	-40° to 149°
64	61	13.9	.153	.579	200	13.8	2.24 x 8.82	57 x 224	2½" (3")	64 (76)	400		
134	102	23.2	.254	.961	200	13.8	2.97 x 9.25	75 x 235	3"	76	400		
224	208	47.2	.521	1.972	200	13.8	3.87 x 11	98 x 279	4"	102	400		

ZP2/ZP3 Model	Nominal Capacity		Displacement		Max. Differential Pressure		Standard Connection Size		Optional Connection Size		Max. Speed	Temperature Range	
	GPM	M ³ /hr	Gallons / rev	Liters / rev	PSI	Bar	in.	mm	in.	mm	Rev / min	°F	°C
	6	8	1.8	.0082	.031	300	20.7	1"	25	1½"	38	1000	-40° to 300°
15	11	2.5	.0142	.054	250	17.2	1½"	38	-	-	800		
18	20	4.5	.029	.110	200	13.8	1½"	38	2"	51	700		
30	36	8.2	.060	.227	250	17.2	1½"	38	2"	51	600		
40	46	10.4	.076	.288	150	10.3	2"	51	2½"	64	600		
45	59	13.4	.098	.371	450	31.0	2"	51	-	-	600		
60	92	20.9	.153	.579	300	20.7	2½"	64	3"	76	600		
130	152	34.5	.254	.961	200	13.8	3"	76	-	-	600		
180	228	51.8	.380	1.438	450	31.0	3"	76	-	-	600		
220	313	71.1	.522	1.976	300	20.7	4"	102	-	-	600		
210	301	68.4	.502	1.900	500	34.5	4"	102	-	-	600		
320	452	103	.754	2.854	300	20.7	6"	152	-	-	600		

ZP2 Model	Nominal Capacity		Displacement		Max. Differential Pressure		Rec. Inlet (W x L)		Outlet		Max. Speed	Temperature Range	
	GPM	M ³ /hr	rev	Liters / rev	PSI	Bar	inches	mm	in.	mm	Rev/min	°F	°C
34	24	5.5	.060	.227	250	17.2	1.81 x 6.84	46 x 174	2"	51	400	-40° to 300°	-40° to 149°
64	61	13.9	.153	.579	300	20.7	2.44 x 9.0	62 x 229	2½" (3")	64 (76)	400		
134	102	23.2	.254	.961	200	13.8	3.19 x 9.38	81 x 238	3"	76	400		
224	208	47.2	.521	1.972	300	20.7	4.06 x 11.25	103 x 286	4"	102	400		

Please visit www.ampcopumps.com for individual pump curves and dimensional drawings.

ZP1 Dimensions

ZP1 Model		A	B	C	D	E	F	G	H	I	J	K	L	M	N	PORT SIZE	P	Q	KEY +0.002 -0.000	R	S	OAH	Weight
6	inches	4.75	1.95	3.75	12.04	5.50	1.94	2.31	.41, SLOT	6.82	2.93	9.61	2.12	2.00	4.21	1"	2.79	0.875	0.1875	3.49	6.97	8.30	lb. 60
	mm	121	50	95	306	140	49	59	10, SLOT	173	74	244	54	51	107	25	71	22.2	4.76	89	177	211	kg. 27
15	inches	4.75	1.95	3.75	12.04	5.50	1.94	2.31	.41, SLOT	6.82	2.93	9.61	2.12	2.00	4.21	1½"	2.79	0.875	0.1875	3.49	6.97	8.30	lb. 60
	mm	121	50	95	306	140	49	59	10, SLOT	173	74	244	54	51	107	38	71	22.2	4.76	89	177	211	kg. 27
18	inches	4.75	2.18	3.75	12.46	5.50	1.94	2.31	.41, SLOT	6.82	2.93	9.84	2.12	2.00	4.21	1½"	3.02	0.875	0.1875	3.55	7.09	8.30	lb. 64
	mm	121	55	95	316	140	49	59	10, SLOT	173	74	250	54	51	107	38	77	22.2	4.76	90	180	211	kg. 29
30	inches	6.25	2.78	4.25	14.58	6.86	2.31	2.56	.41, SLOT	7.77	3.56	11.61	2.62	2.32	5.21	1½"	3.84	1.25	0.250	4.25	8.50	10.29	lb. 130
	mm	159	71	108	370	174	59	65	10, SLOT	197	90	295	67	59	132	38	98	31.8	6.35	108	216	261	kg. 59
40	inches	6.25	2.94	4.25	14.96	6.86	2.31	2.56	.41, SLOT	7.77	3.56	11.99	2.62	2.32	5.21	2"	4.00	1.25	0.250	4.31	8.62	10.29	lb. 140
	mm	159	75	108	380	174	59	65	10, SLOT	197	90	305	67	59	132	51	102	31.8	6.35	109	219	261	kg. 64
60	inches	8.25	4.14	5.87	18.91	9.56	3.50	4.12	0.53	10.13	5.06	15.14	3.50	2.25	7.31	2½"	5.01	1.625	0.375	5.37	10.75	15.31	lb. 285
	mm	210	105	149	480	243	89	105	13	257	129	385	89	57	186	64	127	41.3	9.53	136	273	389	kg. 129
130	inches	8.25	4.78	5.87	19.85	9.56	3.50	4.12	0.53	10.13	5.06	15.77	3.50	2.25	7.31	3"	5.65	1.625	0.375	5.37	10.75	15.31	lb. 305
	mm	210	121	149	504	243	89	105	13	257	129	401	89	57	186	76	144	41.3	9.53	136	273	389	kg. 138
220	inches	8.50	3.69	9.00	23.37	12.38	3.75	7.25	.53, SLOT	14.05	6.38	18.49	4.50	2.75	9.38	4"	4.44	2.00	0.500	6.63	13.25	19.13	lb. 565
	mm	216	94	229	594	314	95	184	13, SLOT	357	162	470	114	70	238	102	113	50.8	12.70	168	337	486	kg. 256
320	inches	12.00	4.12	11.63	30.17	13.88	5.25	8.00	.66, SLOT	16.51	6.38	21.92	5.06	4.06	10.38	6" 150#	5.37	2.375	0.625	8.00	16.00	22.38	lb. 900
	mm	305	105	295	766	353	133	203	17, SLOT	419	162	557	129	103	264	FLG	136	60.3	15.88	203	406	568	kg. 408
323	inches	12.00	4.12	11.63	30.17	13.88	5.25	8.00	.66, SLOT	16.51	6.88	21.92	5.06	4.06	10.38	6" 150#	5.37	2.375	0.625	8.00	16.00	22.38	lb. 900
	mm	305	105	295	766	353	133	203	17, SLOT	419	175	557	129	103	264	FLG	136	60.3	15.88	203	406	568	kg. 408

ZP2/ZP3 Dimensions

ZP2/ZP3 Model		A	B	C	D	E	F	G	H	I	J	K	L	M	N	PORT SIZE	P	Q	KEY +0.002 -0.000	R	S	OAH	Weight
6	inches	4.75	1.95	3.75	11.80	5.50	1.94	2.31	.41, SLOT	6.82	2.93	9.61	2.12	2.00	4.21	1"	2.79	0.875	0.1875	3.49	6.97	8.30	lb. 56
	mm	121	50	95	300	140	49	59	10, SLOT	173	74	244	54	51	107	25	71	22.2	4.76	89	177	211	kg. 25
15	inches	4.75	1.95	3.75	11.80	5.50	1.94	2.31	.41, SLOT	6.82	2.93	9.61	2.12	2.00	4.21	1½"	2.79	0.875	0.1875	3.49	6.97	8.30	lb. 56
	mm	121	50	95	300	140	49	59	10, SLOT	173	74	244	54	51	107	38	71	22.2	4.76	89	177	211	kg. 25
18	inches	4.75	2.18	3.75	12.49	5.50	1.94	2.31	.41, SLOT	6.82	2.93	9.84	2.12	2.00	4.21	1½"	3.02	0.875	0.1875	3.49	6.97	8.30	lb. 65
	mm	121	55	95	317	140	49	59	10, SLOT	173	74	250	54	51	107	38	77	22.2	4.76	89	177	211	kg. 30
30	inches	6.25	2.78	4.25	14.58	6.86	2.31	2.56	.41, SLOT	7.77	3.56	11.61	2.62	2.32	5.21	1½"	3.84	1.25	0.250	4.25	8.50	10.29	lb. 130
	mm	159	71	108	370	174	59	65	10, SLOT	197	90	295	67	59	132	38	98	31.8	6.35	108	216	261	kg. 59
40	inches	6.25	2.94	4.25	14.87	6.86	2.31	2.56	.41, SLOT	7.77	3.56	11.99	2.62	2.32	5.21	2"	4.00	1.25	0.250	4.31	8.62	10.29	lb. 140
	mm	159	75	108	378	174	59	65	10, SLOT	197	90	305	67	59	132	51	102	31.8	6.35	109	219	261	kg. 64
45	inches	8.25	3.86	5.87	18.56	9.56	3.50	4.12	0.53	10.13	5.06	14.86	3.50	2.25	7.31	2"	4.73	1.625	0.375	5.37	10.75	15.31	lb. 265
	mm	210	98	149	471	243	89	105	13	257	129	377	89	57	186	51	120	41.3	9.53	136	273	389	kg. 120
60	inches	8.25	4.14	5.87	19.32	9.56	3.50	4.12	0.53	10.13	5.06	15.14	3.50	2.25	7.31	2½"	5.01	1.625	0.375	5.37	10.75	15.31	lb. 285
	mm	210	105	149	491	243	89	105	13	257	129	385	89	57	186	64	127	41.3	9.53	136	273	389	kg. 129
130	inches	8.25	4.78	5.87	20.33	9.56	3.50	4.12	0.53	10.13	5.06	15.77	3.50	2.25	7.31	3"	5.65	1.625	0.375	5.37	10.75	15.31	lb. 305
	mm	210	121	149	516	243	89	105	13	257	129	401	89	57	186	76	144	41.3	9.53	136	273	389	kg. 138
180	inches	8.50	3.45	9.00	23.53	12.38	3.75	7.25	.53, SLOT	14.05	6.38	18.25	4.50	2.75	9.38	3"	4.20	2.00	0.500	6.53	13.06	19.13	lb. 520
	mm	216	88	229	598	314	95	184	13, SLOT	357	162	464	114	70	238	76	107	50.8	12.70	166	332	486	kg. 236
220	inches	8.50	3.69	9.00	24.27	12.38	3.75	7.25	.53, SLOT	14.05	6.38	18.49	4.50	2.75	9.38	4"	4.44	2.00	0.500	6.63	13.25	19.13	lb. 590
	mm	216	94	229	616	314	95	184	13, SLOT	357	162	470	114	70	238	102	113	50.8	12.70	168	337	486	kg. 268
210	inches	12.00	3.45	11.63	27.08	13.88	5.25	8.00	.66, SLOT	16.51	6.88	21.24	5.06	4.06	10.38	4"	4.70	2.38	0.625	7.38	14.75	22.38	lb. 802
	mm	305	88	295	688	353	133	203	17, SLOT	419	175	539	129	103	264	102	119	60.5	15.88	187	375	568	kg. 364
320	inches	12.00	3.84	11.63	27.66	13.88	5.25	8.00	.66, SLOT	16.51	6.88	21.24	5.06	4.06	10.38	6" 150#	5.09	2.38	0.625	8.00	16.00	22.38	lb. 850
	mm	305	98	295	703	353	133	203	17, SLOT	419	175	539	129	103	264	FLG	129	60.5	15.88	203	406	568	kg. 386

