

Ampco Pumps Company

ZP Series Pumps

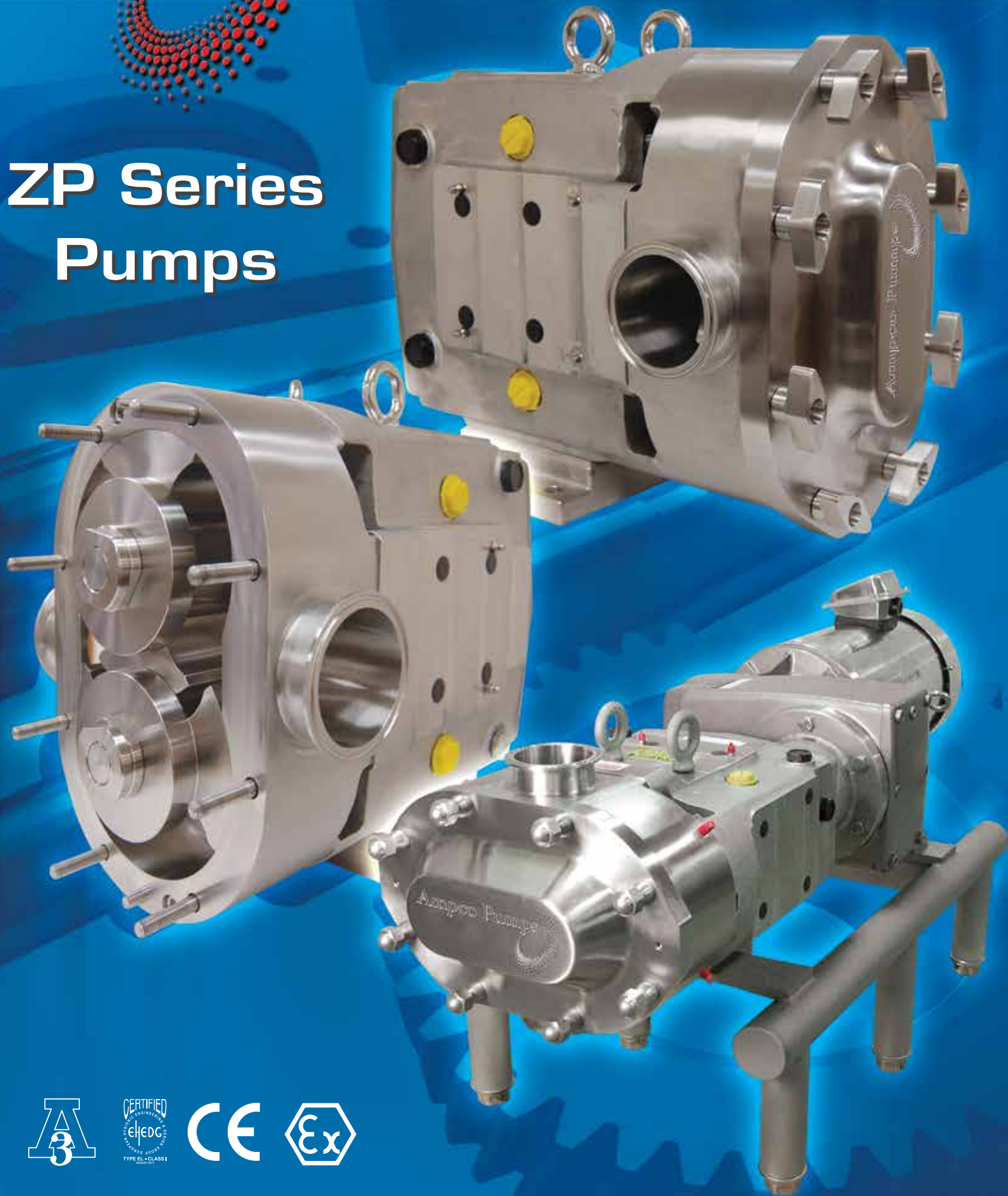

ZP Series PUMPS

Ampco is setting a new standard for the sanitary pump market. The ZP pump series offers more standard features than the competition including a 304SS gear case. ZP1 and ZP2 parts are interchangeable with competitor pumps.

The Ampco ZP3 is a true innovation and offers front loading seals for easy maintenance. The patent pending ZP3 offers a seal design that eliminates all dead zones and is fully CIP-able without modifications.

Remanufacturing Program:

All ZP Series and competing models can be rebuilt with oversized rotors to extend the useful life of the pump. A completely remanufactured pump includes new shafts, gears, bearings, rotors and a one-year factory warranty.



Available Options:
Rectangular inlets, heating jackets, pressure relief valves and optional rotor designs



ZP1 and ZP2 pumps are dimensionally and hydraulically interchangeable with competing brands. Visit our website at www.ampcopumps.com for a part number cross reference list.

PERFORMANCE

- Capacity Range: 0.1 to 310 gpm (0.02 to 70.4 m³/hr)

- Pressure Range:
up to 500 psi/ 34 Bar

- Temperature Range: -40°F to +300°F (-40°C to +150°C)

Note: Hot clearances required for high temp operation

- Viscosity Range:
28 to 910,000 SSU
(1 to 200,000 cSt)

Note: Consult factory for application greater than 910,000 SSU/200,000 cSt

- Chocolate clearance rotors in stock

ZP1/ZP2/ZP3 APPLICATIONS

BAKERY

- dough • fats • fruit filling • icing • oils • yeast

BEVERAGES

- beer • fruit concentrate • fruit juices • mash

CANDY

- chocolate • cocoa butter • corn syrup • gelatin • sugars

CANNED FOODS

- baby food • jams • jellies • mayonnaise • potato salad • pudding • relish • stews

COSMETICS

- creams • emulsions • jellies • lotions • shampoo • toothpaste

DAIRY

- butter • cream • curds • ice cream • margarine • milk • soft cheese • yogurt

DRESSINGS

- mayonnaise • many other sauces

FLAVORINGS

- concentrates • syrups

INDUSTRIAL

- auto paint • inks • latex • polymers

MEATS

- broth • fats • gelatin • pet foods • sausage fillings



IN-HOUSE CAPABILITIES



Ampco machines all cast parts in-house which allows us to control scheduling based on customer needs. Our state-of-the-art finishing department includes welding and polishing, so we maintain control throughout the manufacturing process.

Parts are inspected for quality and appearance before proceeding to the shelves in the warehouse. Ampco keeps a large inventory supply on the shelves to insure prompt deliveries. All pumps are tested prior to shipment.

AMPCO'S *NEW* ZP3 SERIES

Save time, money, training resources and inventory expense by switching or upgrading to *Ampco's NEW ZP3* series.

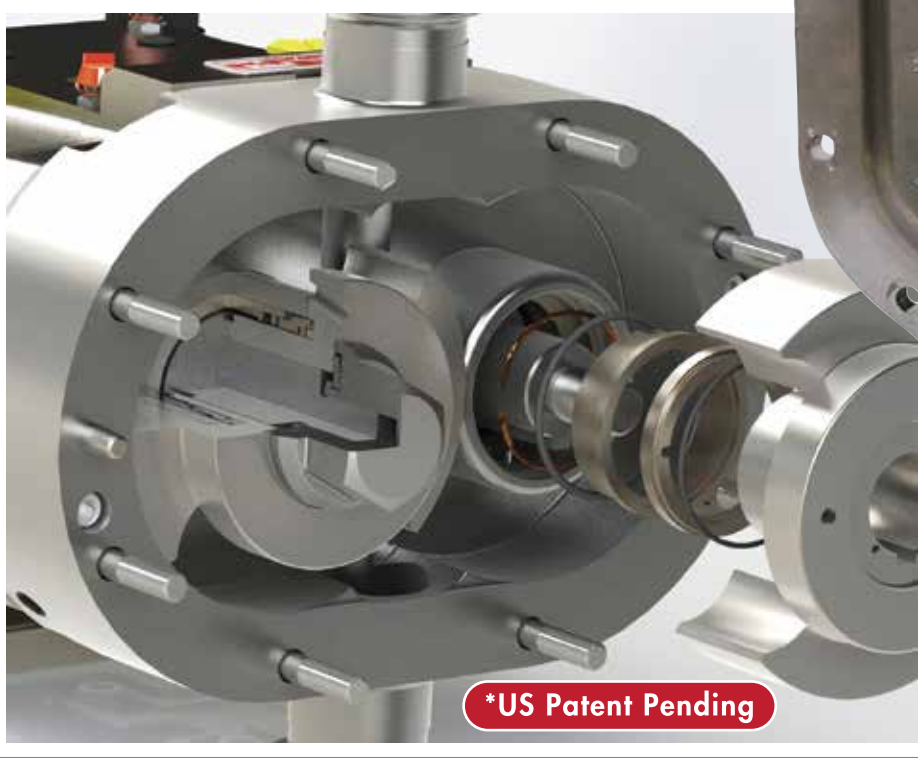

- Front-loading seals are located closer to the product flow, offering improved CIP-ability with no disassembly required.
- Front-loading seals allow for ease of maintenance and reduced service time.
- EHEDG certified and in conformance with 3A sanitary standards and the ATEX directive.
- Cover design maximizes exposure of the cover o-ring to the CIP fluid.
- Free drain design improves CIP-ability while maintaining maximum pump efficiency.
- CIP holes in rotor ensure turbulent flow to the cover hub.
- Elimination of dead zones in shaft bore improves cleanability and increases seal life.
- The ZP3 pump is mounted on a ZP2 gear case, including shafts, to maximize parts interchangeability.
- Existing ZP2 pumps (and our competitors' similar pumps) can be upgraded to the ZP3 design with new rotors, new seals and re-machining the existing rotor case.
- New pumps can be reconditioned 2 to 3 times.

For additional information on the ZP3 series and other Ampco Pumps products, please visit www.ampcopumps.com.



The AMPCO Advantage

SAMPLE ZP3 COMPARISION CURVES

Ampco ZP3-30

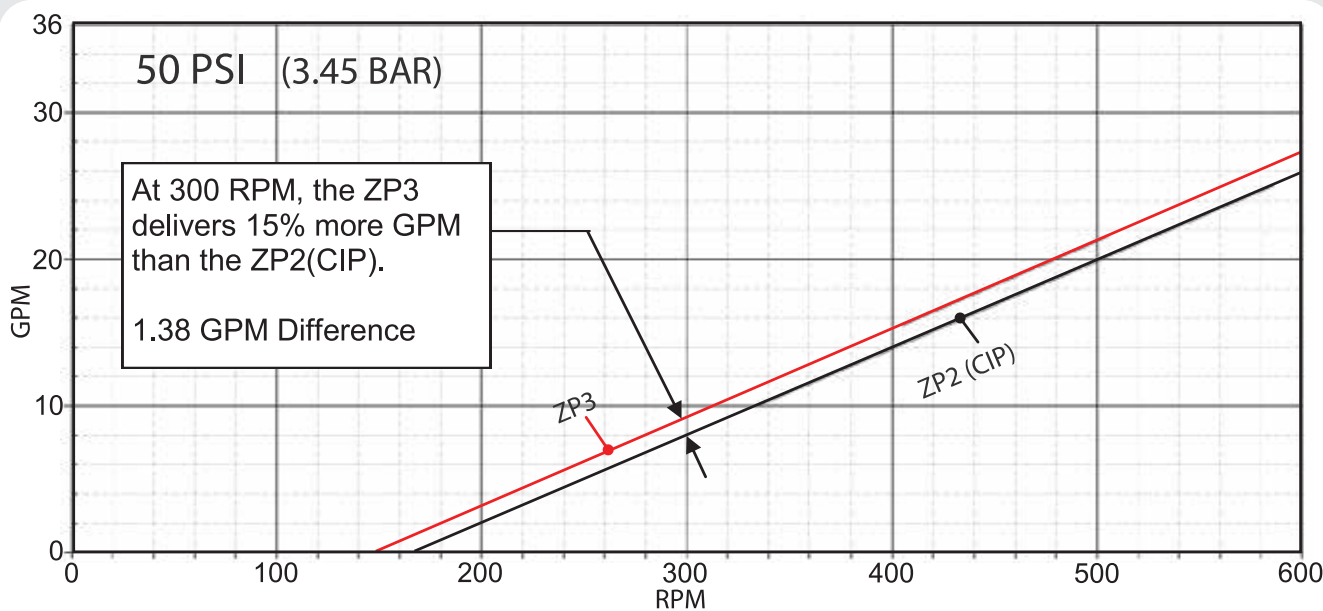

Ampco ZP3-130

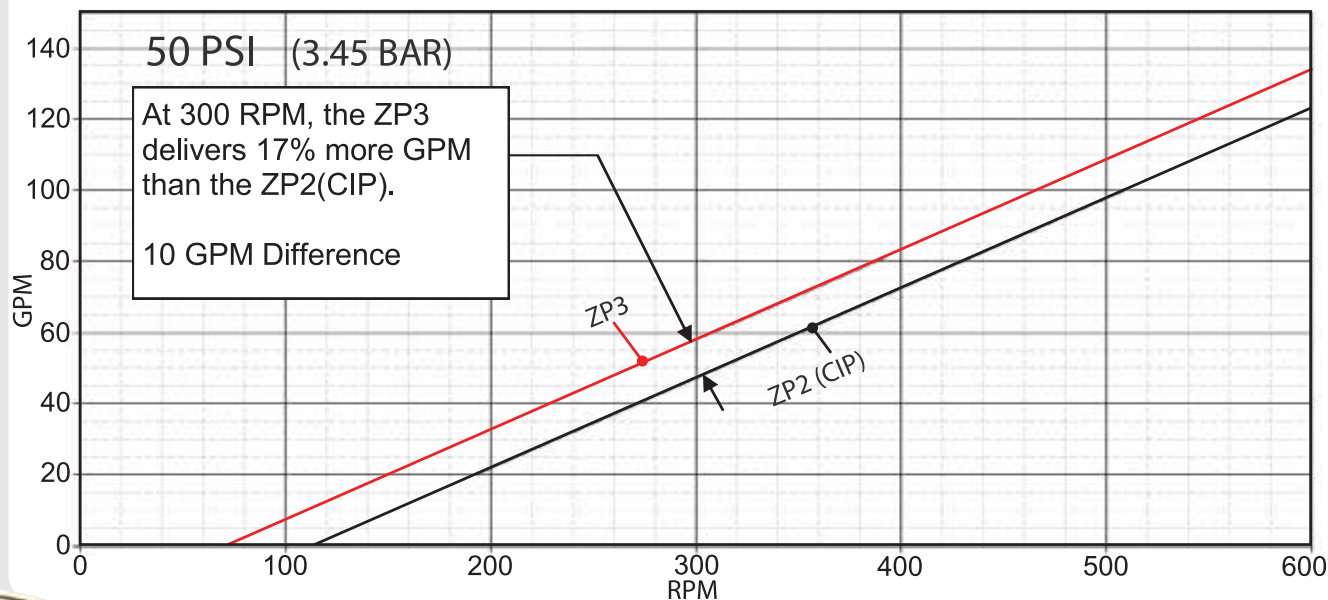

Ampco ZP Advantages

Only Ampco ZP pumps offer all of these upgrades at no additional charge

- Stainless Steel Gearcase
- Stainless Steel Retainers
- 17-4ph Shafts
- Helical Gears
- 4-Way Mounting
- 2-Side Threaded Grease Zerks
- Anti-Microbial Lube
- 6 Oil Fill Plugs with sight glass
- Gasketed Clean-Out Plugs

All ZP pumps include a 304 stainless steel gear case, providing high-resistance to corrosion and compatibility with caustic agents

Tapered roller bearings maintain axial forces for equal support in both directions

Solid 17-4ph stainless steel shafts on models 30 and larger, provide twice the tensile strength of 316L

Separate oil chamber for gears using anti-microbial lube

Helical timing gears for increased load carrying capacity and reduced noise

Stainless steel bearing retainer prevents corrosion and enhances bearing protection

Alloy 88 rotors provide non-galling characteristics to maintain tight tolerances. Optional clearances available

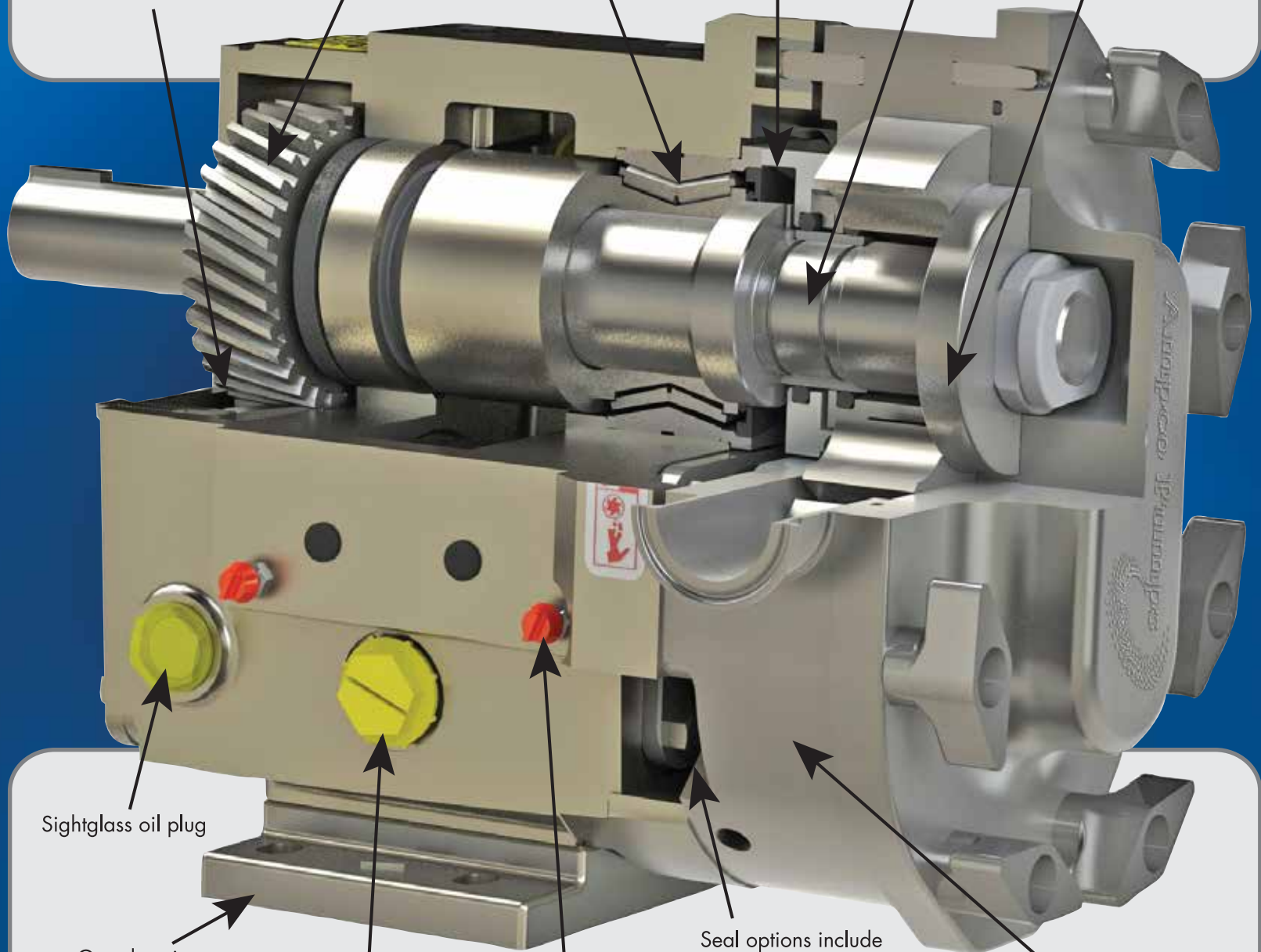

Sightglass oil plug

Gear housing designed to mount pump in four positions:

- Side mount left hand
- Side mount right hand
- Lower drive
- Upper drive

Sealed cleanout plugs protect and extend bearing life

Threaded grease fitting for easy replacement

Seal options include single and double mechanical seals, o-ring seals and lip seals

Pump housing and cover are constructed of 316L stainless steel

All stainless steel hardware prevents corrosion and stripped bolts

AMPCO ZP PUMP TECHNICAL DATA

ZP1 Pump Performance	ZP1 Model	Nominal Capacity		Displacement		Max. Differential Pressure		Standard Connection Size		Optional Connection Size		Max. Speed Rev / min	Temperature Range	
		GPM	M ³ /hr	Gallons / rev	Liters / rev	PSI	Bar	in.	mm	in.	mm		°F	°C
	6	7	1.6	.0082	.031	200	13.8	1"	25	1½"	38	800	-40° to 300°	-40° to 149°
	15	10	2.3	.0142	.054	200	13.8	1½"	38	-	-	700		
	18	17	3.9	.029	.110	200	13.8	1½"	38	2"	51	600		
	30	36	8.2	.060	.227	200	13.8	1½"	38	2"	51	600		
	40	46	10.4	.076	.288	150	10.3	2"	51	2½"	64	600		
	60	92	20.9	.153	.579	200	13.8	2½"	64	3"	76	600		
	130	152	34.5	.254	.961	200	13.8	3"	76	-	-	600		
	220	313	71.1	.522	1.976	200	13.8	4"	102	-	-	600		
320	452	103	.754	2.854	200	13.8	6"	152	-	-	600			
323	370	84	.616	2.332	225	15.5	6"	152	-	-	600			

ZP1 Model	Nominal Capacity		Displacement		Max. Differential Pressure		Rec. Inlet (W x L)		Outlet		Max. Speed Rev/min	Temperature Range	
	GPM	M ³ /hr	Gallons rev	Liters / rev	PSI	Bar	inches	mm	in.	mm		°F	°C
34	24	5.5	.060	.227	200	13.8	1.75 x 6.75	44 x 171	2"	51	400	-40° to 300°	-40° to 149°
64	61	13.9	.153	.579	200	13.8	2.24 x 8.82	57 x 224	2½" (3")	64 (76)	400		
134	102	23.2	.254	.961	200	13.8	2.97 x 9.25	75 x 235	3"	76	400		
224	208	47.2	.521	1.972	200	13.8	3.87 x 11	98 x 279	4"	102	400		

ZP2/ZP3 Pump Performance	ZP2/ZP3 Model	Nominal Capacity		Displacement		Max. Differential Pressure		Standard Connection Size		Optional Connection Size		Max. Speed Rev / min	Temperature Range	
		GPM	M ³ /hr	Gallons / rev	Liters / rev	PSI	Bar	in.	mm	in.	mm		°F	°C
	6	8	1.8	.0082	.031	300	20.7	1"	25	1½"	38	1000	-40° to 300°	-40° to 149°
	15	11	2.5	.0142	.054	250	17.2	1½"	38	-	-	800		
	18	20	4.5	.029	.110	200	13.8	1½"	38	2"	51	700		
	30	36	8.2	.060	.227	250	17.2	1½"	38	2"	51	600		
	40	46	10.4	.076	.288	150	10.3	2"	51	2½"	64	600		
	45	59	13.4	.098	.371	450	31.0	2"	51	-	-	600		
	60	92	20.9	.153	.579	300	20.7	2½"	64	3"	76	600		
	130	152	34.5	.254	.961	200	13.8	3"	76	-	-	600		
180	228	51.8	.380	1.438	450	31.0	3"	76	-	-	600			
220	313	71.1	.522	1.976	300	20.7	4"	102	-	-	600			
210	301	68.4	.502	1.900	500	34.5	4"	102	-	-	600			
320	452	103	.754	2.854	300	20.7	6"	152	-	-	600			

ZP2 Model	Nominal Capacity		Displacement		Max. Differential Pressure		Rec. Inlet (W x L)		Outlet		Max. Speed Rev/min	Temperature Range	
	GPM	M ³ /hr	rev	Liters / rev	PSI	Bar	inches	mm	in.	mm		°F	°C
34	24	5.5	.060	.227	250	17.2	1.81 x 6.84	46 x 174	2"	51	400	-40° to 300°	-40° to 149°
64	61	13.9	.153	.579	300	20.7	2.44 x 9.0	62 x 229	2½" (3")	64 (76)	400		
134	102	23.2	.254	.961	200	13.8	3.19 x 9.38	81 x 238	3"	76	400		
224	208	47.2	.521	1.972	300	20.7	4.06 x 11.25	103 x 286	4"	102	400		

ZP1 Dimensions

ZP1 Model		A	B	C	D	E	F	G	H	I	J	K	L	M	N	PORT SIZE	P	Q	KEY +0.002 -0.000	R	S	OAH	Weight
6	inches	4.75	1.95	3.75	12.04	5.50	1.94	2.31	.41, SLOT	6.82	2.93	9.61	2.12	2.00	4.21	1"	2.79	0.875	0.1875	3.49	6.97	8.30	lb. 60
	mm	121	50	95	306	140	49	59	10, SLOT	173	74	244	54	51	107	25	71	22.2	4.76	89	177	211	kg. 27
15	inches	4.75	1.95	3.75	12.04	5.50	1.94	2.31	.41, SLOT	6.82	2.93	9.61	2.12	2.00	4.21	1½"	2.79	0.875	0.1875	3.49	6.97	8.30	lb. 60
	mm	121	50	95	306	140	49	59	10, SLOT	173	74	244	54	51	107	38	71	22.2	4.76	89	177	211	kg. 27
18	inches	4.75	2.18	3.75	12.46	5.50	1.94	2.31	.41, SLOT	6.82	2.93	9.84	2.12	2.00	4.21	1½"	3.02	0.875	0.1875	3.55	7.09	8.30	lb. 64
	mm	121	55	95	316	140	49	59	10, SLOT	173	74	250	54	51	107	38	77	22.2	4.76	90	180	211	kg. 29
30	inches	6.25	2.78	4.25	14.58	6.86	2.31	2.56	.41, SLOT	7.77	3.56	11.61	2.62	2.32	5.21	1½"	3.84	1.25	0.250	4.25	8.50	10.29	lb. 130
	mm	159	71	108	370	174	59	65	10, SLOT	197	90	295	67	59	132	38	98	31.8	6.35	108	216	261	kg. 59
40	inches	6.25	2.94	4.25	14.96	6.86	2.31	2.56	.41, SLOT	7.77	3.56	11.99	2.62	2.32	5.21	2"	4.00	1.25	0.250	4.31	8.62	10.29	lb. 140
	mm	159	75	108	380	174	59	65	10, SLOT	197	90	305	67	59	132	51	102	31.8	6.35	109	219	261	kg. 64
60	inches	8.25	4.14	5.87	18.91	9.56	3.50	4.12	0.53	10.13	5.06	15.14	3.50	2.25	7.31	2½"	5.01	1.625	0.375	5.37	10.75	15.31	lb. 285
	mm	210	105	149	480	243	89	105	13	257	129	385	89	57	186	64	127	41.3	9.53	136	273	389	kg. 129
130	inches	8.25	4.78	5.87	19.85	9.56	3.50	4.12	0.53	10.13	5.06	15.77	3.50	2.25	7.31	3"	5.65	1.625	0.375	5.37	10.75	15.31	lb. 305
	mm	210	121	149	504	243	89	105	13	257	129	401	89	57	186	76	144	41.3	9.53	136	273	389	kg. 138
220	inches	8.50	3.69	9.00	23.37	12.38	3.75	7.25	.53, SLOT	14.05	6.38	18.49	4.50	2.75	9.38	4"	4.44	2.00	0.500	6.63	13.25	19.13	lb. 565
	mm	216	94	229	594	314	95	184	13, SLOT	357	162	470	114	70	238	102	113	50.8	12.70	168	337	486	kg. 256
320	inches	12.00	4.12	11.63	30.17	13.88	5.25	8.00	.66, SLOT	16.51	6.88	21.92	5.06	4.06	10.38	6" 150#	5.37	2.375	0.625	8.00	16.00	22.38	lb. 900
	mm	305	105	295	766	353	133	203	17, SLOT	419	175	557	129	103	264	FLG	136	60.3	15.88	203	406	568	kg. 408
323	inches	12.00	4.12	11.63	30.17	13.88	5.25	8.00	.66, SLOT	16.51	6.88	21.92	5.06	4.06	10.38	6" 150#	5.37	2.375	0.625	8.00	16.00	22.38	lb. 900
	mm	305	105	295	766	353	133	203	17, SLOT	419	175	557	129	103	264	FLG	136	60.3	15.88	203	406	568	kg. 408

ZP2/ZP3 Dimensions

ZP2/ZP3 Model		A	B	C	D	E	F	G	H	I	J	K	L	M	N	PORT SIZE	P	Q	KEY +0.002 -0.000	R	S	OAH	Weight
6	inches	4.75	1.95	3.75	11.80	5.50	1.94	2.31	.41, SLOT	6.82	2.93	9.61	2.12	2.00	4.21	1"	2.79	0.875	0.1875	3.49	6.97	8.30	lb. 56
	mm	121	50	95	300	140	49	59	10, SLOT	173	74	244	54	51	107	25	71	22.2	4.76	89	177	211	kg. 25
15	inches	4.75	1.95	3.75	11.80	5.50	1.94	2.31	.41, SLOT	6.82	2.93	9.61	2.12	2.00	4.21	1½"	2.79	0.875	0.1875	3.49	6.97	8.30	lb. 56
	mm	121	50	95	300	140	49	59	10, SLOT	173	74	244	54	51	107	38	71	22.2	4.76	89	177	211	kg. 25
18	inches	4.75	2.18	3.75	12.49	5.50	1.94	2.31	.41, SLOT	6.82	2.93	9.84	2.12	2.00	4.21	1½"	3.02	0.875	0.1875	3.49	6.97	8.30	lb. 65
	mm	121	55	95	317	140	49	59	10, SLOT	173	74	250	54	51	107	38	77	22.2	4.76	89	177	211	kg. 30
30	inches	6.25	2.78	4.25	14.58	6.86	2.31	2.56	.41, SLOT	7.77	3.56	11.61	2.62	2.32	5.21	1½"	3.84	1.25	0.250	4.25	8.50	10.29	lb. 130
	mm	159	71	108	370	174	59	65	10, SLOT	197	90	295	67	59	132	38	98	31.8	6.35	108	216	261	kg. 59
40	inches	6.25	2.94	4.25	14.87	6.86	2.31	2.56	.41, SLOT	7.77	3.56	11.99	2.62	2.32	5.21	2"	4.00	1.25	0.250	4.31	8.62	10.29	lb. 140
	mm	159	75	108	378	174	59	65	10, SLOT	197	90	305	67	59	132	51	102	31.8	6.35	109	219	261	kg. 64
45	inches	8.25	3.86	5.87	18.56	9.56	3.50	4.12	0.53	10.13	5.06	14.86	3.50	2.25	7.31	2"	4.73	1.625	0.375	5.37	10.75	15.31	lb. 265
	mm	210	98	149	471	243	89	105	13	257	129	377	89	57	186	51	120	41.3	9.53	136	273	389	kg. 120
60	inches	8.25	4.14	5.87	19.32	9.56	3.50	4.12	0.53	10.13	5.06	15.14	3.50	2.25	7.31	2½"	5.01	1.625	0.375	5.37	10.75	15.31	lb. 285
	mm	210	105	149	491	243	89	105	13	257	129	385	89	57	186	64	127	41.3	9.53	136	273	389	kg. 129
130	inches	8.25	4.78	5.87	20.33	9.56	3.50	4.12	0.53	10.13	5.06	15.77	3.50	2.25	7.31	3"	5.65	1.625	0.375	5.37	10.75	15.31	lb. 305
	mm	210	121	149	516	243	89	105	13	257	129	401	89	57	186	76	144	41.3	9.53	136	273	389	kg. 138
180	inches	8.50	3.45	9.00	23.53	12.38	3.75	7.25	.53, SLOT	14.05	6.38	18.25	4.50	2.75	9.38	3"	4.20	2.00	0.500	6.53	13.06	19.13	lb. 520
	mm	216	88	229	598	314	95	184	13, SLOT	357	162	464	114	70	238	76	107	50.8	12.70	166	332	486	kg. 236
220	inches	8.50	3.69	9.00	24.27	12.38	3.75	7.25	.53, SLOT	14.05	6.38	18.49	4.50	2.75	9.38	4"	4.44	2.00	0.500	6.63	13.25	19.13	lb. 590
	mm	216	94	229	616	314	95	184	13, SLOT	357	162	470	114	70	238	102	113	50.8	12.70	168	337	486	kg. 268
210	inches	12.00	3.45	11.63	27.08	13.88	5.25	8.00	.66, SLOT	16.51	6.88	21.24	5.06	4.06	10.38	4"	4.70	2.38	0.625	7.38	14.75	22.38	lb. 802
	mm	305	88	295	688	353	133	203	17, SLOT	419	175	539	129	103	264	102	119	60.5	15.88	187	375	568	kg. 364
320	inches	12.00	3.84	11.63	27.66	13.88	5.25	8.00	.66, SLOT	16.51	6.88	21.24	5.06	4.06	10.38	6" 150#	5.09	2.38	0.625	8.00	16.00	22.38	lb. 850
	mm	305	98	295	703	353	133	203	17, SLOT	419	175	539	129	103	264	FLG	129	60.5	15.88	203	406	568	kg. 386

